

Optocoupler with Phototransistor Output

Description

The CNY17 series consists of a phototransistor optically coupled to a gallium arsenide infrared-emitting diode in a 6-lead plastic dual in line package. The elements are mounted on one leadframe using a **coplanar technique**, providing a fixed distance between input and output for highest safety requirements.

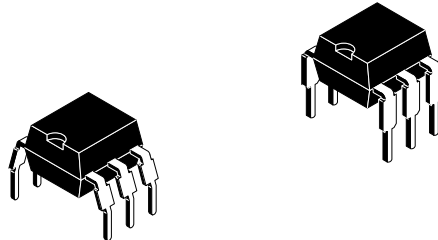

14827

Applications

Circuits for safe protective separation against electrical shock according to safety class II (reinforced isolation):

- For appl. class I – IV at mains voltage ≤ 300 V
- For appl. class I – III at mains voltage ≤ 600 V according to VDE 0884, table 2, suitable for:

Switch-mode power supplies, line receiver, computer peripheral interface, microprocessor system interface.

VDE Standards

These couplers perform safety functions according to the following equipment standards:

- **VDE 0884**
Optocoupler for electrical safety requirements
- **IEC 950/EN 60950**
Office machines (applied for reinforced isolation for mains voltage ≤ 400 V_{RMS})
- **VDE 0804**
Telecommunication apparatus and data processing
- **IEC 65** Safety for mains-operated electronic and related household apparatus

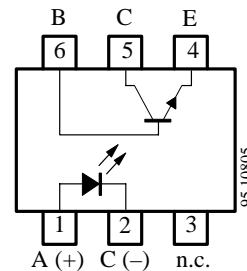

0884

Order Instruction

Ordering Code	CTR Ranking	Remarks
CNY17-1/ CNY17G-1 ¹⁾	40 to 80%	
CNY17-2/ CNY17G-2 ¹⁾	63 to 125%	
CNY17-3/ CNY17G-3 ¹⁾	100 to 200%	
CNY17-4/ CNY17G-4 ¹⁾	160 to 320%	
¹⁾ G = Leadform 10.16 mm; G is not market on the body		



Features

Approvals:

- **BSI:** BS EN 41003, BS EN 60095 (BS 415), BS EN 60950 (BS 7002), Certificate number 7081 and 7402
- **FIMKO (SETI):** EN 60950, Certificate number 12399
- **Underwriters Laboratory (UL)** 1577 recognized, file number E-76222
- **VDE 0884,** Certificate number 94778

VDE 0884 related features:

- Rated impulse voltage (transient overvoltage) $V_{IOTM} = 6$ kV peak
- Isolation test voltage (partial discharge test voltage) $V_{pd} = 1.6$ kV
- Rated isolation voltage (RMS includes DC) $V_{IOWM} = 600 V_{RMS}$ (848 V peak)

- Rated recurring peak voltage (repetitive) $V_{IORM} = 600 V_{RMS}$
- Creepage current resistance according to VDE 0303/IEC 112
Comparative Tracking Index: **CTI = 275**
- Thickness through insulation ≥ 0.75 mm

General features:

- Isolation materials according to UL94-VO
- Pollution degree 2 (DIN/VDE 0110 part 1 resp. IEC 664)
- Climatic classification 55/100/21 (IEC 68 part 1)
- Special construction:
Therefore, extra low coupling capacity of typical 0.3 pF, high **Common Mode Rejection**
- CTR offered in 4 groups
- Low temperature coefficient of CTR
- Coupling System A

Input (Emitter)

Parameter	Test Conditions	Symbol	Value	Unit
Reverse voltage		V_R	5	V
Forward current		I_F	60	mA
Forward surge current	$t_p \leq 10 \mu s$	I_{FSM}	3	A
Power dissipation	$T_{amb} \leq 25^\circ C$	P_V	100	mW
Junction temperature		T_j	125	$^\circ C$

Output (Detector)

Parameter	Test Conditions	Symbol	Value	Unit
Collector emitter voltage		V_{CEO}	32	V
Emitter collector voltage		V_{ECO}	7	V
Collector current		I_C	50	mA
Collector peak current	$t_p/T = 0.5, t_p \leq 10$ ms	I_{CM}	100	mA
Power dissipation	$T_{amb} \leq 25^\circ C$	P_V	150	mW
Junction temperature		T_j	125	$^\circ C$

Coupler

Parameter	Test Conditions	Symbol	Value	Unit
Isolation test voltage (RMS)		V_{IO}	3.75	kV
Total power dissipation	$T_{amb} \leq 25^\circ C$	P_{tot}	250	mW
Ambient temperature range		T_{amb}	-55 to +100	$^\circ C$
Storage temperature range		T_{stg}	-55 to +125	$^\circ C$
Soldering temperature	2 mm from case, $t \leq 10$ s	T_{sd}	260	$^\circ C$



Electrical Characteristics ($T_{amb} = 25^{\circ}\text{C}$)

Input (Emitter)

Parameter	Test Conditions	Symbol	Min.	Typ.	Max.	Unit
Forward voltage	$I_F = 50 \text{ mA}$	V_F		1.25	1.6	V
Junction capacitance	$V_R = 0, f = 1 \text{ MHz}$	C_j		50		pF

Output (Detector)

Parameter	Test Conditions	Symbol	Min.	Typ.	Max.	Unit
Collector emitter voltage	$I_C = 1 \text{ mA}$	V_{CEO}	32			V
Emitter collector voltage	$I_E = 100 \mu\text{A}$	V_{ECO}	7			V
Collector emitter cut-off current	$V_{CE} = 10 \text{ V}, I_f = 0$	I_{CEO}		10	100	nA

Coupler

Parameter	Test Conditions	Symbol	Min.	Typ.	Max.	Unit
AC isolation test voltage (RMS)	$f = 50 \text{ Hz}, t = 1 \text{ s}$	V_{IO}	3.75			V
Collector emitter saturation voltage	$I_F = 10 \text{ mA}, I_C = 1 \text{ mA}$	V_{CEsat}			0.3	V
Cut-off frequency	$V_{CE} = 5 \text{ V}, I_F = 10 \text{ mA}, R_L = 100 \Omega$	f_c		110		kHz
Coupling capacitance	$f = 1 \text{ MHz}$	c_k		0.3		pF

Current Transfer Ratio (CTR)

Parameter	Test Conditions	Type	Symbol	Min.	Typ.	Max.	Unit
I_C/I_F	$V_{CE} = 5 \text{ V}, I_F = 10 \text{ mA}$	CNY17(G)-1	CTR	0.4		0.8	
		CNY17(G)-2	CTR	0.63		1.25	
		CNY17(G)-3	CTR	1.0		2.0	
		CNY17(G)-4	CTR	1.6		3.2	
	$V_{CE} = 5 \text{ V}, I_F = 1 \text{ mA}$	CNY17(G)-1	CTR	0.13			
		CNY17(G)-2	CTR	0.22			
		CNY17(G)-3	CTR	0.34			
		CNY17(G)-4	CTR	0.56			

Maximum Safety Ratings (according to VDE 0884) see figure 1

This device is used for protective separation against electrical shock only within the maximum safety ratings. This must be ensured by using protective circuits in the applications.

Input (Emitter)

Parameters	Test Conditions	Symbol	Value	Unit
Forward current		I_{si}	130	mA

Output (Detector)

Parameters	Test Conditions	Symbol	Value	Unit
Power dissipation	$T_{amb} \leq 25^\circ\text{C}$	P_{si}	265	mW

Coupler

Parameters	Test Conditions	Symbol	Value	Unit
Rated impulse voltage		V_{IOTM}	6	kV
Safety temperature		T_{si}	150	$^\circ\text{C}$

Insulation Rated Parameters (according to VDE 0884)

Parameter	Test Conditions	Symbol	Min.	Typ.	Max.	Unit
Partial discharge test voltage – Routine test	100%, $t_{test} = 1\text{ s}$	V_{pd}	1.6			kV
Partial discharge test voltage – Lot test (sample test)	$t_{Tr} = 60\text{ s}$, $t_{test} = 10\text{ s}$, (see figure 2)	V_{IOTM}	6			kV
		V_{pd}	1.3			kV
Insulation resistance	$V_{IO} = 500\text{ V}$	R_{IO}	10^{12}			Ω
	$V_{IO} = 500\text{ V}$, $T_{amb} = 100^\circ\text{C}$	R_{IO}	10^{11}			Ω
	$V_{IO} = 500\text{ V}$, $T_{amb} = 150^\circ\text{C}$ (construction test only)	R_{IO}	10^9			Ω

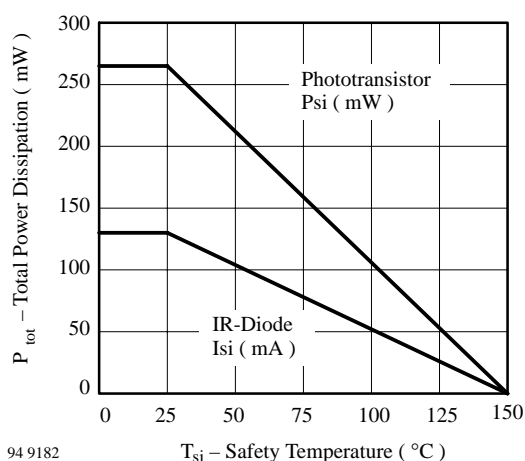

Figure 1. Derating diagram

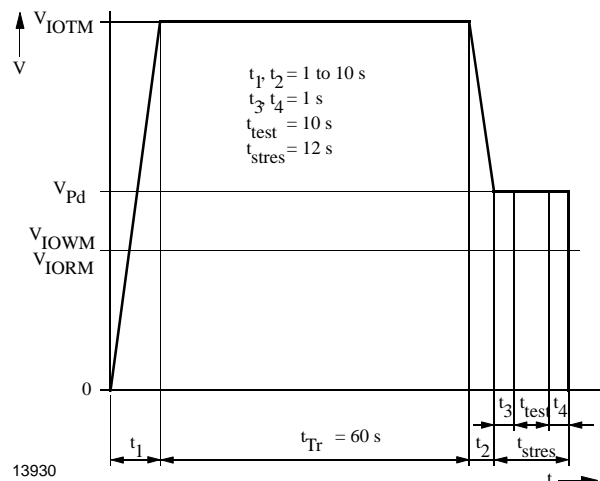

Figure 2. Test pulse diagram for sample test according to DIN VDE 0884

Switching Characteristics

Parameter	Test Conditions	Symbol	Typ.	Unit
Delay time	$V_S = 5\text{ V}$, $I_C = 5\text{ mA}$, $R_L = 100\ \Omega$ (see figure 3)	t_d	4.0	μs
Rise time		t_r	7.0	μs
Fall time		t_f	6.7	μs
Storage time		t_s	0.3	μs
Turn-on time	$V_S = 5\text{ V}$, $I_F = 10\text{ mA}$, $R_L = 1\text{ k}\Omega$ (see figure 4)	t_{on}	11.0	μs
Turn-off time		t_{off}	7.0	μs
Turn-on time		t_{on}	25	μs
Turn-off time		t_{off}	42.5	μs

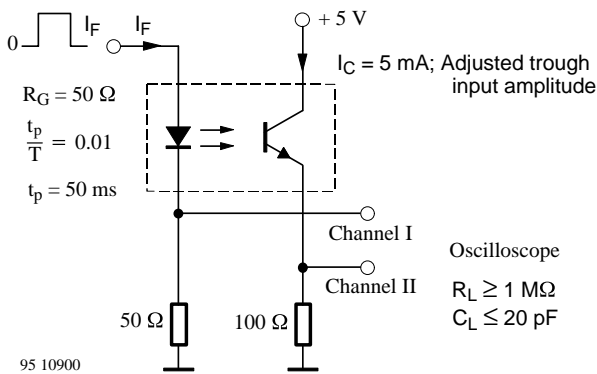

Figure 3. Test circuit, non-saturated operation

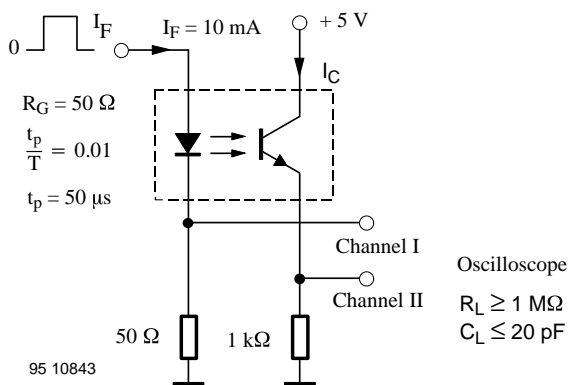

Figure 4. Test circuit, saturated operation

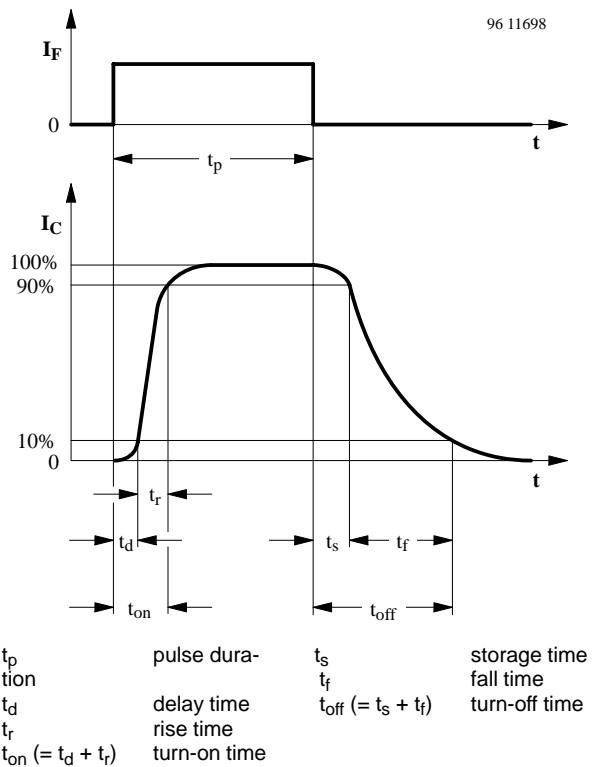

Figure 5. Switching times

Typical Characteristics ($T_{amb} = 25^{\circ}\text{C}$, unless otherwise specified)

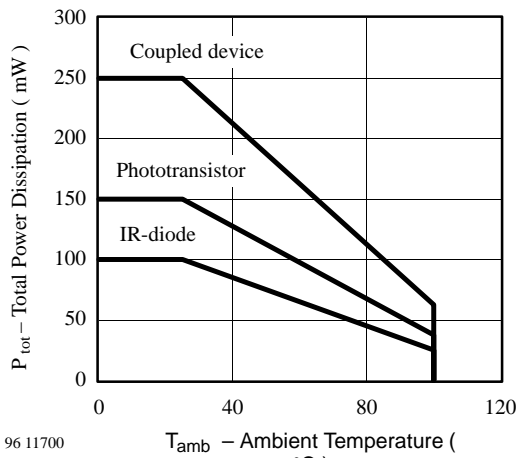

Figure 6. Total Power Dissipation vs. Ambient Temperature

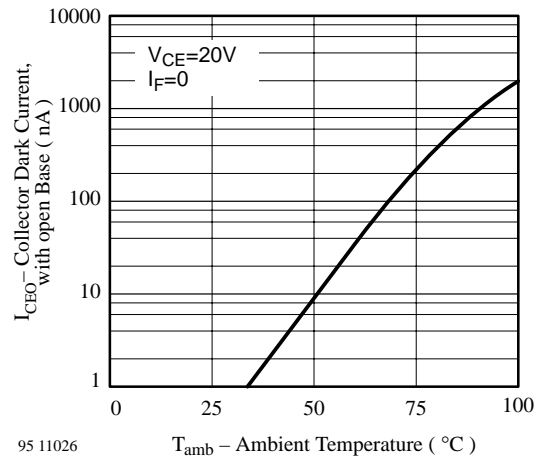

Figure 9. Collector Dark Current vs. Ambient Temperature

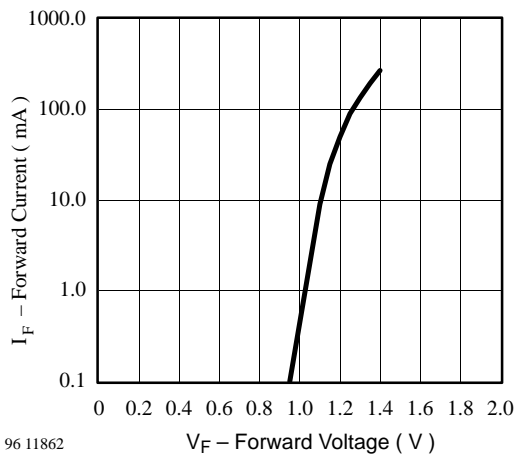

Figure 7. Forward Current vs. Forward Voltage

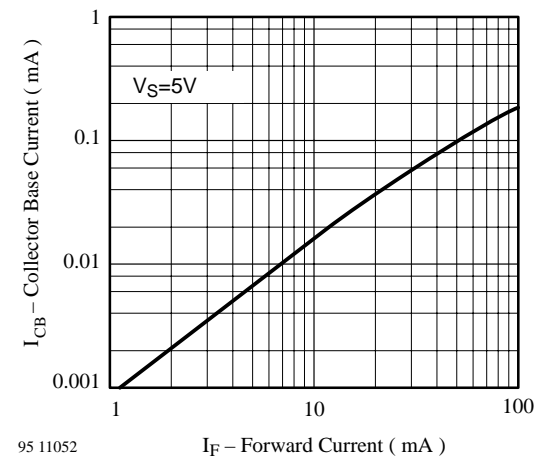

Figure 10. Collector Base Current vs. Forward Current

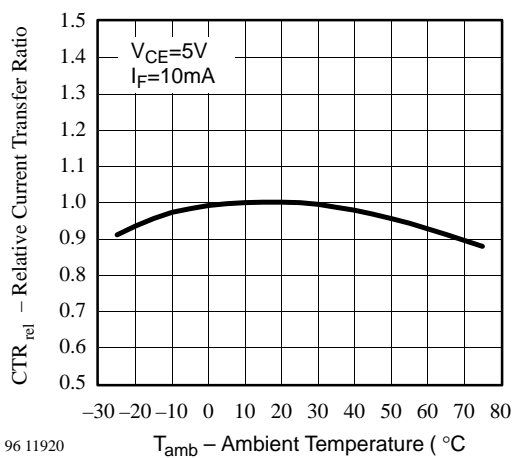

Figure 8. Relative Current Transfer Ratio vs. Ambient Temperature

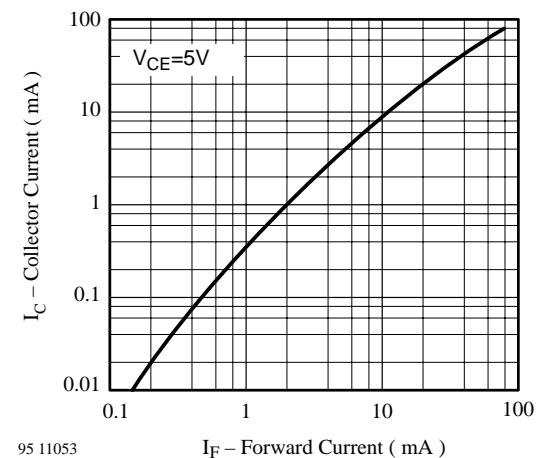

Figure 11. Collector Current vs. Forward Current

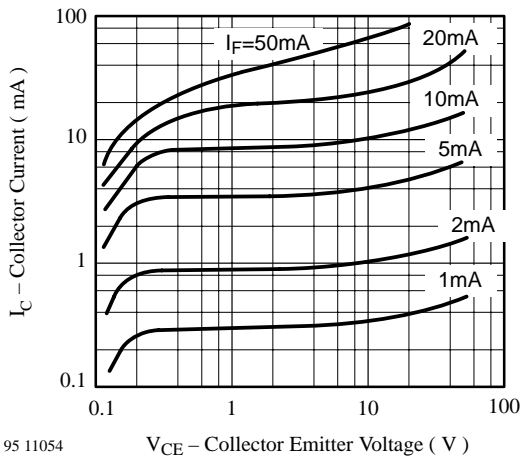

Figure 12. Collector Current vs. Collector Emitter Voltage

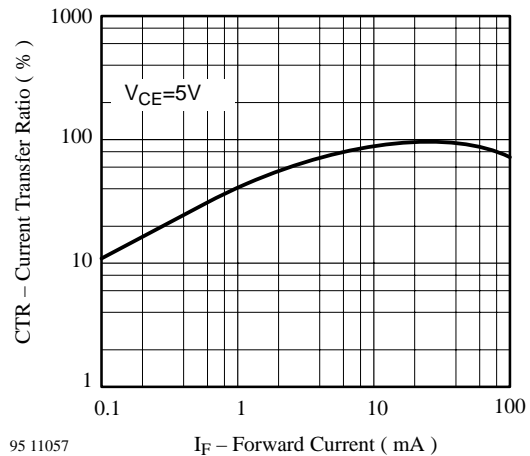

Figure 15. Current Transfer Ratio vs. Forward Current

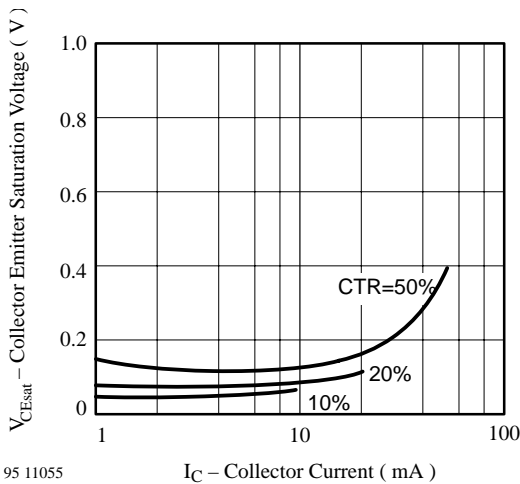

Figure 13. Collector Emitter Saturation Voltage vs. Collector Current

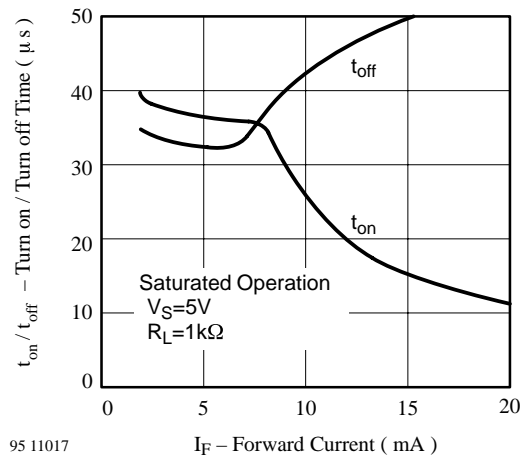

Figure 16. Turn on / off Time vs. Forward Current

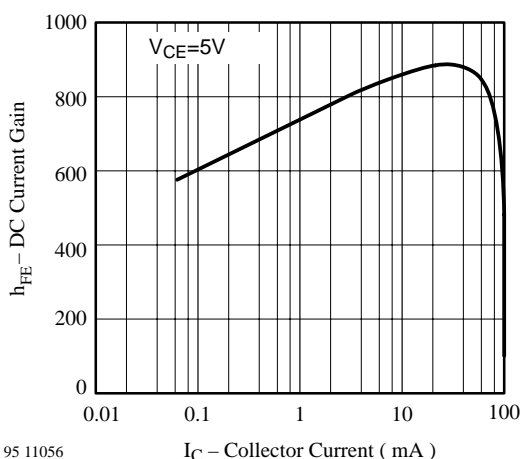

Figure 14. DC Current Gain vs. Collector Current

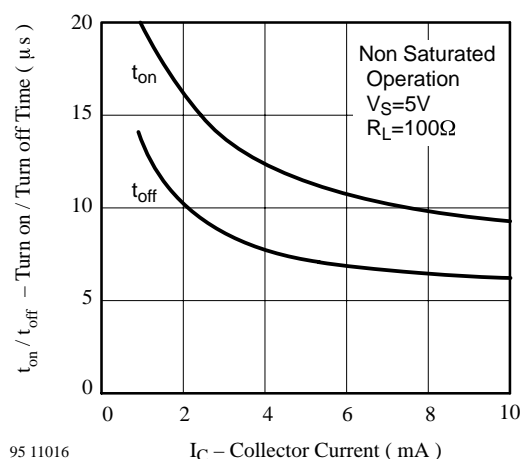

Figure 17. Turn on / off Time vs. Collector Current

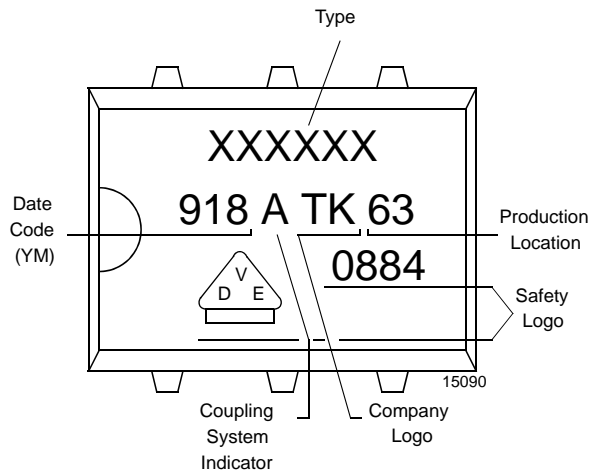
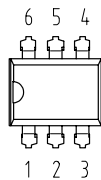
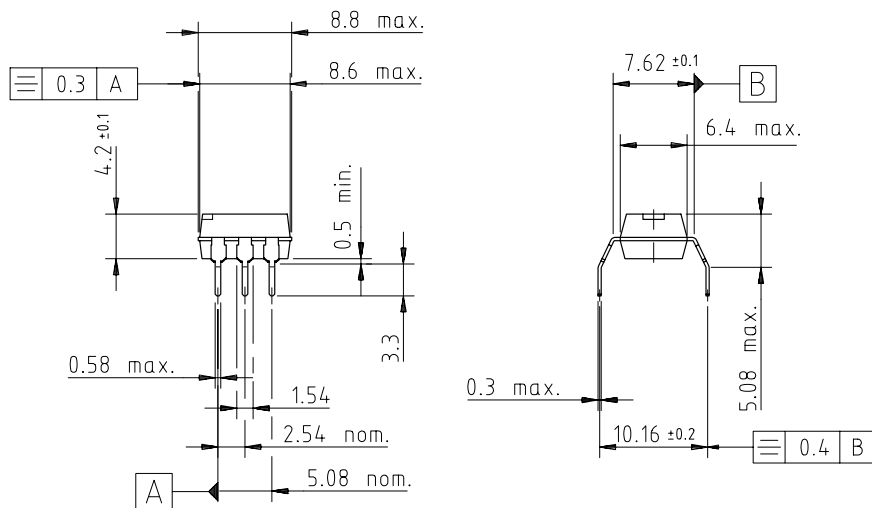

Figure 18. Marking example

Dimensions of CNY17G in mm



weight: ca. 0.50 g
 creepage distance: \approx 8 mm
 air path: \geq 8 mm

after mounting on PC board

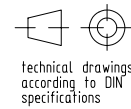

14771

Dimensions of CNY17 in mm

