

FS6S0965RC

Fairchild Power Switch(FPS)

Features

- Wide operating frequency range up to 150Khz
- Internal Burst mode Controller for Stand-by mode
- Pulse by pulse over current limiting
- Over current protection(Latch mode)
- Over voltage protection (Auto restart mode)
- Over load protection(Auto restart mode)
- Internal thermal shutdown function(Latch mode)
- Under voltage lockout
- Internal high voltage sense FET
- Eternal sync terminal/Soft start

Description

The Fairchild Power Switch(FPS) product family is specially designed for an off line SMPS with minimal external components. The Fairchild Power Switch(FPS) consist of high voltage power SenseFET and current mode PWM IC. Included PWM controller features integrated fixed oscillator, under voltage lock out, optimized gate turn on/turn off driver, thermal shut down protection, over voltage protection, and temperature compensated precision current sources for loop compensation and fault protection circuitry. compared to discrete MOSFET and controller or RCC switching converter solution, a Fairchild Power Switch(FPS) can reduce total component count, design size, and weight and at the same time increase efficiency, productivity, and system reliability. It has a basic platform well suited for cost effective monitor power supply.



Internal Block Diagram

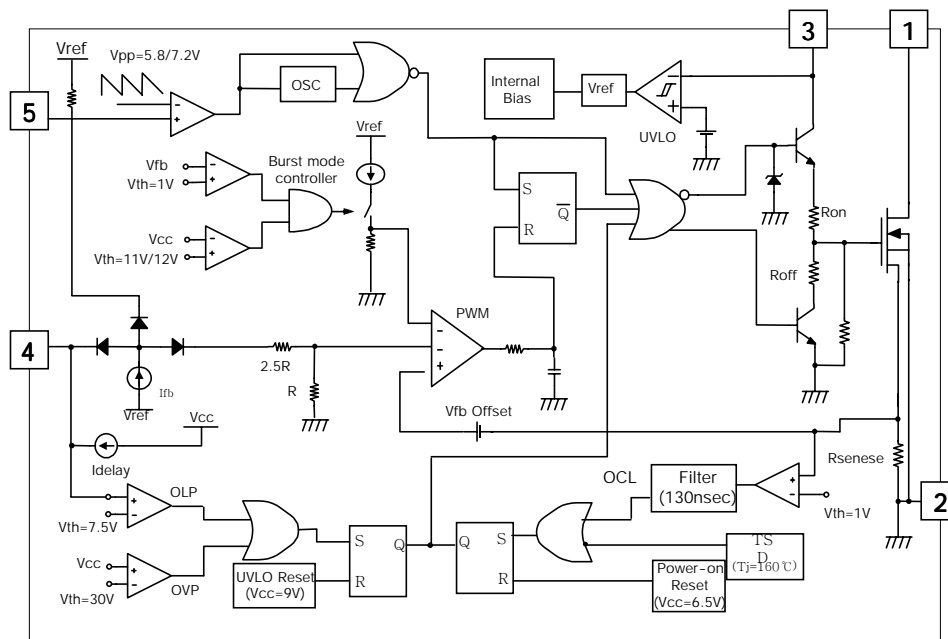

Absolute Maximum Ratings

(Ta=25°C, unless otherwise specified)

Parameter	Symbol	Value	Unit
Drain-source(GND) voltage ⁽¹⁾	V _{DSS}	650	V
Drain-Gate Voltage (R _{GS} =1MΩ)	V _{DGR}	650	V
Gate-source (GND) Voltage	V _{GS}	±30	V
Drain current pulsed ⁽²⁾	I _{DM}	32.4	ADC
Single pulsed avalanche energy ⁽³⁾	E _{AS}	515	mJ
Single Pulsed Avalanche current ⁽⁴⁾	I _{AS}	25	A
Continuous drain current (T _c = 25°C)	I _D	8.1	ADC
Continuous drain current (T _C =100°C)	I _D	5.1	ADC
Supply voltage	V _{CC}	35	V
Input Voltage Range	V _{FB}	-0.3 to V _{CC}	V
	V _{S_S}	-0.3 to 10	V
Total Power Dissipation	P _D (Watt H/S)	155	W
	Derating	1.243	W/°C
Operating junction temperature	T _j	+160	°C
Operating Ambient Temperature	T _A	-25 to +85	°C
Storage Temperature range	T _{STG}	-55 to +150	°C

Notes:

1. T_j=25°C to 150°C
2. Repetitive rating: Pulse width limited by maximum junction temperature
3. L=14.5mH, starting T_j=25°C
4. L=13uH, starting T_j=25°C

Electrical Characteristics (SFET part)

(Ta=25°C unless otherwise specified)

Parameter	Symbol	Condition	Min.	Typ.	Max.	Unit
Drain-source breakdown voltage	BV _{DSS}	V _{GS} = 0V, I _D = 250μA	650	-	-	V
Zero gate voltage drain current	I _{DSS}	V _{DS} = 650V, V _{GS} = 0V	-	-	200	μA
		V _{DS} = 520V V _{GS} = 0V, T _C = 125°C	-	-	300	μA
Static drain-source on resistance ^(note)	R _{DS(ON)}	V _{GS} = 10V, I _D = 1.8A	-	1.0	1.2	Ω
Forward transconductance ^(note)	g _{fs}	V _{DS} = 50V, I _D = 1.8A	-	-	-	S
Input capacitance	C _{iss}	V _{GS} = 0V, V _{DS} = 25V, f = 1MHz	-	1300	-	pF
Output capacitance	C _{oss}		-	135	-	
Reverse transfer capacitance	C _{rss}		-	25	-	
Turn on delay time	t _{d(on)}	V _{DD} = 325V, I _D = 6.5A (MOSFET switching time are essentially independent of operating temperature)	-	25	-	nS
Rise time	t _r		-	75	-	
Turn off delay time	t _{d(off)}		-	130	-	
Fall time	t _f		-	70	-	
Total gate charge (gate-source+gate-drain)	Q _g	V _{GS} = 10V, I _D = 6.5A, V _{DS} = 520V (MOSFET Switching time are Essentially independent of Operating temperature)	-	45	60	nC
Gate source charge	Q _{gs}		-	8	-	
Gate drain (Miller) charge	Q _{gd}		-	21	-	

Note:

Pulse test : Pulse width ≤ 300μS, duty 2%

$$S = \frac{1}{R}$$

Electrical Characteristics

(Ta=25°C unless otherwise specified)

Parameter	Symbol	Condition	Min.	Typ.	Max.	Unit
UVLO SECTION						
Start threshold voltage	VSTART	VFB = GND	14	15	16	V
Stop threshold voltage	VSTOP	VFB = GND	8	9	10	V
SENSEFET SECTION						
Drain to PKG Breakdown voltage	BVpkg	60HZ AC, Ta = 25°C	3500	-	-	V
Drain to Source Breakdown voltage	BVdss	Vdrain = 650V, Ta = 25°C	650	-	-	V
Drain to Source Leakage current	Idss	Vdrain = 650V, Ta = 25°C	-	-	300	uA
OSCILLATOR SECTION						
Initial Frequency	FOSC	-	22	25	28	kHz
Voltage Stability	FSTABLE	12V ≤ Vcc ≤ 23V	0	1	3	%
Temperature Stability (note4)	ΔFOSC	-25°C ≤ Ta ≤ 85°C	0	±5	±10	%
Maximum duty cycle	DMAX	-	92	95	98	%
Minimum Duty Cycle	DMIN	-	-	-	0	%
FEEDBACK SECTION						
Feedback source current	IFB	VFB = GND	0.7	0.9	1.1	mA
Shutdown Feedback voltage	VSD	Vfb ≥ 6.9V	6.9	7.5	8.1	V
Shutdown delay current	Idelay	VFB = 5V	1.6	2.0	2.4	μA
PROTECTION SECTION						
Over Voltage Protection	VOVP	Vsync ≥ 11V	27	30	33	V
Over Current Latch Voltage (Note2)	VOCL	-	0.9	1.0	1.1	V
Thermal Shutdown Temp.(Note4)	TSD	-	140	160	-	°C

Note:

- (1) These parameters is the current flowing in the Control IC.
- (2) These parameters, although guaranteed, are tested in EDS(wafer test) process.
- (3) These parameters indicate Inductor Current.
- (4) These parameters, although guranteed at the design, are not tested in massing production

Electrical Characteristics (Continued)

(Ta=25°C unless otherwise specified)

Parameter	Symbol	Condition	Min.	Typ.	Max.	Unit
Sync & SOFTSTART SECTION						
Softstart Voltage	VSS	Vfb = 2	4.7	5.0	5.3	V
Softstart Current	ISS	Vss = V	0.8	1.0	1.2	mA
Sync High Threshold Voltage	VSYNCH	Vcc = 16V, Vfb = 5V	-	7.2	-	V
Sync Low Threshold Voltage	VSYNCL	Vcc = 16V, Vfb = 5V	-	5.8	-	V
BURST MODE SECTION						
Burst mode Low Threshold Voltage	VBURL	Vfb = 0V	10.4	11.0	11.6	V
Burst mode High Threshold Voltage	VBURH	Vfb = 0V	11.4	12.0	12.6	V
Burst mode Enable Feedback Voltage(Note4)	VBEN	Vcc = 10.5V	0.7	1.0	1.3	V
Burst mode Peak Current Limit(Note3)	IBU_PK	Vcc = 10.5V	0.6	0.85	1.1	V
Burst mode Frequency	FBUR	Vcc = 10.5V, Vfb = 0V	40	50	60	KHz
CURRENT LIMIT(SELF-PROTECTION)SECTION						
Peak Current Limit(Note3)	IOVER	-	5.28	6.0	6.72	A
TOTAL DEVICE SECTION						
Start Up current	ISTART	Vfb = GND, VCC = 14V	-	0.1	0.17	mA
Operating supply current (Note1)	IOP	Vfb = GND, VCC = 16V	-	10	15	mA
	IOP(MIN)	Vfb = GND, VCC = 10V				
	IOP(MAX)	Vfb = GND, VCC = 28V				

Note:

- (1) These parameters is the current flowing in the Control IC.
- (2) These parameters, although guaranteed, are tested in EDS(wafer test) process.
- (3) These parameters indicate Inductor Current.
- (4) These parameters, although guranteed at the design, are not tested in massing production.

Typical Performance Characteristics

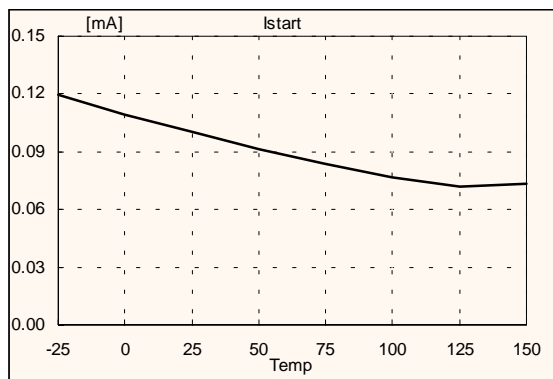

Figure 1. Start Up Current vs. Temp.

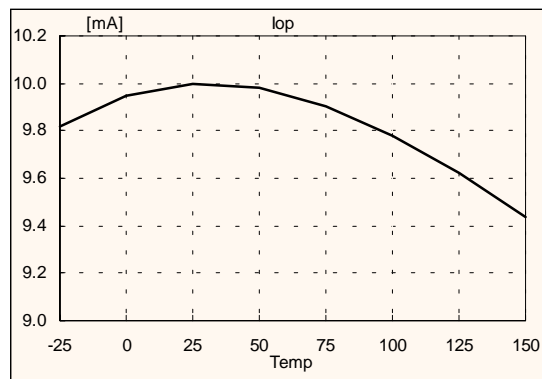

Figure 2. Operating Supply Current vs. Temp.

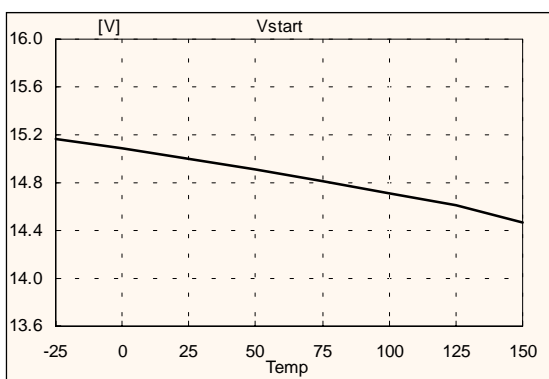

Figure 3. Start Threshold Voltage vs. Temp.

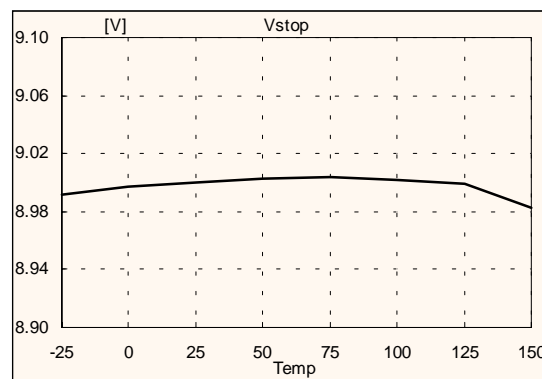

Figure 4. Stop Threshold Voltage vs. Temp.

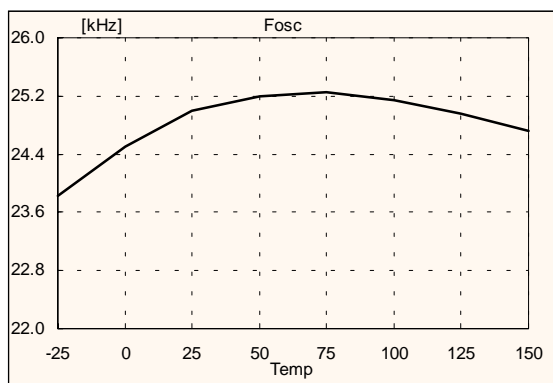

Figure 5. Initial Frequency vs. Temp.

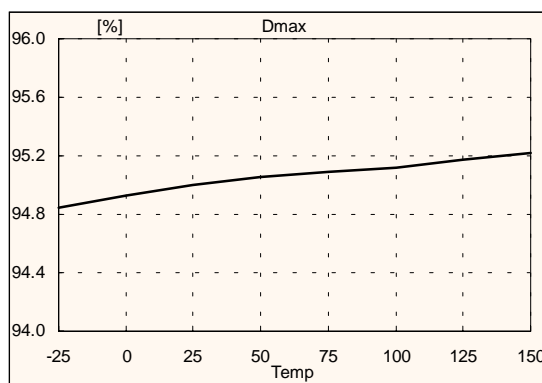

Figure 6. Maximum Duty vs. Temp.

Typical Performance Characteristics (Continued)

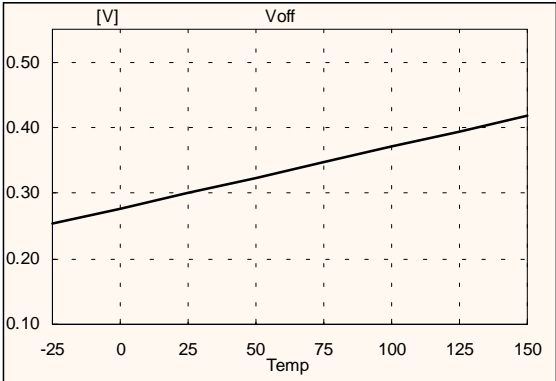

Figure 7. Feedback Offset Voltage vs. Temp.

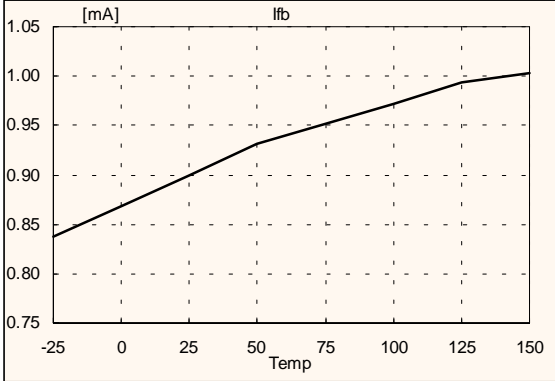

Figure 8. Feedback Source Current vs. Temp.

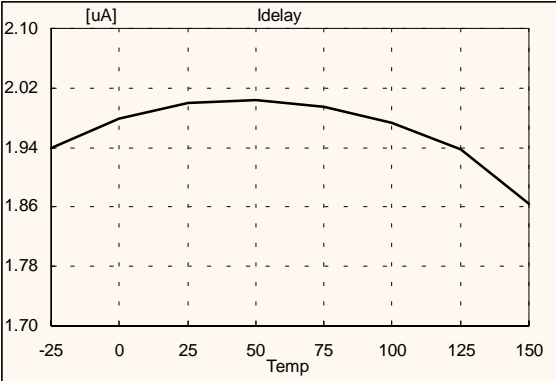

Figure 9. Shutdown Delay Current vs. Temp.

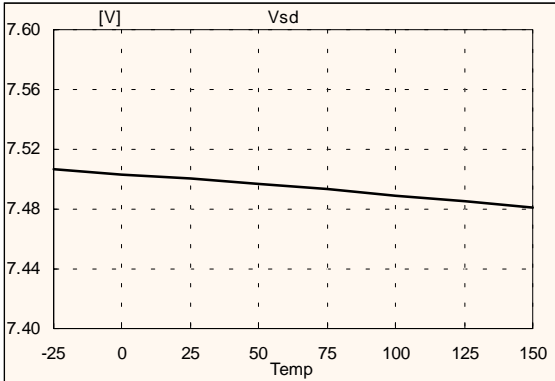

Figure 10. Shutdown Feedback Voltage vs. Temp.

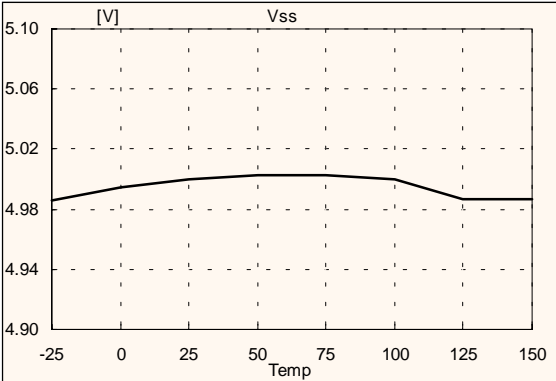

Figure 11. Softstart Voltage vs. Temp.

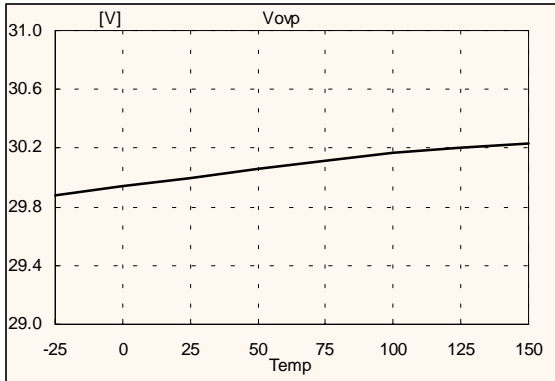

Figure 12. Over Voltage Protection vs. Temp.

Typical Performance Characteristics (Continued)

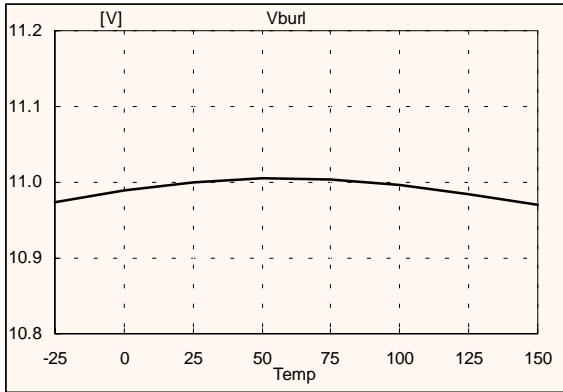

Figure 13. Burst Mode Low Voltage vs. Temp.

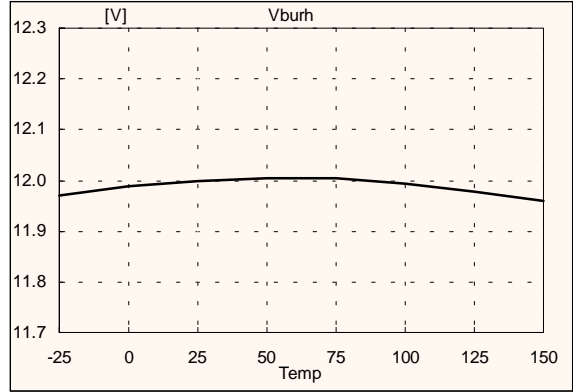

Figure 14. Burst Mode High Voltage vs. Temp.

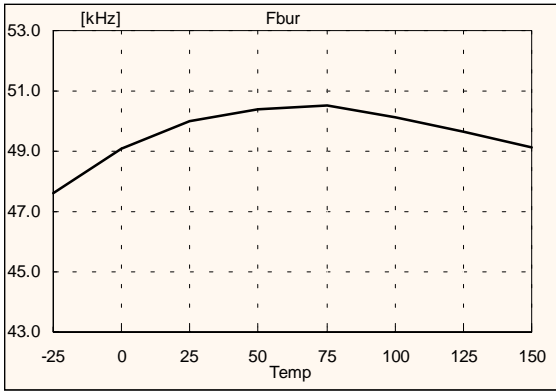

Figure 15. Burst Mode Frequency vs. Temp.

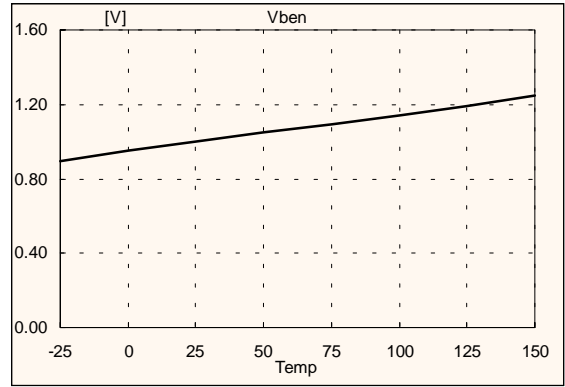

Figure 16. Burst Mode Enable Voltage vs. Temp.

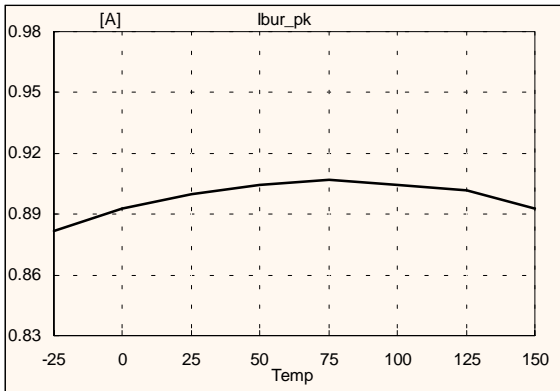

Figure 17. Burst Mode Peak Current vs. Temp.

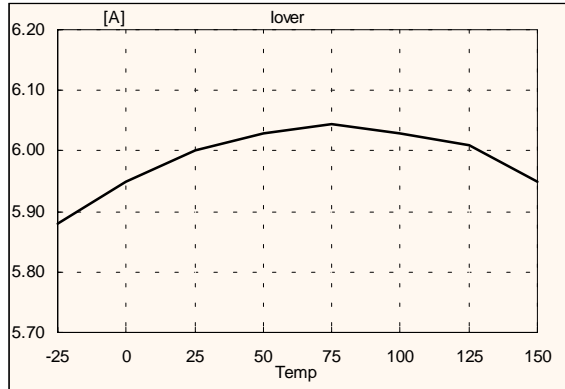
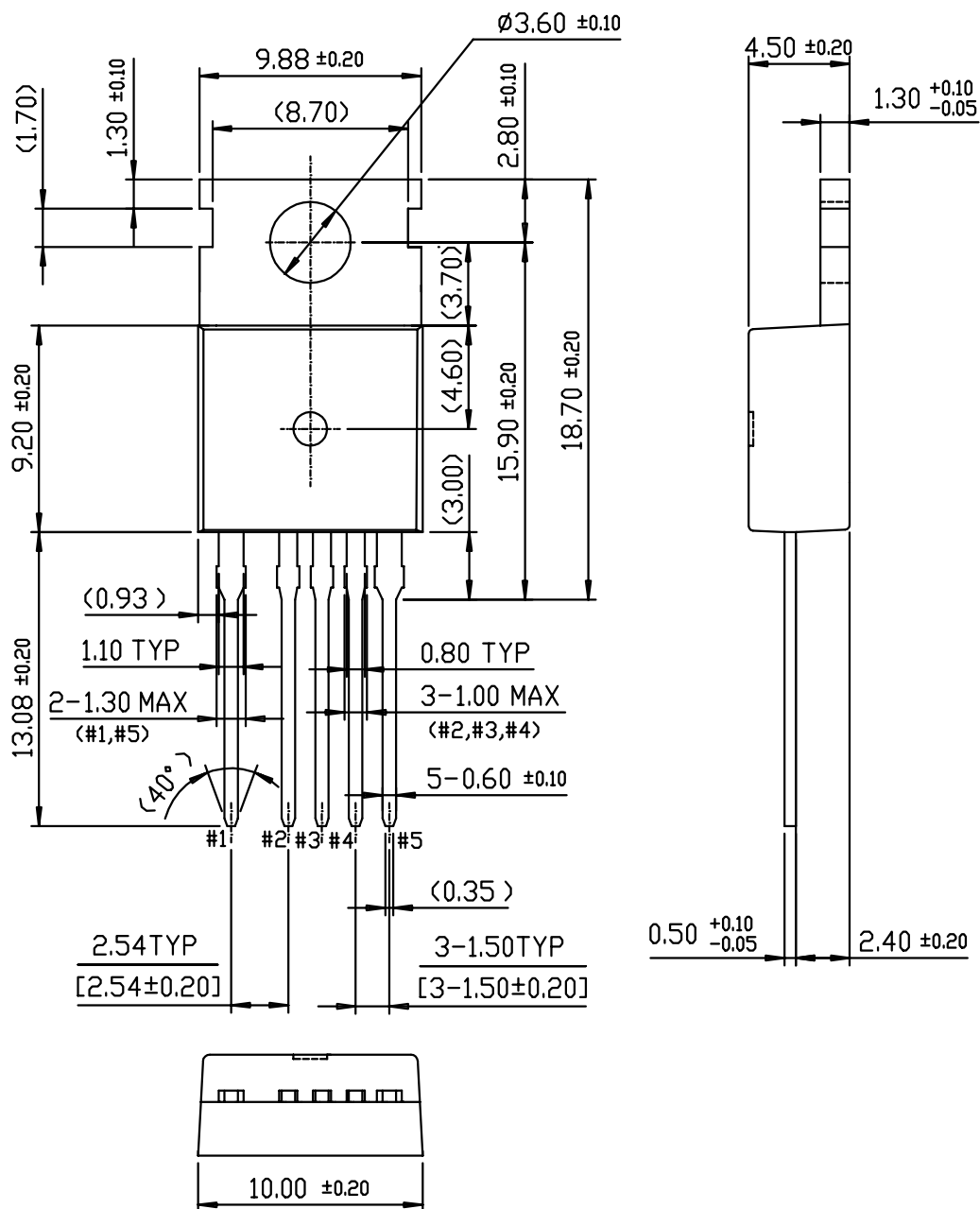

Figure 18. Peak Current Limit vs. Temp.

Package Dimensions

TO-220-5L



Package Dimensions (Continued)

TO-220-5L(Forming)

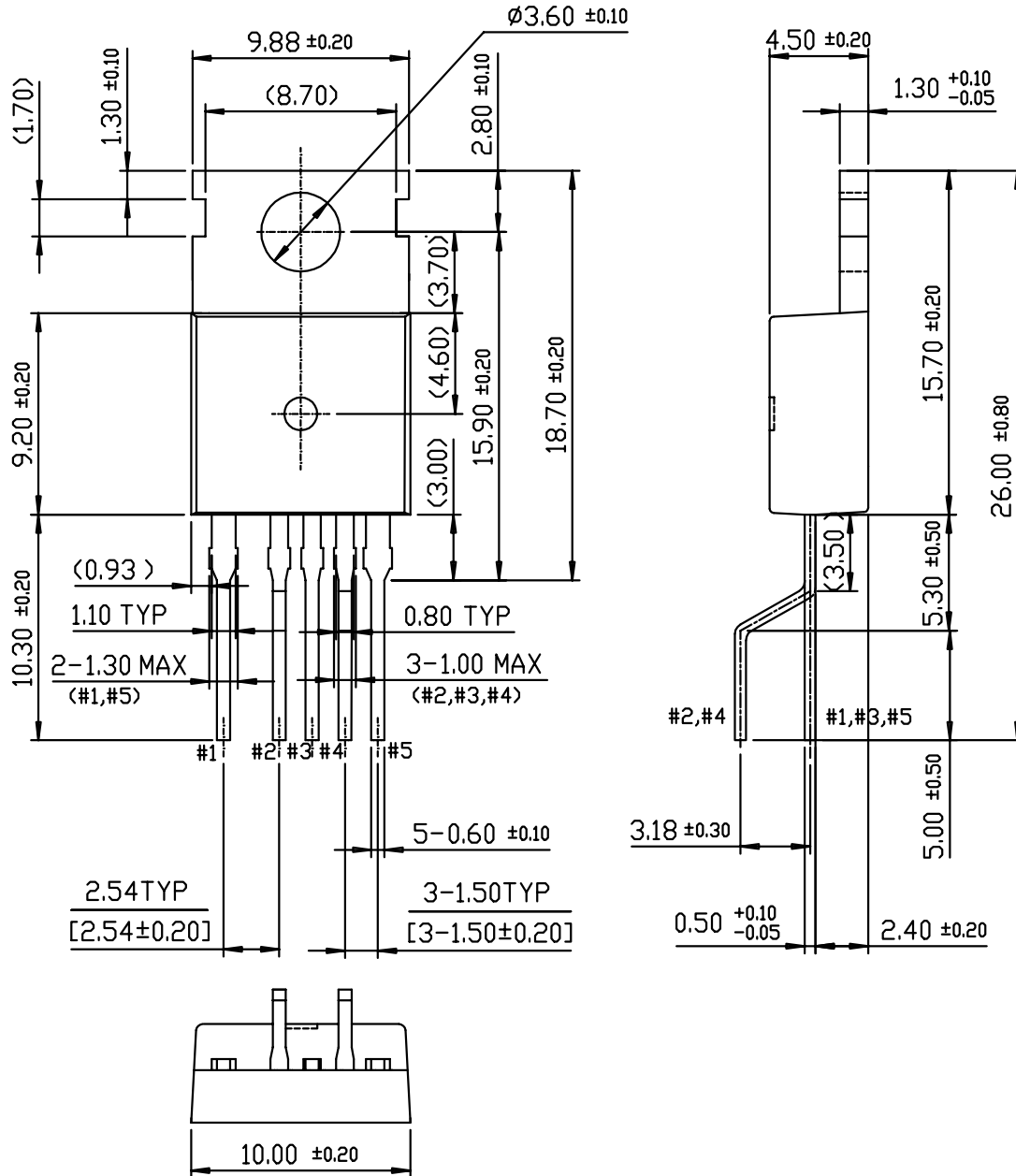

Ordering Information

Product Number	Package	Marking Code	BVdss	Rds(on)
FS6S0965RC-TU	TO-220-5L	6S0965RC	650V	1.0
FS6S0965RC-YDTU	TO-220-5L(Forming)			

TU : Non Forming Type

YDTU : Forming Type

DISCLAIMER

FAIRCHILD SEMICONDUCTOR RESERVES THE RIGHT TO MAKE CHANGES WITHOUT FURTHER NOTICE TO ANY PRODUCTS HEREIN TO IMPROVE RELIABILITY, FUNCTION OR DESIGN. FAIRCHILD DOES NOT ASSUME ANY LIABILITY ARISING OUT OF THE APPLICATION OR USE OF ANY PRODUCT OR CIRCUIT DESCRIBED HEREIN; NEITHER DOES IT CONVEY ANY LICENSE UNDER ITS PATENT RIGHTS, NOR THE RIGHTS OF OTHERS.

LIFE SUPPORT POLICY

FAIRCHILD'S PRODUCTS ARE NOT AUTHORIZED FOR USE AS CRITICAL COMPONENTS IN LIFE SUPPORT DEVICES OR SYSTEMS WITHOUT THE EXPRESS WRITTEN APPROVAL OF THE PRESIDENT OF FAIRCHILD SEMICONDUCTOR CORPORATION. As used herein:

1. Life support devices or systems are devices or systems which, (a) are intended for surgical implant into the body, or (b) support or sustain life, and (c) whose failure to perform when properly used in accordance with instructions for use provided in the labeling, can be reasonably expected to result in a significant injury of the user.
2. A critical component in any component of a life support device or system whose failure to perform can be reasonably expected to cause the failure of the life support device or system, or to affect its safety or effectiveness.