

MITSUBISHI ICs (TV)
M52346SP

SYNC SIGNAL PROCESSOR

DESCRIPTION

When a separate sync signal (polarity, positive and negative; $1 \sim 5V_{P-P}$), composite sync signal (polarity, positive and negative; $1 \sim 5V_{P-P}$), and sync ON video signal (polarity, negative) are input, M52346SP semiconductor integrated circuit automatically selects a suitable one, and shapes its waveform. This IC is optimal for automatic tracking type displays.

FEATURES

- Sync input on/off data and polarity data can be output.
- Pulse output pins are an open collector output type.
- Regarding clamp pulse output, the trigger of clamp pulses is generated at the latter edge of sync ON video signal input. The trigger is also generated at the latter edge of separate sync signal input or composite sync signal input.
- 20-pin shrink dual in-line package.

APPLICATION

Display monitors

RECOMMENDED OPERATING CONDITION

Supply voltage range..... $11 \sim 13V$
 Rated supply voltage..... $12V$

PIN CONFIGURATION (TOP VIEW)

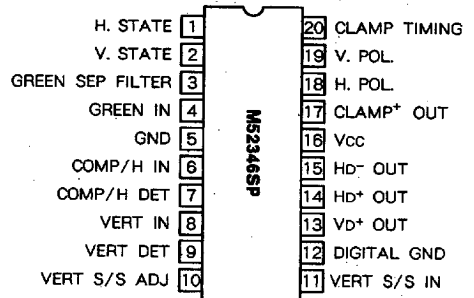

Outline 20P4B

SPECIFICATIONS

- When a sync ON video signal is input: Sync $\geq 0.2V_{P-P}$ (polarity: negative)
- When a composite sync signal or separate sync signal is input: $1 \sim 5V_{P-P}$ (Polarity: positive and negative)
- $f_H \leq 200kHz$
- Pulse output is an open collector type. Logical output is a TTL type.

BLOCK DIAGRAM

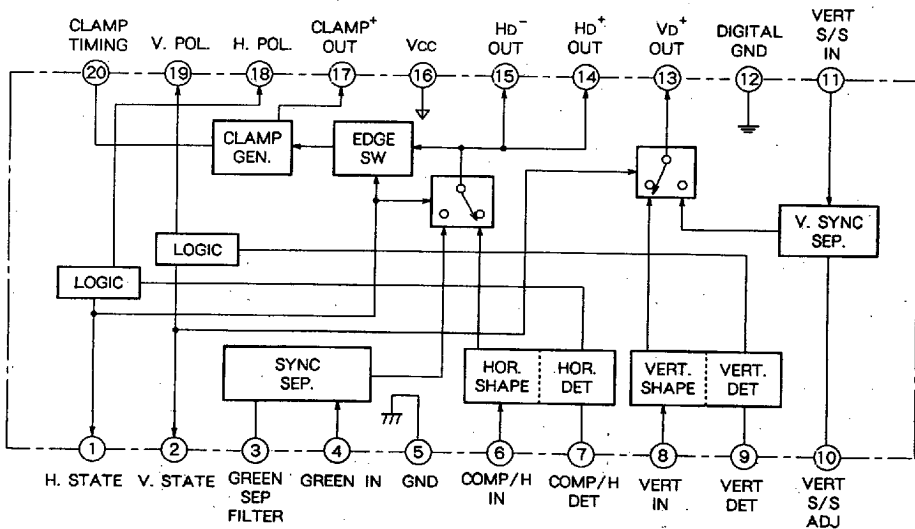

M52346SP

SYNC SIGNAL PROCESSOR

ABSOLUTE MAXIMUM RATINGS (Ta = 25 °C, unless otherwise noted)

Symbol	Parameter	Ratings	Unit
V _{cc}	Supply voltage	14.0	V
P _d	Power dissipation	1000	mW
T _{opr}	Operating temperature	-20~+85	°C
T _{stg}	Storage temperature	-40~+150	°C

















ELECTRICAL CHARACTERISTICS (Ta = 25 °C, V_{cc} = 12V, V_{DD} = 12V, unless otherwise noted)

Symbol	Parameter	Test conditions						Limits			Unit	Remarks		
		Switching conditions				Input pin	Input conditions	Output pin	Output waveform	Min.			Typ.	Max.
		4	6	8	16									
I _{cc}	Circuit current	2	2	2	2	16		A		25	35	45	mA	No input to pins ④, ⑥ and ⑧. Grounded to GND with capacitance V _{DD} is open.
10H	Pin ① output "High" level	2	1	1	1		6 7.5µs 16kHz 1V _{P-P}	1	DC	4.0	5.0	5.3	V	
							8 7.5µs 16kHz 1V _{P-P}							
10L	Pin ① output "Low" level	2	1	1	1		6 7.5µs 16kHz 0.7V _{P-P}	1	DC	-	-	0.5	V	Input signal 0.7V _{P-P} is equivalent to NO SYNC
							8 7.5µs 16kHz 0.7V _{P-P}							
20H	Pin ② output "High" level	2	1	1	1		6 7.5µs 16kHz 1V _{P-P}	2	DC	4.0	5.0	5.3	V	
							8 7.5µs 16kHz 1V _{P-P}							
20L	Pin ② output "Low" level	2	1	1	1		6 7.5µs 16kHz 0.7V _{P-P}	2	DC	-	-	0.5	V	Input signal 0.7V _{P-P} is equivalent to NO SYNC
							8 7.5µs 16kHz 0.7V _{P-P}							
180H	Pin ⑧ output "High" level	2	1	1	1		6 7.5µs 16kHz 1V _{P-P}	18	DC	4.0	5.0	5.3	V	
							8 7.5µs 16kHz 1V _{P-P}							

Refer to table 1 for truth values



ELECTRICAL CHARACTERISTICS (Cont.)

Symbol	Parameter	Test conditions						Limits			Unit	Remarks			
		Switching conditions				Input pin	Input conditions	Output pin	Output waveform	Min.			Typ.	Max.	
		4	6	8	16										
180L	Pin ⑩ output "Low" level	2	1	1	1	6	 7.5µs 16kHz 1V _{P-P}	18	DC	-	-	0.5	V	Refer to table 1 for truth values	
							8								 7.5µs 16kHz 1V _{P-P}
190H	Pin ⑩ output "High" level	2	1	1	1	6	 7.5µs 16kHz 1V _{P-P}	19	DC	4.0	5.0	5.3	V		
							8								 7.5µs 16kHz 1V _{P-P}
190L	Pin ⑩ output "Low" level	2	1	1	1	6	 7.5µs 16kHz 1V _{P-P}	19	DC	-	-	0.5	V		
							8								 7.5µs 16kHz 1V _{P-P}
V ₁₀	Threshold voltage	2	2	2	1			10	DC	0.7	1.0	1.4	V		
SS - NV	Sync-Sep Sync input signal maximum noise amplitude voltage	1	2	2	1	4	 1.5µs 16kHz 0.1V _{P-P}	14	There should be no pulse output	-	-	0.1	V		Input signal of 0.1V _{P-P} is dummy noise signal.
SS - LV	Sync-Sep Sync input signal minimum amplitude voltage	1	2	2	1	4	 1.5µs 16kHz 0.2V _{P-P}	14	 16kHz There should be no pulse output during this period	0.2	-	-	V		Check that there is no malfunction due to noise
150L	Pin ⑮ HD ⁻ output "Low" level	2	1	2	1	6	 7.5µs 16kHz 1V _{P-P}	15	V Meas	-	-	0.5	V		
140L	Pin ⑭ HD ⁺ output "Low" level	2	1	2	1	6	 7.5µs 16kHz 1V _{P-P}	14	V Meas	-	-	0.5	V		
170L	Pin ⑰ CP ⁺ output "Low" level	2	1	2	1	6	 7.5µs 16kHz 1V _{P-P}	17	V Meas	-	-	0.5	V		
130L	Pin ③ VD ⁺ output "Low" level	2	2	1	1	8	 7.5µs 16kHz 1V _{P-P}	13	V Meas	-	-	0.5	V		

ELECTRICAL CHARACTERISTICS (Cont.)

Symbol	Parameter	Test conditions						Limits			Unit	Remarks		
		Switching conditions				Input pin	Input conditions	Output pin	Output waveform	Min.			Typ.	Max.
		4	6	8	16									
HD ⁻ -DA	HD ⁻ - Delay time (A)	2	1	2	1	6	7.5μs 16kHz 1V _{P-P}	15		-	120	350	ns	
HD ⁻ -DB	HD ⁻ - Delay time (B)	2	1	2	1	6	7.5μs 16kHz 1V _{P-P}	15		-	150	350	ns	
HD ⁺ -DA	HD ⁺ - Delay time (A)	2	1	2	1	6	7.5μs 16kHz 1V _{P-P}	14		-	120	350	ns	
HD ⁺ -DB	HD ⁺ - Delay time (B)	2	1	2	1	6	7.5μs 16kHz 1V _{P-P}	14		-	100	350	ns	
CP ⁺ -DT	CP ⁺ - Delay time	2	1	2	1	6	7.5μs 16kHz 1V _{P-P}	17		-	180	350	ns	
CP ⁺ -PW	CP ⁺ -PULSE - WIDTH	2	1	2	1	6	7.5μs 16kHz 1V _{P-P}	17		450	700	850	ns	
VD ⁺ -DA	VD ⁺ - Delay time (A)	2	2	1	1	8	7.5μs 16kHz 1V _{P-P}	13		-	120	350	ns	
VD ⁺ -DB	VD ⁺ - Delay time (B)	2	2	1	1	8	7.5μs 16kHz 1V _{P-P}	13		-	100	350	ns	

TYPICAL CHARACTERISTICS

**THERMAL DERATING
(MAXIMUM RATING)**

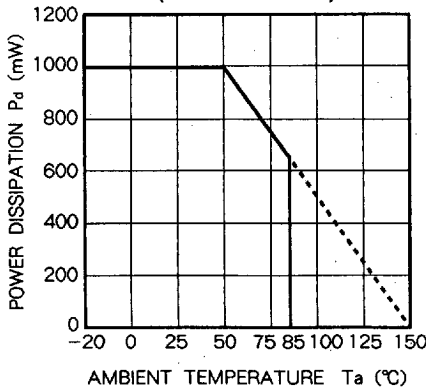

TEST CIRCUIT

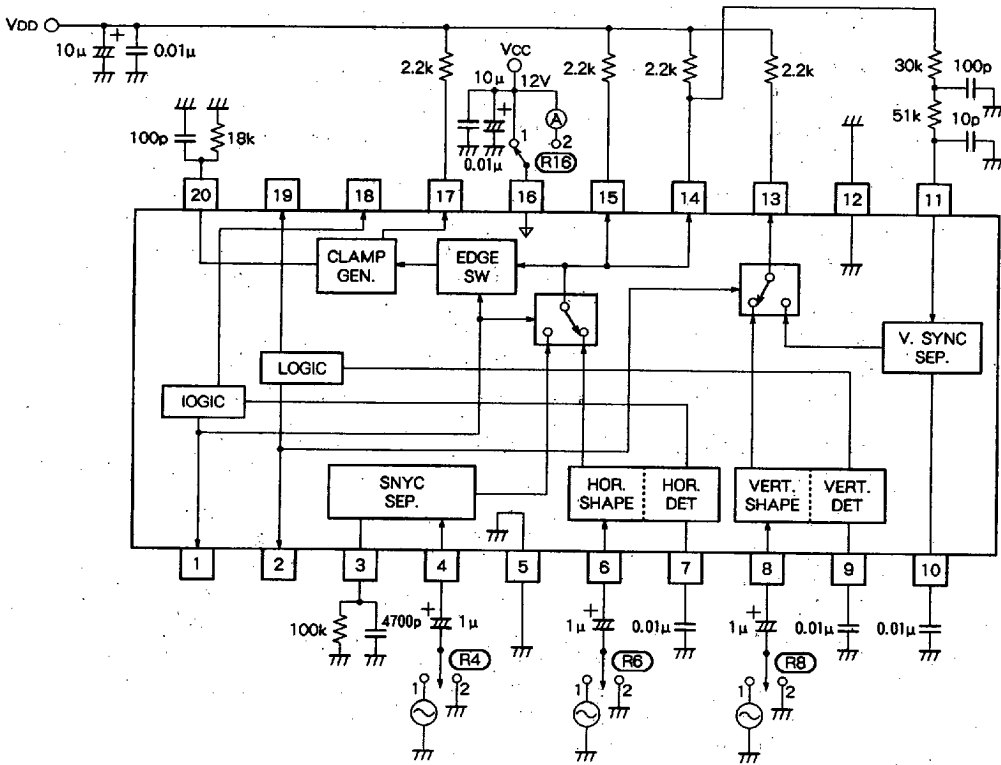

Units Resistance : Ω
Capacitance : F

Table1. Decoder logic output

Pin ① input HD. COMP.	Pin ② input VD	Output pin			
		①	②	⑬	⑭
HD. COMP.(POS.)	NON	H	L	L	L
HD. COMP.(POS.)	VD (POS.)	H	H	L	L
HD. COMP.(POS.)	VD (NEG.)	H	H	L	H
HD. COMP.(NEG.)	NON	H	L	H	L
HD. COMP.(NEG.)	VD (POS.)	H	H	H	L
HD. COMP.(NEG.)	VD (NEG.)	H	H	H	H
NON	NON	L	L	L	L
NON	VD (POS.)	L	H	L	L
NON	VD (NEG.)	L	H	L	H

Table2. Allowable input amplitude voltage

Pin ④ input amplitude		Vv 0~2.1 (VP-P) Vs 0.2~0.6 (VP-P)
Pin ⑥ input amplitude		Vs 1.0~5.0 (VP-P)
Pin ⑧ input amplitude		Vs 1.0~5.0 (VP-P)

Table3. The order of priority in output

Input signal (pin)			Output signal (pin)		
Pin ④	Pin ⑥	Pin ⑧	Pin ④ and ⑤	Pin ③	Pin ⑦
○	x	x	4	11	4
○	○	x	6	11	6
○	x	○	4	8	4
○	○	○	6	8	6
x	x	x	x	x	x
x	○	x	6	11	6
x	x	○	x	8	x
x	○	○	6	8	6

Table4. Maximum allowable input signal pulse duty ratio

Pin ⑥ input pulse (HD. COMP.)

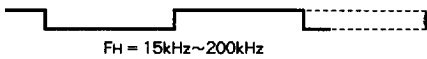
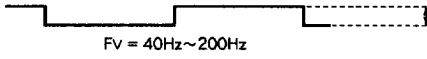
FH = 16kHz

Maximum amplitude voltage (VP-P)	1.0	3.3	4.0	5.0
POS. %	15.0	13.8	11.2	9.0
Time (μs)	9.38	8.63	7.00	5.63
NEG. %	15.0	13.0	10.5	8.8
Time (μs)	9.38	8.13	6.56	5.50

Pin ⑧ input pulse (VD)

FV = 60Hz

Maximum amplitude voltage (VP-P)	1.0	3.3	4.5	5.0
POS. %	14.1	12.1	9.8	7.7
Time (ms)	2.35	2.02	1.63	1.28
NEG. %	14.8	11.3	9.2	7.5
Time (ms)	2.47	1.88	1.53	1.25

APPLICATION METHOD

1. Input section

1) Green (Sync ON Video) input (pin ③ and ④)

Sync ON Video signals are input in negative polarity. For sync separation, the sync chip is clamped with an external capacitor connected to pin ④ as well as capacitance and resistance connected to pin ③. The pin ④ sync chip is approximately 4V. Threshold voltage is set to a level that is approximately +0.1V less than the sync chip.

2) Input of composite sync, H sync, and V sync signals composite sync input is connected to pin ⑥. For separate sync input, H is connected to pin ⑥ and V is connected to pin ⑧. The bias of pin ⑥ and pin ⑧ is 6V, and the impedance is 10kΩ. Waveform shaping and polarity detection are conducted by a built-in double threshold converter.

The internal circuit is connected as shown in Fig. 2. The average DC voltage of input signals is called V₂. Threshold voltages are adjusted to V₂ ± 0.7V.

Therefore, when the duty ratio is small as shown in Fig. 1, this IC works with an amplitude of approximately 0.7VP-P or more. When the duty ratio is large, the optimal amplitude is approximately 1.4VP-P. Fig. 3 shows allowable input duty reference measured values.

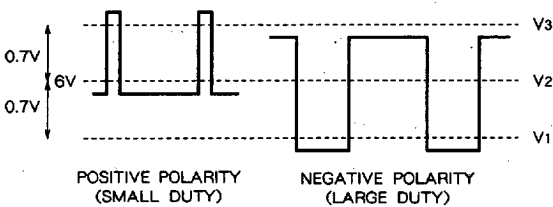

Fig. 1

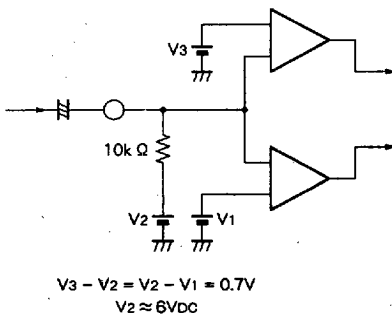

Fig. 2

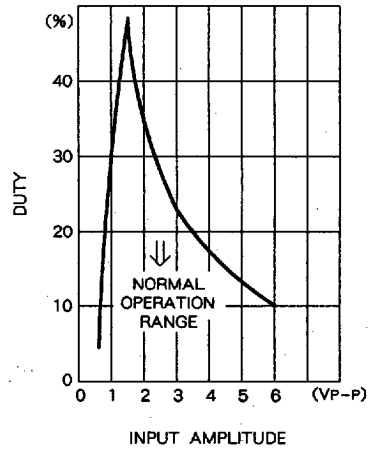

Fig. 3

Fig. 4 shows an application example in which the allowable duty ratio characteristic can be improved when input amplitude is 1.4VP-P or more.

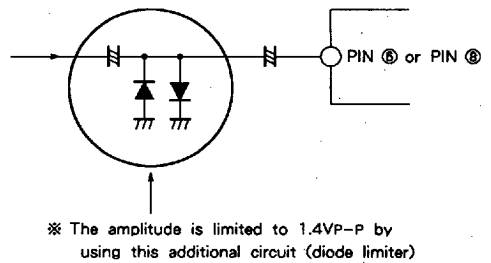

Fig. 4

When the IC is used at voltage outside the rated range, remove filters from pins ⑦ and ⑨, and check the waveform to ensure that it is as shown in Fig. 5.

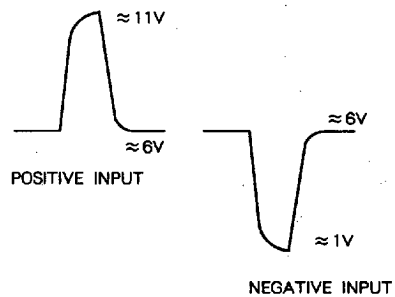

Fig. 5

3) Polarity detection and no-input detection (pins ⑦ and ⑨)

External capacitance is necessary as a filter to detect polarity and "no-input." The larger the capacitance, the smaller the ripple, diminishing malfunction probability. However, when large capacitance is provided, the response slows down. Capacitance should be at least 0.05 μ F when input is 15kHz. It should be at least 10 μ F when input is 60Hz. For operation with lower capacitance, check the filter pin waveform under conditions where input sync signal frequency and duty ratio are set to a minimum, and check that voltage is 7.5V or more (6.6V actually) when input is positive, and that voltage is 4.5V or less (5.5V actually) when input is negative.

4) VERT S/S IN (pin ⑪)

For V sync separation, signals are generated by externally integrating composite sync signals, and are then input.

The composite sync signals that are input to pin ⑥ (H + V) are output to pin ⑭ HD*. For V sync separation, pin ⑭ HD* output is externally integrated, and is input to pin ⑪. Check pin ⑪ waveform to see if the H element is adequately low.

In the IC, the sync separation threshold level is set to approximately 1V when no external adjustment is provided.

5) VERT S/S ADJ (pin ⑩)

The threshold voltage is approximately 1V when no external adjustment is provided. The threshold voltage is dependent on IC internal resistance. Pin ⑩ may be open; however, if noise may give adverse effect, ground the pin with capacitor.

When the H element cannot be lowered sufficiently, connect resistance between pin ⑩ and Vcc to change the threshold level. (Provide resistance such that when VDD(Digital Vcc) is 12V, the threshold voltage will be 8V or less; and when VDD is 5V, the threshold voltage will be 4V or less.)

When there are serration pulses or other pulses during the V period, provide resistance such that the threshold voltage will be half as high as VDD.

2. CP-Width

Timing pin (pin ⑫)

The time constant is determined depending on the current that flows out of pin ⑫ and timing pin capacitance. The current is normally determined depending on pin voltage and external resistance. When external resistance is 18k Ω (namely 200 μ A) and timing pin external capacitance is 100pF, the pulse width is 0.7 μ sec.

3. Output stage

1) Logic output (pins ①, ②, ⑬ and ⑮)

The output type is as shown below. IC internal load resistance is 20k Ω .

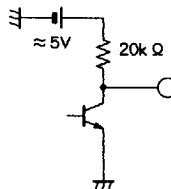

2) Pulse output (pins ⑬, ⑭, ⑮ and ⑰)

The pins are the open collector type as shown below. Current of approximately 6mA can be applied.



3) Power supply

Supply 12V to pin ⑯.

Supply digital Vcc = 5~12V as power supply for pulse output.

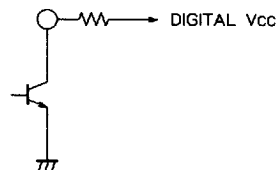

4. Other

Differences between M52036SP and M52346SP

The clamp pulse trigger is different between M52036SP and M52346SP when "S on G" and "H/H + V" are input simultaneously, or when only "H/H + V" is input.

- M52036SP.....Generated at the first edge of "H/H + V" input.
- M52346SP.....Generated at the latter edge of "H/H + V" input.

M52346SP clamp pulses are generated at the latter edge of signals that have been given priority.

We believe this arrangement makes this IC more useful with MAC signals.

The M52346SP pin configuration is the same as that of M52036SP.

RECOMMENDED CIRCUIT (f_H = 15kHz, f_V = 60Hz)

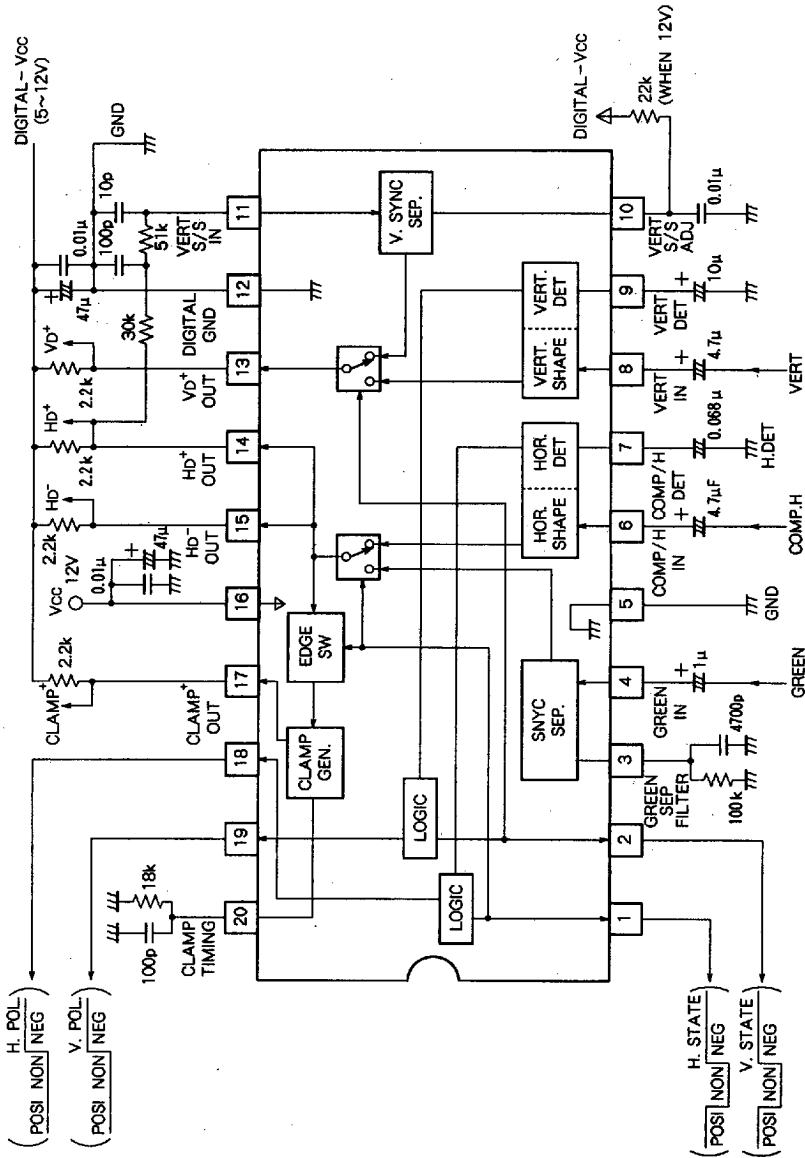

Units Resistance : Ω
Capacitance : F

DESCRIPTION OF PIN

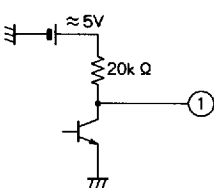
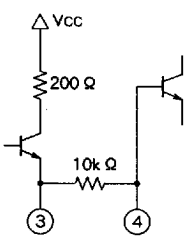
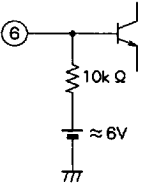
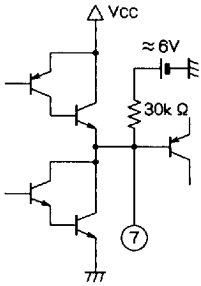
Pin no.	Name	Pin voltage	Equivalent circuit	Description of pin
①	H. STATE	0Vdc or 5Vdc		Horizontal sync signal logic output pin. Outputs "H" when pin ⑥ input signal is positive; outputs "L" when there is no input; and outputs "H" when pin ⑥ input signal is negative.
②	V. STATE	0Vdc or 5Vdc	The same as pin ①	Vertical sync signal logic output pin. Outputs "H" when pin ⑥ input signal is positive; outputs "L" when there is no input; and outputs "H" when pin ⑥ input signal is negative.
③	GREEN SEP FILTER	When open ≈ 4V		GREEN (Video) SEP FILTER pin. Biases itself according to external capacitance (C) and resistance (R) time constant. Resistance (R) is a discharging type, and is provided to enhance self-biasing circuit responding characteristics. The smaller the resistance, the smaller the self-biasing circuit gain.
④	GREEN IN	When open ≈ 4V		GREEN (Sync on Video) input pin. C-connected, and inputs Green (Sync on Video) signal. Sync is negative.
⑤	GND	—	—	Grounding
⑥	COMP/H IN	When open ≈ 6V		Composite sync/H sync input pin. Bias is approximately 6V, and impedance is 10kΩ. Waveform shaping and polarity detection are conducted by built-in double threshold comparator. The optimal input amplitude is approximately 1.5VP-P. The waveform shaping and polarity detection are possible when the duty is approximately 50% or less.
⑦	COMP/H DET	When open ≈ 6V (No signal)		External capacitance is required as filter pin for polarity detection and no-input detection. The larger the capacitance, the smaller the ripple, reducing malfunction probability. However, detection response becomes slow.
⑧	VERT IN	When open ≈ 6V	The same as pin ⑥	V sync input pin The same as pin ⑥
⑨	VERT DET	When open ≈ 6V (No signal)	The same as pin ⑦	The same as pin ⑦

DESCRIPTION OF PIN (Cont.)

Pin no.	Name	Pin voltage	Equivalent circuit	Description of pin
⑩	VERT S/S ADJ	When open ≈ 1V		VERT S/S ADJ pin When no external adjustment is conducted, threshold voltage is approximately 1V.
⑪	VERT S/S IN	—		VERT S/S IN pin Signals that are obtained by externally integrating composite sync signals for V sync separation are input.
⑫	DIGITAL GND	—	—	Grounding
⑬	VD ⁺ OUT	—		VD ⁺ Pulse output pin Open collector output type. Output amplitude is variable. Able to accommodate 6mA currents.
⑭	HD ⁺ OUT	—	The same as pin ⑬	HD ⁺ Pulse output pin The same as pin ⑬
⑮	HD ⁻ OUT	—	The same as pin ⑬	HD ⁻ Pulse output pin The same as pin ⑬
⑯	Vcc	12V	—	Power source
⑰	CLAMP ⁺ OUT	—	The same as pin ⑬	Clamp ⁺ Pulse output pin The same as pin ⑬
⑱	H. POL.	0Vdc or 5Vdc	The same as pin ①	Horizontal sync signal logic output pin. Outputs "L" when pin ⑥ input signal is positive or when there is no input to pin ⑥. Outputs "H" when pin ⑥ input signal is negative.
⑲	V. POL.	0Vdc or 5Vdc	The same as pin ①	Horizontal sync signal logic output pin. Outputs "L" when pin ⑥ input signal is positive or when there is no input to pin ⑥. Outputs "H" when pin ⑥ input signal.
⑳	CLAMP TIMING			Clamp timing pin. Clamp pulse amplitude is determined depending on external capacitance (C) and resistance (R). The larger the C and R, the larger clamp pulse width.