

Dual preamplifier with mute function

BA3406AF

The BA3406AF is a multi-function dual-channel preamplifier with a built-in mute circuit and a time-constant switching circuit for use with metal tape. The output circuits have diodes, and can be connected to other circuits in parallel, which eliminates the need for switches. The mute circuit is independent of the preamplifier block, and can be used to mute the whole system.

● Applications

Car stereos, radio cassette players, and tape decks

● Features

- 1) Wide operating power supply voltage range (6V to 14V).
- 2) Low noise ($V_{NIN} = 1.0\mu V_{rms}$ Typ.).
- 3) High open loop voltage gain ($G_{VO} = 80dB$ Typ. at pins 1 and 15).
- 4) Two channels on one chip, providing good channel balance.
- 5) Emitter-follower outputs for low output impedance.
- 6) Built-in switching circuit for use with metal tape.
- 7) Built-in mute circuit.
- 8) Mute and metal-tape circuits are independent from the preamplifier circuit to allow greater design freedom.
- 9) The output circuits have diodes to prevent current backflow and enable parallel connection to other circuits.
- 10) The resistor for the CR circuit that sets the metal-tape circuit time constant to $70\mu s$ is on the chip. Setting the time constant only requires addition of an external capacitor.

● Block diagram

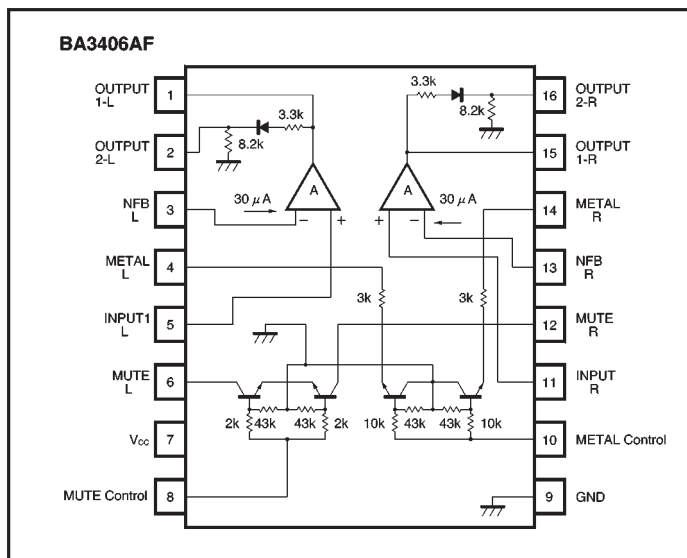

● Internal circuit configuration

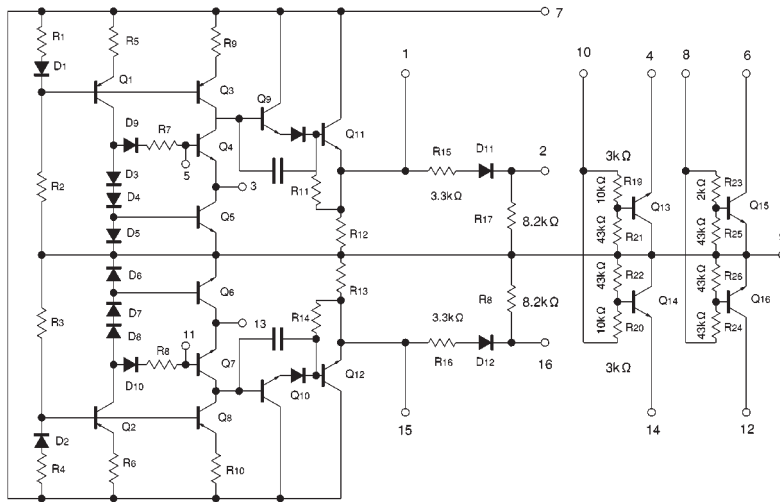

● Absolute maximum ratings (Ta = 25°C)

Parameter	Symbol	Limits	Unit
Power supply voltage	V _{CC}	16	V
Power dissipation	P _d	500*	mW
Operating temperature	T _{opr}	-25~+75	°C
Storage temperature	T _{stg}	-55~+125	°C

* Reduced by 5.0mW for each increase in Ta of 1°C over 25°C.

● Recommended operating conditions (Ta = 25°C)

Parameter	Symbol	Min.	Typ.	Max.	Unit
Power supply voltage	V _{CC}	6	8	14	V

● Electrical characteristics (unless otherwise noted, Ta = 25°C and V_{CC} = 8V)

Parameter	Symbol	Min.	Typ.	Max.	Unit	Conditions
Quiescent current	I _Q	—	3.0	4.5	mA	V _{IN} =0V _{rms}
Open loop voltage gain (pins 1 and 15)	G _{vo}	75	80	—	dB	V _{OUT} =0.3V _{rms} , f=1kHz
Input conversion-noise voltage	V _{NIN}	—	1.0	2.0	μV _{rms}	V _{IN} =0V _{rms} , R _g =2.2kΩ
Maximum output voltage (pins 1 and 15)	V _{OM}	1.0	1.4	—	V _{rms}	THD=1%, f=1kHz
Interchannel crosstalk	CT	50	65	—	dB	f=1kHz, R _g =2.2kΩ
Total harmonic distortion (pins 1 and 15)	THD	—	0.1	0.6	%	V _{OUT} =0.3V _{rms}
Channel balance	CB	—	0	1.5	dB	V _{OUT} =0.3V _{rms}
Input resistance	R _{IN}	50	—	—	kΩ	—

●Electrical characteristics curves

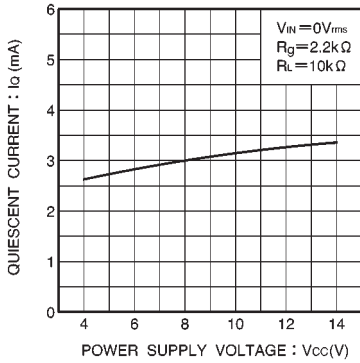

Fig. 3 Quiescent current vs. power supply voltage

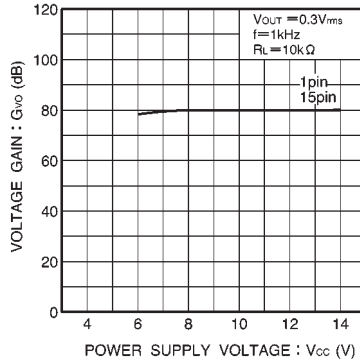

Fig. 4 Voltage gain vs. power supply voltage

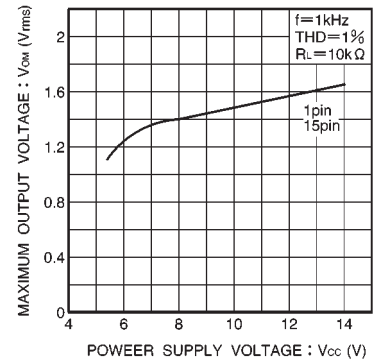

Fig. 5 Maximum output voltage vs. power supply voltage

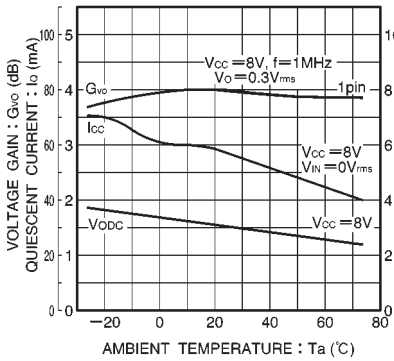

Fig. 6 Voltage gain, quiescent current and output voltage vs. ambient temperature

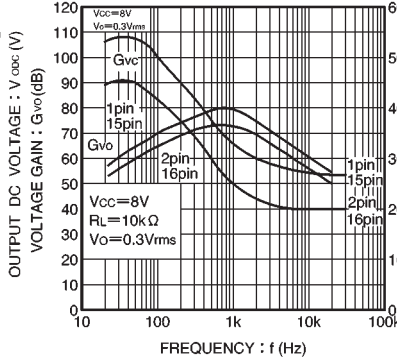

Fig. 7 Voltage gain vs. frequency

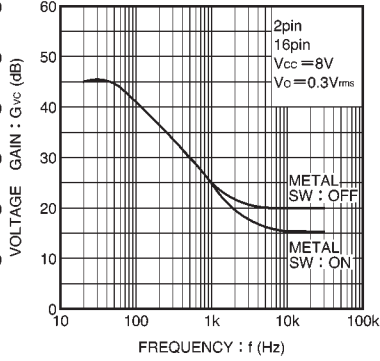

Fig. 8 Metal tape equalizer characteristics

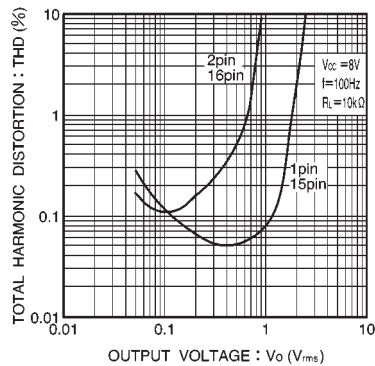

Fig. 9 Distortion vs. output voltage

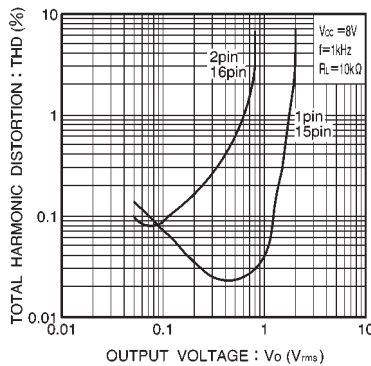

Fig. 10 Distortion vs. output voltage

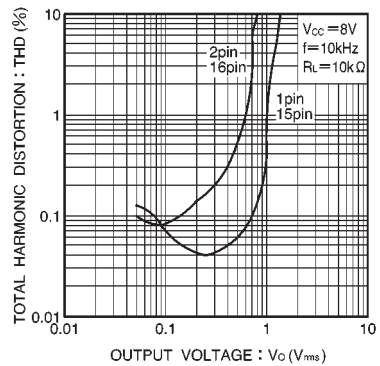

Fig. 11 Distortion vs. output voltage

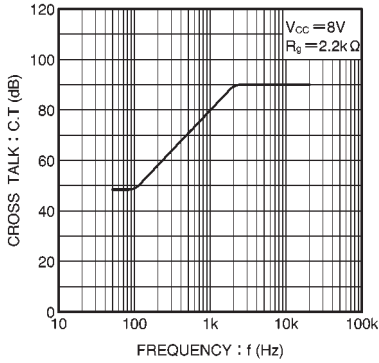

Fig. 12 Crosstalk

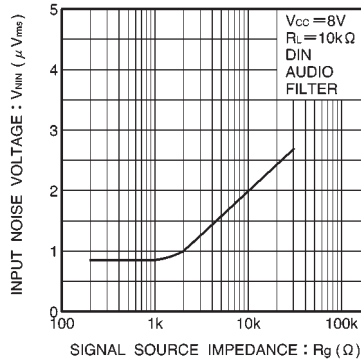

Fig. 13 Input conversion noise voltage vs. signal source resistance

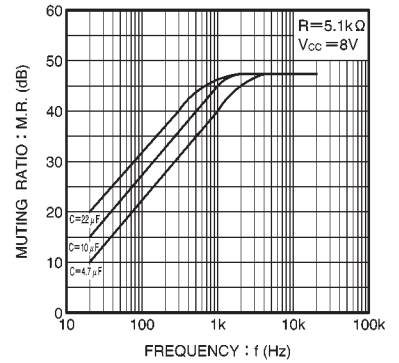

Fig. 14 Muting ratio vs. frequency

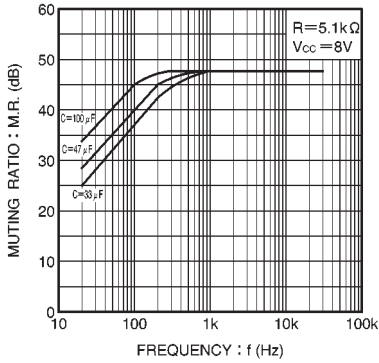

Fig. 15 Muting ratio vs. frequency

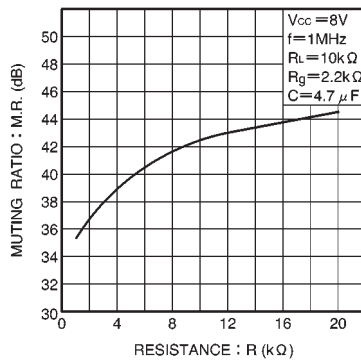

Fig. 16 Muting ratio vs. frequency

● External dimensions (Units: mm)

