

## Silicon N-Channel MOSFET Tetrode

- For low noise, high gain controlled input stages up to 1GHz
- Operating voltage 9 V
- Integrated stabilized bias network

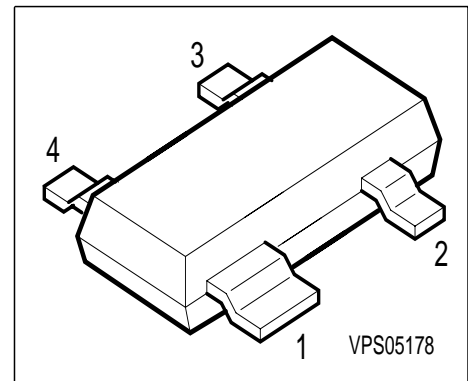
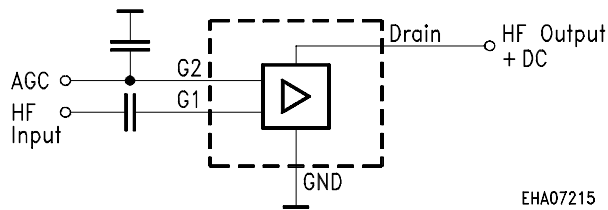

**ESD:** Electrostatic discharge sensitive device, observe handling precaution!

Type	Marking	Ordering Code	Pin Configuration				Package
BF 1009	JKs	Q62702-F1613	1 = S	2 = D	3 = G2	4 = G1	SOT-143

### Maximum Ratings

Parameter	Symbol	Value	Unit
Drain-source voltage	$V_{DS}$	12	V
Continuous drain current	$I_D$	25	mA
Gate 1/gate 2 peak source current	$\pm I_{G1/2SM}$	10	
Gate 1 (external biasing)	$+V_{G1SE}$	3	V
Total power dissipation, $T_S \leq 76 \text{ }^\circ\text{C}$	$P_{tot}$	200	mW
Storage temperature	$T_{stg}$	-55 ... +150	$^\circ\text{C}$
Channel temperature	$T_{ch}$	150	

### Thermal Resistance

Channel - soldering point	$R_{thchs}$	$\leq 370$	K/W
---------------------------	-------------	------------	-----

### Note:

It is not recommended to apply external DC-voltage on Gate 1 in active mode.

**Electrical Characteristics** at  $T_A = 25^\circ\text{C}$ , unless otherwise specified.

Parameter	Symbol	Values			Unit
		min.	typ.	max.	
<b>DC characteristics</b>					
Drain-source breakdown voltage $I_D = 300 \mu\text{A}$ , $-V_{G1S} = 4 \text{ V}$ , $-V_{G2S} = 4 \text{ V}$	$V_{(BR)DS}$	16	-	-	V
Gate 1 source breakdown voltage $\pm I_{G1S} = 10 \text{ mA}$ , $V_{G2S} = V_{DS} = 0$	$\pm V_{(BR)G1SS}$	8	-	12	
Gate 2 source breakdown voltage $\pm I_{G2S} = 10 \text{ mA}$ , $V_{G1S} = 0 \text{ V}$ , $V_{DS} = 0 \text{ V}$	$\pm V_{(BR)G2SS}$	9	-	16	
Gate 1 source current $V_{G1S} = 6 \text{ V}$ , $V_{G2S} = 0 \text{ V}$	$+I_{G1SS}$	-	-	60	$\mu\text{A}$
Gate 2 source leakage current $\pm V_{G2S} = 8 \text{ V}$ , $V_{G1S} = 0 \text{ V}$ , $V_{DS} = 0 \text{ V}$	$\pm I_{G2SS}$	-	-	50	nA
Drain current $V_{DS} = 9 \text{ V}$ , $V_{G1S} = 0$ , $V_{G2S} = 6 \text{ V}$	$I_{DSS}$	-	-	500	$\mu\text{A}$
Operating current (selfbiased) $V_{DS} = 9 \text{ V}$ , $V_{G2S} = 6 \text{ V}$	$I_{DSO}$	8	10	-	mA
Gate 2-source pinch-off voltage $V_{DS} = 9 \text{ V}$ , $I_D = 100 \mu\text{A}$	$V_{G2S(p)}$	-	0.9	-	V
<b>AC characteristics</b>					
Forward transconductance (self biased) $V_{DS} = 9 \text{ V}$ , $V_{G2S} = 6 \text{ V}$ , $f = 1 \text{ kHz}$	$g_{fs}$	-	24	-	mS
Gate 1-input capacitance (self biased) $V_{DS} = 9 \text{ V}$ , $V_{G2S} = 6$ , $f = 1 \text{ MHz}$	$C_{g1ss}$	-	2.1	2.5	pF
Output capacitance (self biased) $V_{DS} = 9 \text{ V}$ , $V_{G2S} = 6$ , $f = 100 \text{ MHz}$	$C_{dss}$	-	0.9	-	
Power gain (self biased) $V_{DS} = 9 \text{ V}$ , $V_{G2S} = 6$ , $f = 800 \text{ MHz}$	$G_{ps}$	-	22	-	dB
Noise figure (self biased) $V_{DS} = 9 \text{ V}$ , $V_{G2S} = 6$ , $f = 800 \text{ MHz}$	$F_{800}$	-	1.4	-	
Gain control range (self biased) $V_{DS} = 9 \text{ V}$ , $V_{G2S} = 1 \text{ V}$ , $f = 800 \text{ MHz}$	$\Delta G_{ps}$	40	50	-	

**Total power dissipation  $P_{\text{tot}} = f(T_S)$**

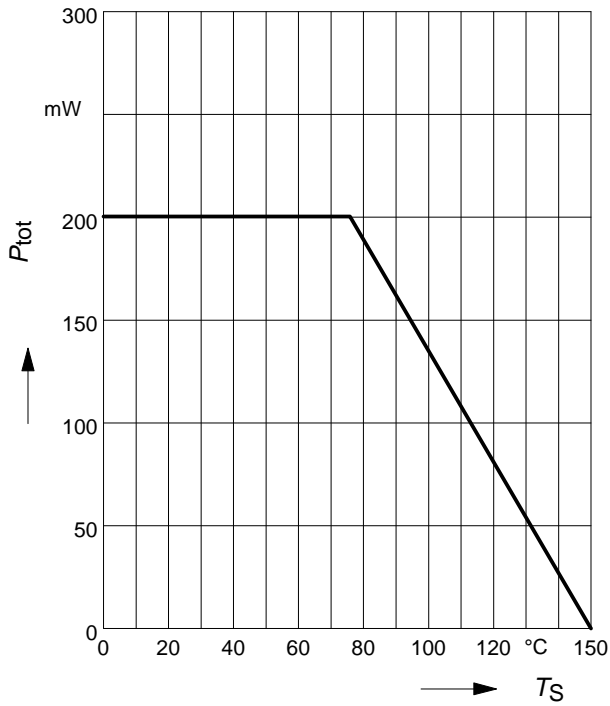

**Drain current  $I_D = f(V_{G2S})$**

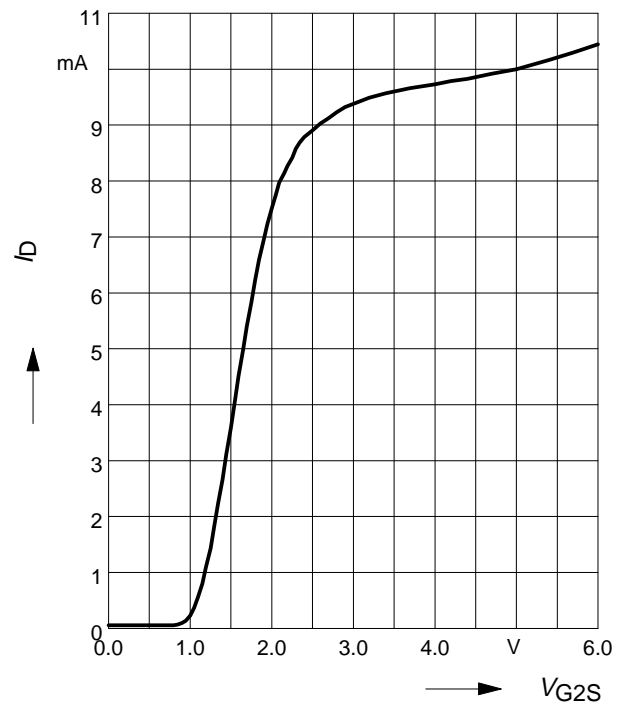

**Insertion power gain**

$|S_{21}|^2 = f(V_{G2S})$

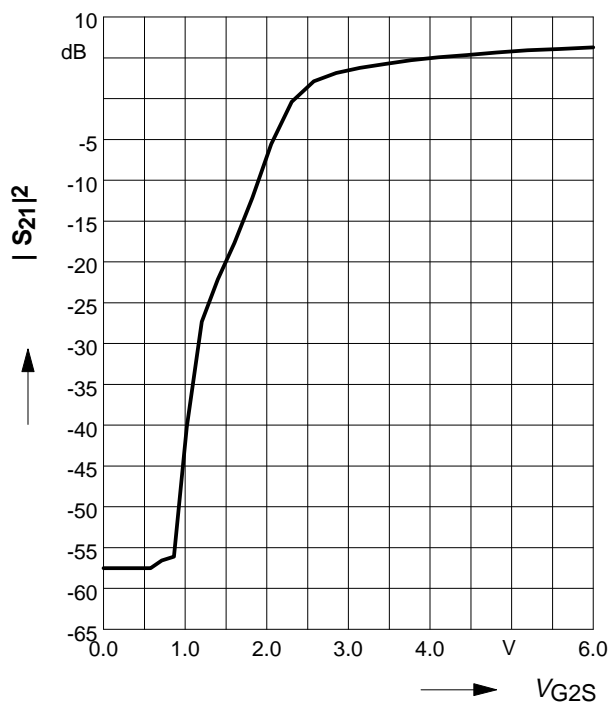

**Forward transfer admittance**

$|Y_{21}| = f(V_{G2S})$

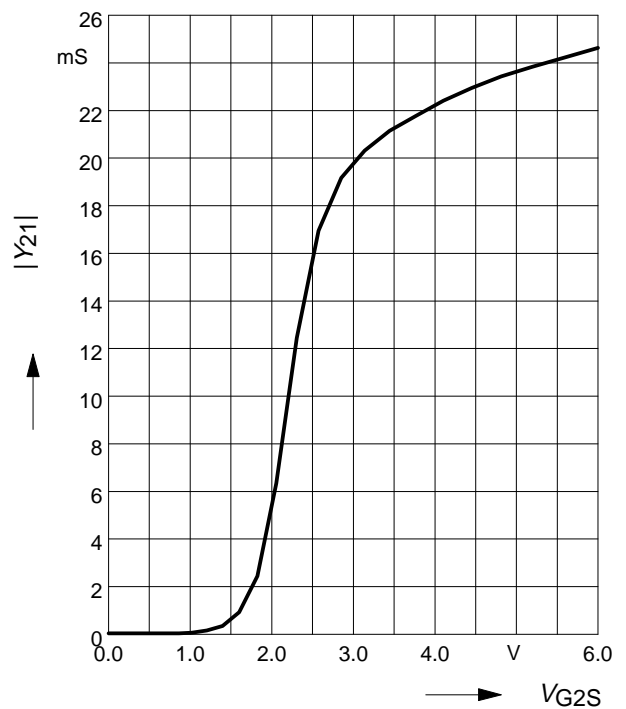

**Gate 1 input capacitance**  $C_{g1ss} = f(V_{g2s})$   
 $f = 200\text{MHz}$

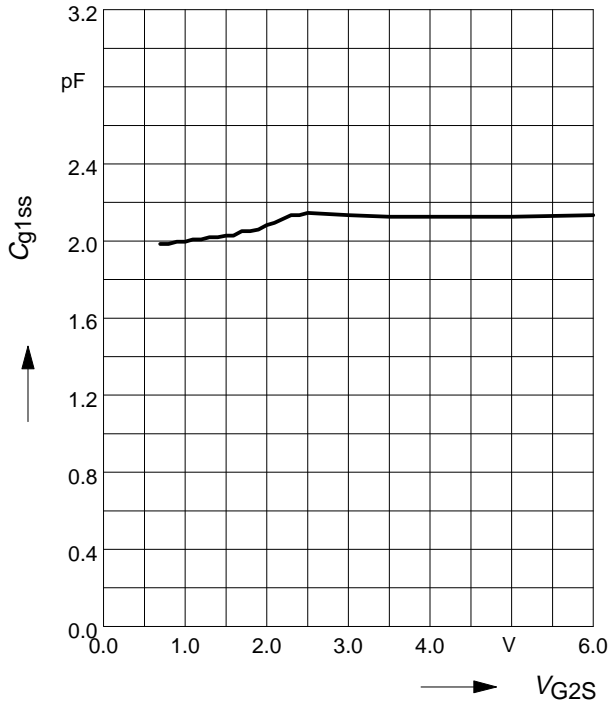

**Output capacitance**  $C_{dss} = f(V_{G2})$   
 $f = 200\text{MHz}$

