

FEATURES

- **Ultralow Quiescent Current: 8.5µA Max**
- Wide Supply Range
 - Single: 2V to 11V
 - Dual: ±1V to ±5.5V
- Input Voltage Range Includes the Negative Supply
- **Reference Output Drives 0.01µF Capacitor**
- **Adjustable Hysteresis (LTC1444/LTC1445)**
- TTL/CMOS Compatible Outputs
- Propagation Delay: 12µs (Typ) (10mV Overdrive)
- No Crowbar Current
- 40mA Continuous Source Current
- Pin Compatible Upgrades for MAX924 (LTC1443)

APPLICATIONS

- Battery-Powered System Monitoring
- Threshold Detectors
- Window Comparators
- Oscillator Circuits

DESCRIPTION

The LTC[®]1443/LTC1444/LTC1445 are ultralow power quad comparators with built-in reference. The comparators feature less than 8.5µA supply current over temperature, an internal reference (1.182V±1% for LTC1443 or 1.221V±1% for LTC1444/LTC1445), programmable hysteresis (LTC1444/LTC1445) and TTL/CMOS output (LTC1443/LTC1445) that sinks and sources current (open-drain output for LTC1444). The reference output can drive a bypass capacitor of up to 0.01µF without oscillation.

The comparators operate from a single 2V to 11V supply or a dual ±1V to ±5.5V supply (LTC1443). Comparator hysteresis is easily programmable using two resistors and the HYST pin (LTC1444/LTC1445). Each comparator's input operates from the negative supply to within 1.3V of the positive supply. The LTC1443/LTC1445 comparator output stage can continuously source up to 40mA. By eliminating the cross-conducting current that normally happens when the comparator changes logic states, the power supply glitches are eliminated.

The LTC1443/LTC1444/LTC1445 are available in the 16-pin SO and PDIP packages.

 LTC and LT are registered trademarks of Linear Technology Corporation.

TYPICAL APPLICATION

Reference Settling Test Circuit

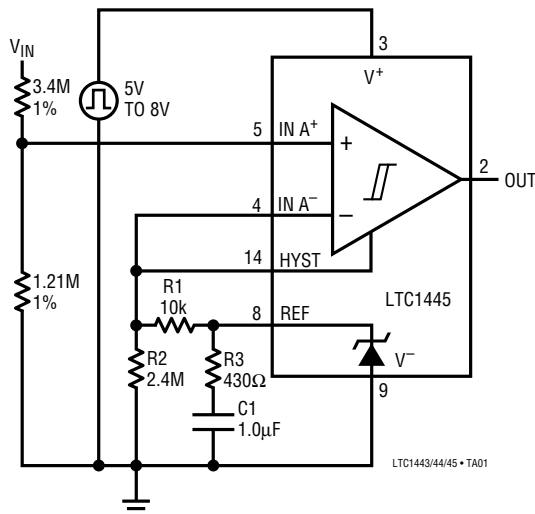

Reference Settling

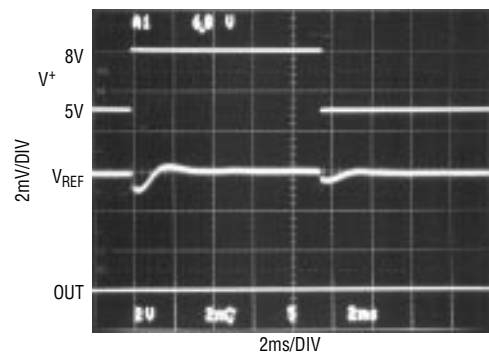

LTC1443/1444/1445 • TA02

LTC1443/LTC1444/LTC1445

ABSOLUTE MAXIMUM RATINGS

Voltage:

V^+ to V^- , V^+ to GND, GND to V^- 12V to -0.3V
 IN^+ , IN^- , HYST (V^+ + 0.3V) to (V^- - 0.3V)
 REF (V^+ + 0.3V) to (V^- - 0.3V)
 OUT (LTC1443) (V^+ + 0.3V) to (GND - 0.3V)
 OUT (LTC1444/LTC1445)
 (V^+ + 0.3V) to (V^- - 0.3V)
 Storage Temperature Range -65°C to 150°C
 Lead Temperature Range (Soldering, 10 sec) 300°C

Current:

IN^+ , IN^- , HYST 20mA
 REF 20mA
 OUT 50mA
 OUT Short Circuit Duration ($V^+ \leq 5.5V$) Continuous
 Power Dissipation 500mW
 Operating Temperature Range
 Commercial 0°C to 70°C
 Industrial -40°C to 85°C

PACKAGE/ORDER INFORMATION

| TOP VIEW | | ORDER PART NUMBER | TOP VIEW | | ORDER PART NUMBER |
|---|---------------------------------|--|---|---------------------------------|--|
| OUT B 1 | 16 OUT C | LTC1443CN LTC1443CS LTC1443IN LTC1443IS | OUT B 1 | 16 OUT C | LTC1444CN LTC1444CS LTC1444IN LTC1444IS LTC1445CN LTC1445CS LTC1445IN LTC1445IS |
| OUT A 2 | 15 OUT D | | OUT A 2 | 15 OUT D | |
| V^+ 3 | 14 GND | | V^+ 3 | 14 HYST | |
| IN^- 4 | 13 IN^- D ⁺ | | IN^- 4 | 13 IN^- D ⁺ | |
| IN^+ 5 | 12 IN^- D ⁻ | | IN^+ 5 | 12 IN^- D ⁻ | |
| IN^- B ⁻ 6 | 11 IN^- C ⁺ | | IN^- B ⁻ 6 | 11 IN^- C ⁺ | |
| IN^- B ⁺ 7 | 10 IN^- C ⁻ | | IN^- B ⁺ 7 | 10 IN^- C ⁻ | |
| REF 8 | 9 V^- | | REF 8 | 9 V^- | |
| N PACKAGE 16-LEAD PDIP | S PACKAGE 16-LEAD PLASTIC SO | | N PACKAGE 16-LEAD PDIP | S PACKAGE 16-LEAD PLASTIC SO | |
| $T_{JMAX} = 150^\circ C, \theta_{JA} = 90^\circ C/W$ (N) $T_{JMAX} = 150^\circ C, \theta_{JA} = 150^\circ C/W$ (S) | | | $T_{JMAX} = 150^\circ C, \theta_{JA} = 90^\circ C/W$ (N) $T_{JMAX} = 150^\circ C, \theta_{JA} = 150^\circ C/W$ (S) | | |

Consult factory for Military grade parts.

ELECTRICAL CHARACTERISTICS $V^+ = 5V, V^- = GND = 0V, T_A = 25^\circ C$ unless otherwise noted.

| SYMBOL | PARAMETER | CONDITIONS | MIN | TYP | MAX | UNITS |
|---------------------|--|--|-----|------------|--------------|---------------|
| Power Supply | | | | | | |
| V^+ | Supply Voltage Range | | ● | 2.0 | 11.0 | V |
| I_{CC} | Supply Current | $IN^+ = IN^- = 80mV$ HYST = REF (LTC1444/LTC1445) | ● | 5.5 | 8.5 | μA |
| Comparator | | | | | | |
| V_{OS} | Comparator Input Offset Voltage | $V_{CM} = 2.5V$ | ● | ± 3.0 | ± 10.0 | mV |
| I_{IN} | Input Leakage Current (IN^+, IN^-) | $V_{IN^+} = V_{IN^-} = 2.5V$ | ● | ± 0.01 | ± 1.0 | nA |
| I_{IN} | Input Leakage Current (HYST) | LTC1444/LTC1445 | ● | ± 0.02 | ± 1.0 | nA |
| V_{CM} | Comparator Input Common Mode Range | | ● | V^- | $V^+ - 1.3V$ | V |
| CMRR | Common Mode Rejection Ratio | V^- to ($V^+ - 1.3V$) | | 0.1 | 1.0 | mV/V |
| PSRR | Power Supply Rejection Ratio | $V^+ = 2V$ to 11V | | 0.1 | 1.0 | mV/V |
| Noise | Voltage Noise | 100Hz to 100kHz | | 20 | | μV_{RMS} |
| V_{HYST} | Hysteresis Input Voltage Range | LTC1444, LTC1445 | ● | REF - 50mV | REF | V |

ELECTRICAL CHARACTERISTICS $V^+ = 5V$, $V^- = GND = 0V$, $T_A = 25^\circ C$ unless otherwise noted.

| SYMBOL | PARAMETER | CONDITIONS | | MIN | TYP | MAX | UNITS | |
|------------------|---------------------------------|--------------------------------------|--------------|--------------|-------|--------------|---------------|---|
| t_{PD} | Propagation Delay | Overdrive = 10mV, $C_{OUT} = 100pF$ | | | 12 | | μs | |
| | | Overdrive = 100mV, $C_{OUT} = 100pF$ | | | 4 | | μs | |
| V_{OH} | Output High Voltage | $I_O = -15mA$; LTC1443/LTC1445 | ● | $V^+ - 0.4V$ | | | V | |
| V_{OL} | Output Low Voltage | $I_O = 1.8mA$; LTC1443 | ● | | | GND + 0.4V | V | |
| | | $I_O = 1.8mA$; LTC1444/LTC1445 | ● | | | $V^- + 0.4V$ | V | |
| Reference | | | | | | | | |
| V_{REF} | Reference Voltage | No Load, LTC1443 | C Temp Range | ● | 1.170 | 1.182 | 1.194 | V |
| | | | I Temp Range | ● | 1.164 | | 1.200 | V |
| | | No Load, LTC1444/ LTC1445 | C Temp Range | ● | 1.209 | 1.221 | 1.233 | V |
| | | | I Temp Range | ● | 1.203 | | 1.239 | V |
| I_{SOURCE} | Reference Output Source Current | $\Delta V_{REF} \leq 1mV$ | ● | 100 | 200 | | μA | |
| I_{SINK} | Reference Output Sink Current | $\Delta V_{REF} \leq 1mV$ | ● | 10 | 15 | | μA | |
| Noise | Voltage Noise | 100Hz to 100kHz | | | 100 | | μV_{RMS} | |

 $V^+ = 3V$, $V^- = GND = 0V$, $T_A = 25^\circ C$ unless otherwise noted.

| SYMBOL | PARAMETER | CONDITIONS | | MIN | TYP | MAX | UNITS | |
|---------------------|---|---|--------------|--------------|------------|--------------|---------------|---|
| Power Supply | | | | | | | | |
| V^+ | Supply Voltage Range | | ● | 2.0 | | 11.0 | V | |
| I_{CC} | Supply Current | $I_{IN^+} = I_{IN^-} = 80mV$, HYST = REF | ● | | 5 | 8 | μA | |
| Comparator | | | | | | | | |
| V_{OS} | Comparator Input Offset Voltage | $V_{CM} = 1.5V$ | ● | | ± 3.0 | ± 10.0 | mV | |
| I_{IN} | Input Leakage Current (I_{IN^+} , I_{IN^-}) | $V_{IN^+} = V_{IN^-} = 1.5V$ | ● | | ± 0.01 | ± 1.0 | nA | |
| I_{IN} | Input Leakage Current (HYST) | LTC1444/LTC1445 | ● | | ± 0.02 | ± 1.0 | nA | |
| V_{CM} | Comparator Input Common Mode Range | | ● | V^- | | $V^+ - 1.3V$ | V | |
| CMRR | Common Mode Rejection Ratio | V^- to $(V^+ - 1.3V)$ | | | 0.1 | 1.0 | mV/V | |
| PSRR | Power Supply Rejection Ratio | $V^+ = 2V$ to 11V | | | 0.1 | 1.0 | mV/V | |
| Noise | Voltage Noise | 100Hz to 100kHz | | | 100 | | μV_{RMS} | |
| V_{HYST} | Hysteresis Input Voltage Range | LTC1444/LTC1445 | ● | REF - 50mV | | REF | V | |
| t_{PD} | Propagation Delay | Overdrive = 10mV, $C_{OUT} = 100pF$ | | | 14 | | μs | |
| | | Overdrive = 100mV, $C_{OUT} = 100pF$ | | | 5 | | μs | |
| V_{OH} | Output High Voltage | $I_O = -10mA$, LTC1443/LTC1445 | ● | $V^+ - 0.4V$ | | | V | |
| V_{OL} | Output Low Voltage | $I_O = 0.8mA$; LTC1443 | ● | | | GND + 0.4V | V | |
| | | $I_O = 0.8mA$; LTC1444/LTC1445 | ● | | | $V^- + 0.4V$ | V | |
| Reference | | | | | | | | |
| V_{REF} | Reference Voltage | No Load, LTC1443 | C Temp Range | ● | 1.170 | 1.182 | 1.194 | V |
| | | | I Temp Range | ● | 1.164 | | 1.200 | V |
| | | No Load, LTC1444/ LTC1445 | C Temp Range | ● | 1.209 | 1.221 | 1.233 | V |
| | | | I Temp Range | ● | 1.203 | | 1.239 | V |
| I_{SOURCE} | Reference Output Source Current | $\Delta V_{REF} \leq 1mV$ | ● | 60 | 120 | | μA | |
| I_{SINK} | Reference Output Sink Current | $\Delta V_{REF} \leq 1mV$ | ● | 10 | 15 | | μA | |
| Noise | Noise Voltage | 100Hz to 100kHz | | | 100 | | μV_{RMS} | |

The ● denotes specifications which apply over the full operating temperature range.

TYPICAL PERFORMANCE CHARACTERISTICS

**LTC1444/LTC1445
Hysteresis Control**

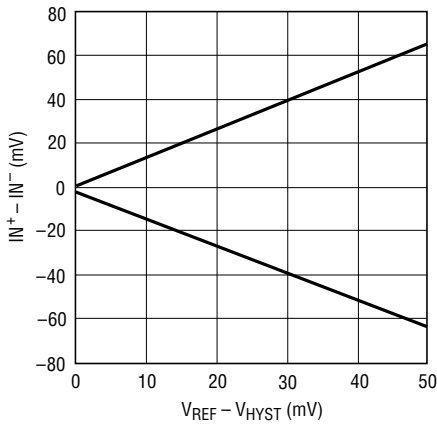

LTC1443/44/45 • TPC01

Supply Current vs Supply Voltage

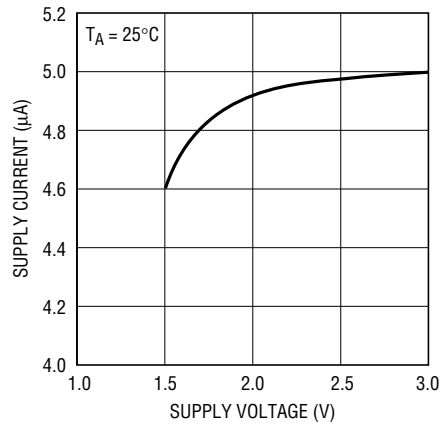

LTC1443/44/45 • TPC02

Supply Current vs Temperature

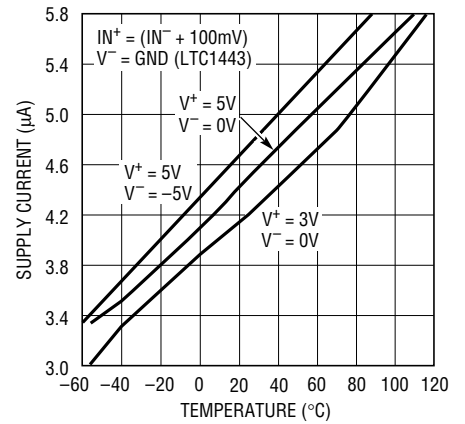

LTC1443/44/45 • TPC03

**LTC1444/LTC1445 Reference
Voltage vs Temperature**

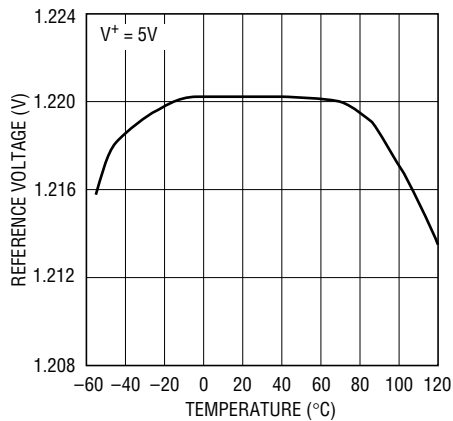

LTC1443/44/45 • TPC04

**LTC1443 Reference Voltage
vs Temperature**

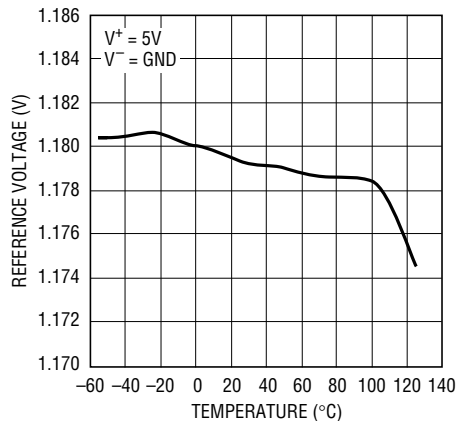

LTC1443/44/45 • TPC05

**LTC1443 Reference Output
Voltage vs Output Load Current**

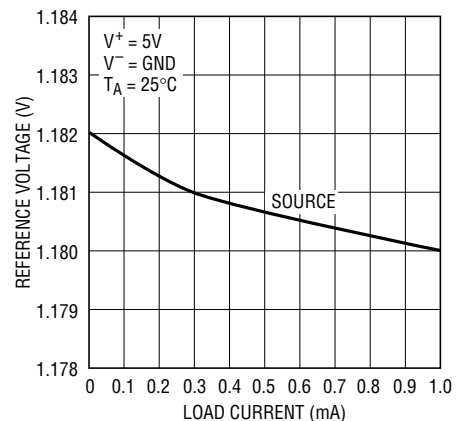

LTC1443/44/45 • TPC06

**LTC1443 Reference Output
Voltage vs Output Load Current**

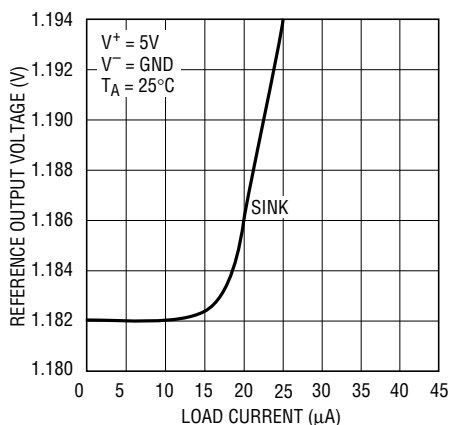

LTC1443/44/45 • TPC07

**Comparator Output Voltage High
vs Load Current**

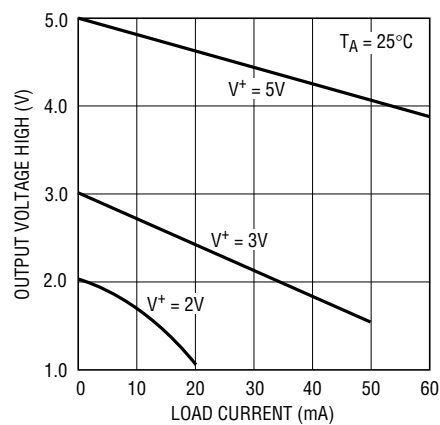

LTC1443/44/45 • TPC08

**Comparator Output Voltage Low
vs Load Current**

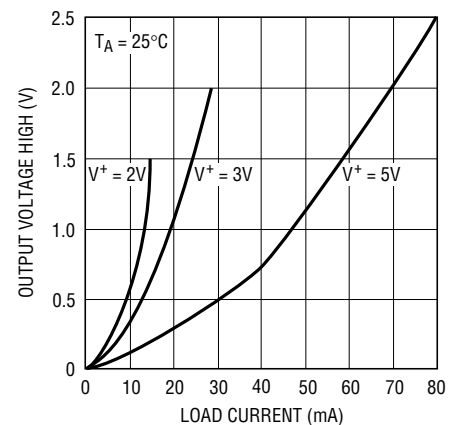

LTC1443/44/45 • TPC09

TYPICAL PERFORMANCE CHARACTERISTICS

Comparator Response Time vs Input Overdrive

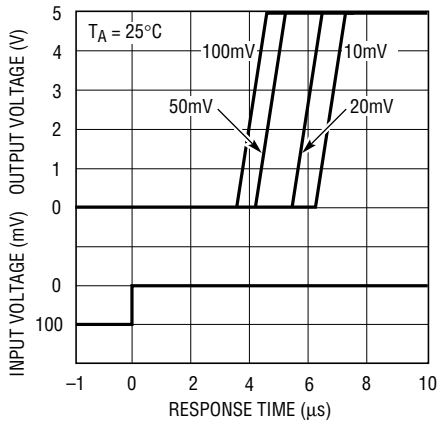

LTC1443/44/45 • TPC10

Comparator Response Time vs Input Overdrives

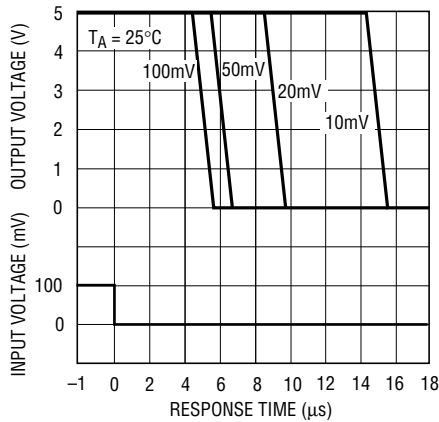

LTC1443/44/45 • TPC11

Comparator Short-Circuit Sink Current vs Supply Voltage

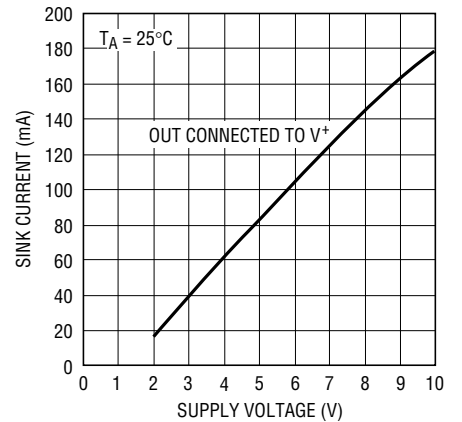

LTC1443/44/45 • TPC12

Comparator Short-Circuit Source Current vs Supply Voltage

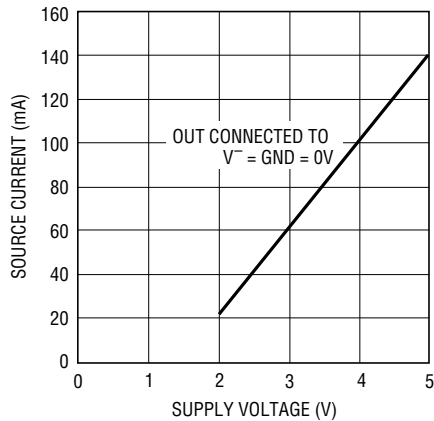

LTC1443/44/45 • TPC13

Comparator Response Time vs Load Capacitance

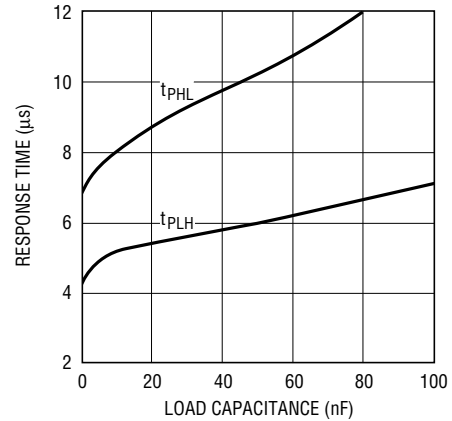

LTC1443/44/45 • TPC14

Supply Current vs Comparator Input Frequency

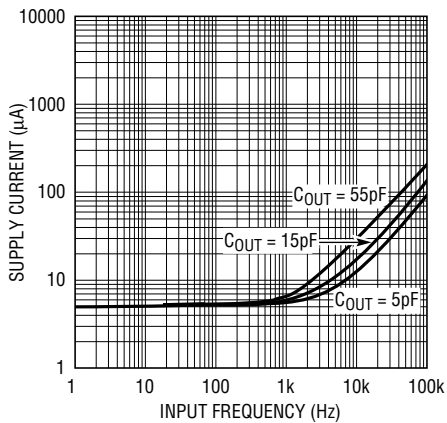

LTC1329 • TPC15

Comparator Response Time at Low Supply Voltage

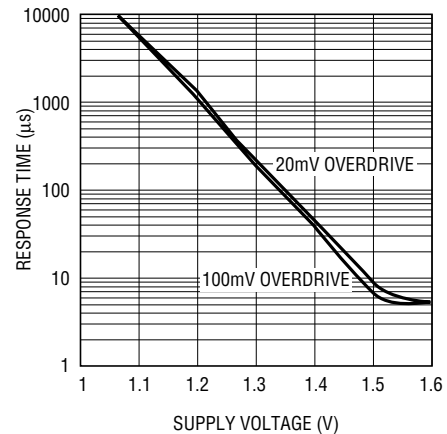

LTC1443/44/45 • TPC16

PIN FUNCTIONS

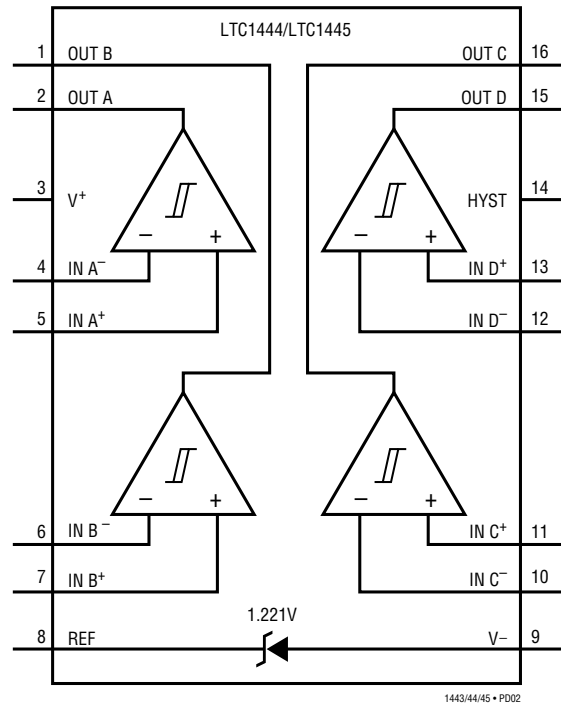
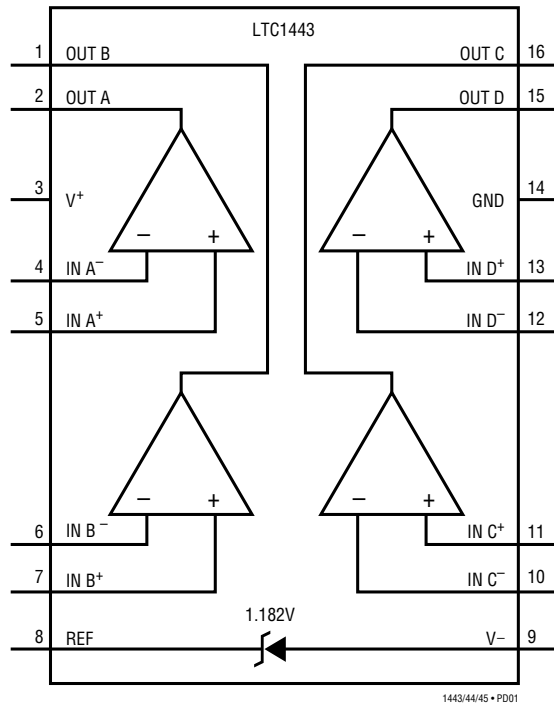

OUT B (Pin 1): Comparator B Output. (Open-drain output for LTC1444). Output can source up to 40mA (LTC1443, LTC1445) and sink 5mA.

OUT A (Pin 2): Comparator A Output. (Open-drain output for LTC1444). Output can source up to 40mA (LTC1443, LTC1445) and sink 5mA.

V⁺ (Pin 3): Positive Supply.

IN A⁻ (Pin 4): Inverting Input of Comparator A. Input common mode range from V⁻ to V⁺ - 1.3V. Input current typically 10pA at 25°C.

IN A⁺ (Pin 5): Noninverting Input of Comparator A. Input common mode range from V⁻ to V⁺ - 1.3V. Input current typically 10pA at 25°C.

IN B⁻ (Pin 6): Inverting Input of Comparator B. Input common mode range from V⁻ to V⁺ - 1.3V. Input current typically 10pA at 25°C.

IN B⁺ (Pin 7): Noninverting Input of Comparator B. Input common mode range from V⁻ to V⁺ - 1.3V. Input current typically 10pA at 25°C.

REF (Pin 8): Reference Output. With respect to V⁻. Can source up to 200μA and sink 15μA at 25°C. Drive 0.01μF bypass capacitor without oscillation.

V⁻ (Pin 9): Negative Supply. Connect to ground for single supply operation on LTC1443. Potential should be more negative than GND.

IN C⁻ (Pin 10): Inverting Input of Comparator C. Input common mode range from V⁻ to V⁺ - 1.3V. Input current typically 10pA at 25°C.

IN C⁺ (Pin 11): Noninverting Input of Comparator C. Input common mode range from V⁻ to V⁺ - 1.3V. Input current typically 10pA at 25°C.

IN D⁻ (Pin 12): Inverting Input of Comparator D. Input common mode range from V⁻ to V⁺ - 1.3V. Input current typically 10pA at 25°C.

IN D⁺ (Pin 13): Noninverting Input of Comparator D. Input common mode range from V⁻ to V⁺ - 1.3V. Input current typically 10pA at 25°C.

GND (Pin 14): LTC1443 Ground. Connect to V⁻ for single supply operation.

HYST (Pin 14): LTC1444/LTC1445 Hysteresis Input. Connect to REF if not used. Input voltage range is from V_{REF} to V_{REF} - 50mV.

PIN FUNCTIONS

OUT D (Pin 15): Comparator D Output. (Open-drain output for LTC1444). Output can source up to 40mA (LTC1443, LTC1445) and sink 5mA.

OUT C (Pin 16): Comparator C Output. (Open-drain output for LTC1444). Output can source up to 40mA (LTC1443, LTC1445) and sink 5mA.

APPLICATIONS INFORMATION

The LTC1443/LTC1444/LTC1445 is a family of quad micropower comparators with built-in reference (1.182V for LTC1443 and 1.221V for LTC1444/LTC1445). Features include programmable hysteresis (LTC1444/LTC1445), wide supply voltage range (2V to 11V) and the ability of the reference to drive up to a 0.01 μ F capacitor without oscillation. The comparator CMOS outputs (LTC1443/LTC1445) can source up to 40mA while the LTC1444 has an open-drain output to V^- . The supply current glitches that normally occur when comparator output switching states have been eliminated.

Power Supplies

The comparator family operates from a single 2V to 11V supply. The LTC1443 includes a separate ground for the comparator output stage, allowing a split supply ranging from ± 1 V to ± 5.5 V. Connecting V^- to GND on the LTC1443 will allow single supply operation. If the comparator output is required to source more than 1mA or the supply source impedance is high, V^+ should be bypassed with a 0.1 μ F capacitor.

Comparator Inputs

The comparator inputs can swing from the negative supply (V^-) to within 1.3V maximum of the positive supply (V^+). The inputs can be forced 300mV below V^- or above V^+ without damage, and the typical input leakage current is only ± 10 pA.

Comparator Outputs

The LTC1443 comparator output swings between GND and V^+ to assure TTL compatibility with a split supply. The LTC1444 and LTC1445 outputs swing between V^- and V^+ . The outputs are capable of sourcing up to 40mA (LTC1443/LTC1445) and sinking up to 5mA while still maintaining microampere quiescent currents. The output stage does not generate crowbar switching currents during transi-

tions which helps minimize parasitic feedback through the supply pins.

Voltage Reference

The internal bandgap reference has a voltage of 1.182V for LTC1443 or 1.221V for LTC1444/LTC1445 referenced to V^- . The reference accuracy is 1.5% from -40°C to 85°C . It can source up to 200 μ A and sink up to 15 μ A with a 5V supply. The reference can drive a bypass capacitor of up to 0.01 μ F without oscillation and by inserting a series resistor, capacitance values up to 100 μ F can be used (Figure 1).

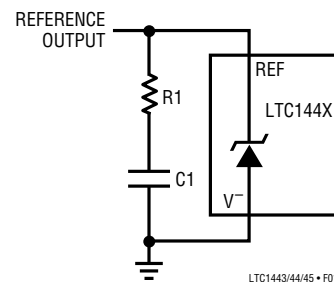

Figure 1. Damping the Reference Output

Figure 2 shows the resistor value required for different capacitor values to achieve critical damping.

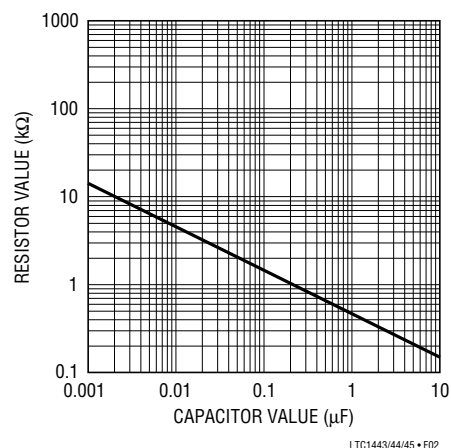

Figure 2. Damping Resistance vs Bypass Capacitor Value

APPLICATIONS INFORMATION

Bypassing the reference can help prevent false tripping of the comparators by preventing glitches on V^+ or reference load transients for disturbing the reference output voltage. Figure 3 shows the bypassed reference output with a square wave applied to the V^+ pin. Resistors R1 and R2 set 10mV of hysteresis, while R3 damps the reference response. Note that the comparator output doesn't trip.

Hysteresis

Hysteresis can be added to the LTC1444/LTC1445 by connecting a resistor (R1) between the REF and HYST pins, and a second resistor (R2) from HYST to V^- (Figure 4).

The difference between the upper and lower threshold voltages or hysteresis voltage band (V_{HB}) is equal to twice the voltage difference between the REF and HYST pins. When more hysteresis is added, the upper threshold increases the same amount as the low threshold decreases. The maximum voltage allowed between REF and HYST is 50mV, producing a maximum hysteresis voltage band of 100mV. If hysteresis is not wanted, the HYST pin should be shorted to REF. Acceptable values for I_{REF} range from 0.1 μ A to 5 μ A. If 2.4M is chosen for R2, then $R1(k\Omega) = V_{HB} (mV)$.

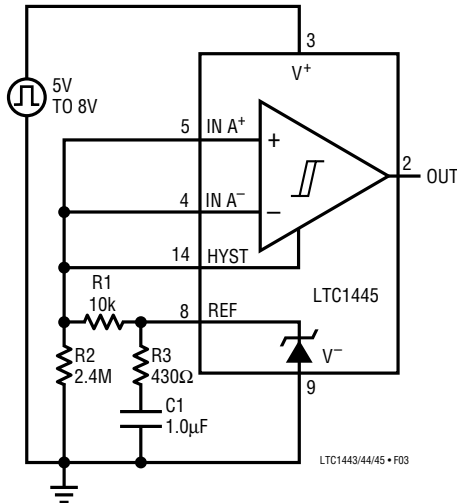

Figure 3a. V^+ Glitching Test Circuit

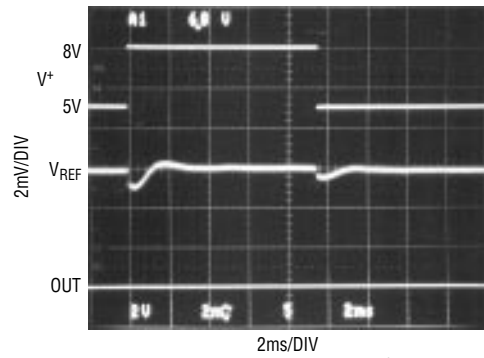

Figure 3b. V^+ Glitching Response

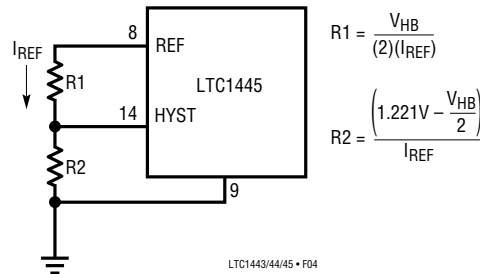

Figure 4. Programmable Hysteresis

APPLICATIONS INFORMATION

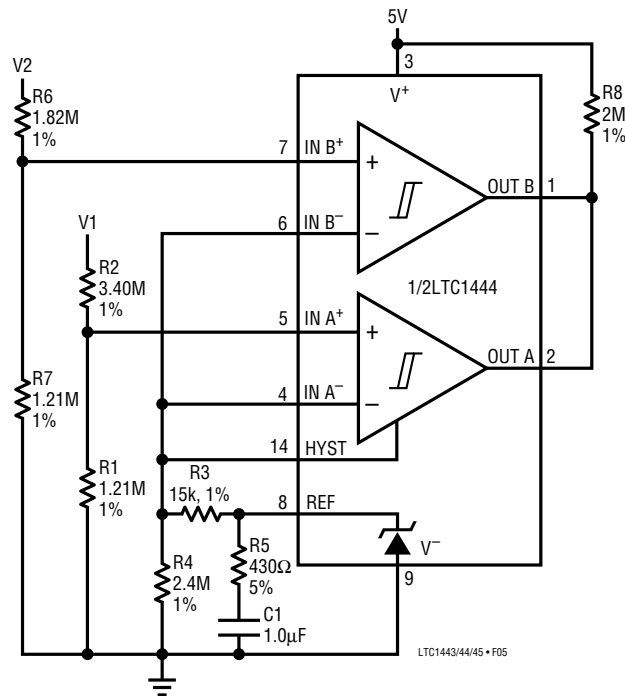

Figure 5. Glitch-Free Level Detector with Hysteresis

Level Detector

The LTC1444 is ideal for use as a multisupply micropower level detector as shown in Figure 5.

R1 and R2 form a voltage divider from V1 to the noninverting comparator A input. R6 and R7 are used to divide down V2, while R8 is the output pull-up resistor for the comparator outputs. R3 and R4 set the hysteresis voltage and R5 and C1 bypass the reference output. The following design procedure can be used to select the component values:

1. Choose the V1 voltage trip level, in this example 4.65V.
2. Calculate the required resistive divider ratio.

$$\text{Ratio} = V_{\text{REF}}/V_{\text{IN}}$$

$$\text{Ratio} = 1.221\text{V}/4.65\text{V} = 0.263$$

3. Choose the required hysteresis voltage band at the input, V_{HBIN} , in this example 60mV. Calculate the hysteresis voltage band referred to the comparator input V_{HB} .

$$V_{\text{HB}} = (V_{\text{HBIN}})(\text{Ratio})$$

$$V_{\text{HB}} = (60\text{mV})(0.263)$$

$$V_{\text{HB}} = 15.78\text{mV}$$

4. Choose the values for R3 and R4 to set the hysteresis.

$$R4 = 2.4\text{M}$$

$$R3(\text{k}\Omega) = V_{\text{HB}} = 15\text{k}$$

5. Choose the values for R1 and R2 to set the trip point.

$$R1 = V_{\text{REF}}/I_{\text{BIAS}} = 1.221\text{V}/1\mu\text{A} \approx 1.21\text{M}$$

$$R2 = (R1) \left[\frac{V_{\text{IN}}}{V_{\text{REF}} + \frac{V_{\text{HB}}}{2}} - 1 \right]$$

$$R2 = (1.21\text{M}) \left[\frac{4.65\text{V}}{1.221\text{V} + \frac{15\text{mV}}{2}} - 1 \right]$$

$$R2 = 3.40\text{M}$$

Using the same equations, R6 and R7 are 1.82M and 1.21M respectively to set the trip level at 3V for V2.

PACKAGE DESCRIPTION Dimensions in inches (millimeters) unless otherwise noted.

N Package
16-Lead PDIP (Narrow 0.300)
 (LTC DWG # 05-08-1510)

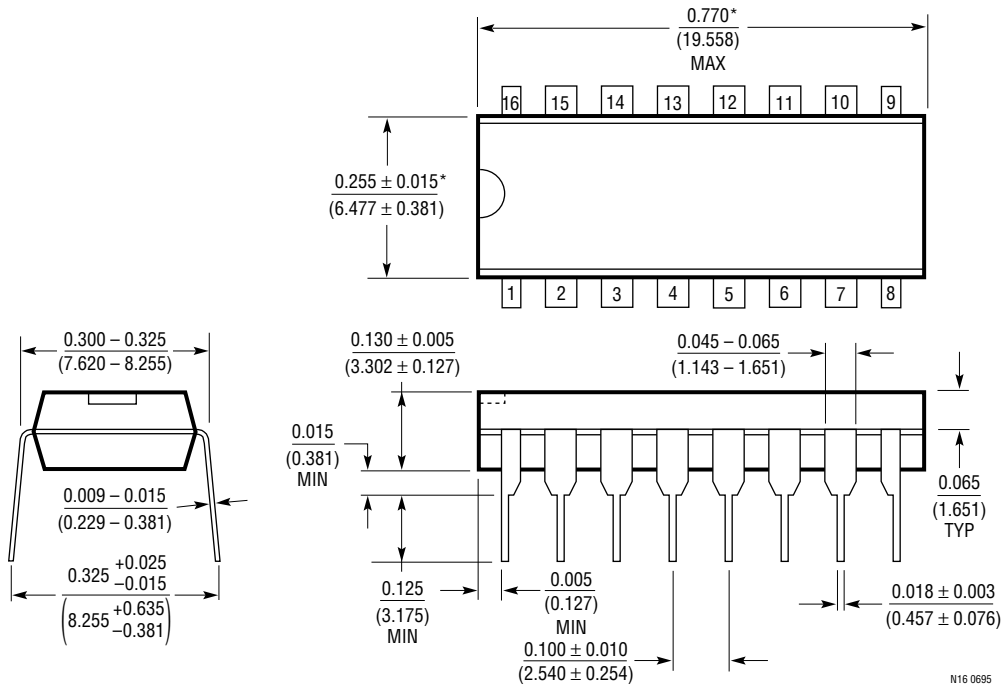

*THESE DIMENSIONS DO NOT INCLUDE MOLD FLASH OR PROTRUSIONS.
 MOLD FLASH OR PROTRUSIONS SHALL NOT EXCEED 0.010 INCH (0.254mm)

N16 0695

PACKAGE DESCRIPTION Dimensions in inches (millimeters) unless otherwise noted.

S Package
16-Lead Plastic Small Outline (Narrow 0.150)
 (LTC DWG # 05-08-1610)

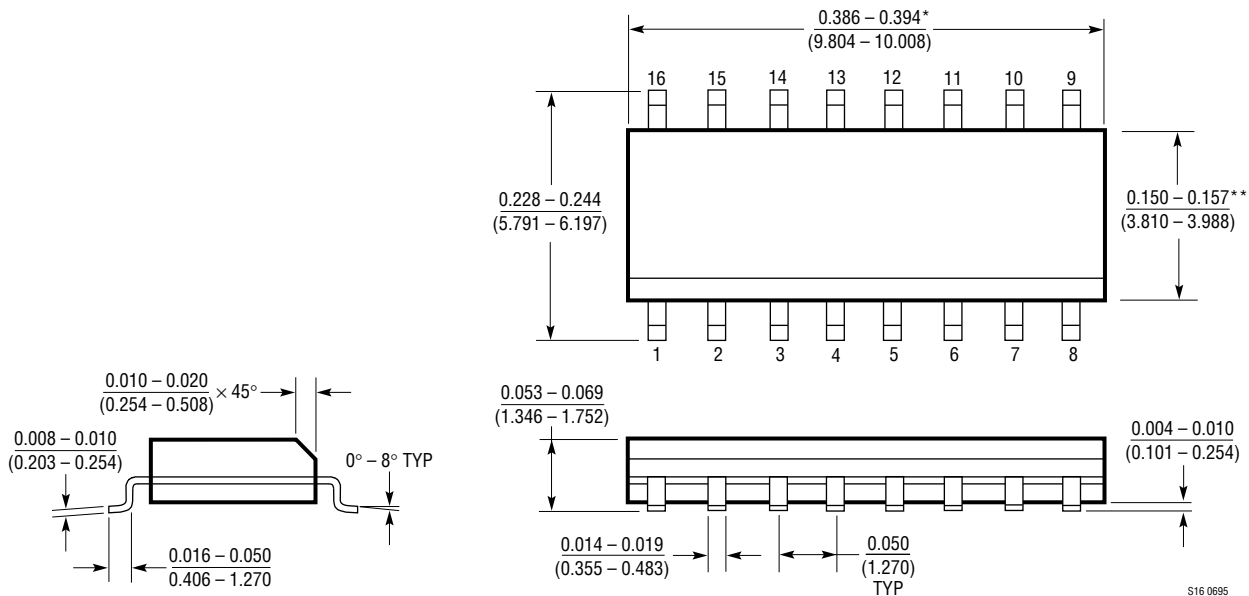

S16 0695

*DIMENSION DOES NOT INCLUDE MOLD FLASH. MOLD FLASH SHALL NOT EXCEED 0.006" (0.152mm) PER SIDE
 **DIMENSION DOES NOT INCLUDE INTERLEAD FLASH. INTERLEAD FLASH SHALL NOT EXCEED 0.010" (0.254mm) PER SIDE

