

MITSUBISHI RF POWER MODULE
M67766C

806-825MHz, 12.5V, 16W, DIGITAL MOBILE RADIO

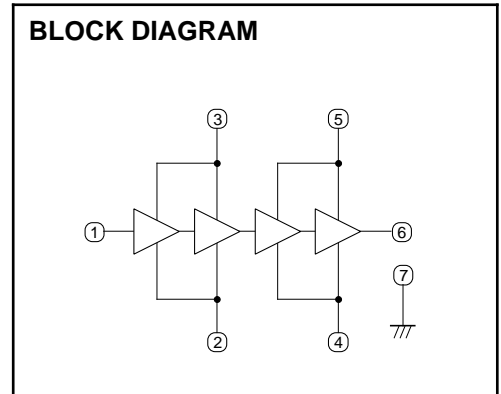
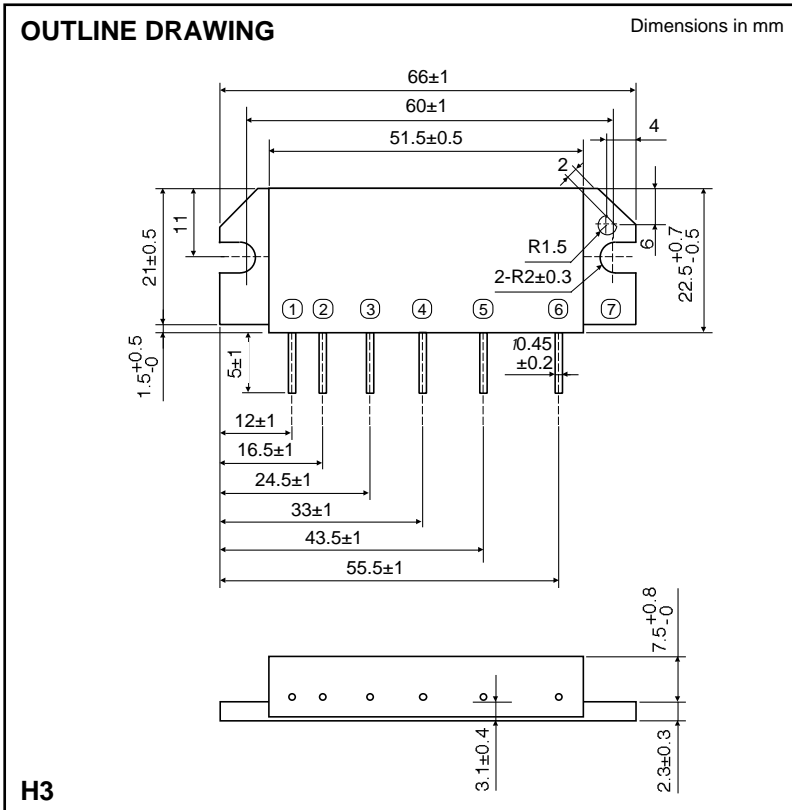

- PIN:
- ① Pin : RF INPUT
 - ② VBB1 : 1st. BASE BIAS SUPPLY
 - ③ VCC1: 1st. COLLECTOR BIAS SUPPLY
 - ④ VBB2: 2nd. BASE BIAS SUPPLY
 - ⑤ VCC2: 2nd. COLLECTOR BIAS SUPPLY
 - ⑥ Po : RF OUTPUT
 - ⑦ GND: FIN

ABSOLUTE MAXIMUM RATINGS (Tc=25°C unless otherwise noted)

Symbol	Parameter	Conditions	Ratings	Unit
VCC1	Supply voltage	ZG=ZL=50 , VBB1=8V	9	V
VCC2	Supply voltage	ZG=ZL=50 , VBB2=8V	17	V
VBB1	Supply voltage	ZG=ZL=50 , VCC1=8V	9	V
VBB2	Supply voltage	ZG=ZL=50 , VCC2=12.5V	9	V
ICC	Total current	ZG=ZL=50	3	A
P _{in} (max)	Input power	ZG=ZL=50 , VCC2=12.5V	10	mW
P _O (max)	Output power	ZG=ZL=50 , VCC2=12.5V	20	W
T _C (OP)	Operation case temperature	ZG=ZL=50	-30 to +110	°C
T _{stg}	Storage temperature		-40 to +110	°C

Note. Above parameters are guaranteed independently.

ELECTRICAL CHARACTERISTICS (Tc=25°C unless otherwise noted)

Symbol	Parameter	Test conditions	Limits		Unit
			Min	Max	
f	Frequency range		806	825	MHz
P _O	Output power	VCC1=VBB=8V, VCC2=12.5V, P _{in} =10dBm, ZG=ZL=50	16		W
η	Total efficiency	VCC1=VBB=8V, VCC2=12.5V, ZG=ZL=50	20		%
2f _o	2nd. harmonic			-30	dBc
in	Input VSWR	PO=6W (P _{in} :controlled)		2.5	-
IMD3	3rd. internal modulation	VCC1=VBB=8V, VCC2=12.5V, ZG=ZL=50 , PO(AVE)=6W(P _{in} :controlled), 2tone, f=10kHz		-24	dBc
IMD5	5th. internal modulation			-28	dBc
-	Load VSWR tolerance	VCC1=8.5V, VBB=8V, VCC2=17V, PO=20W (P _{in} :controlled), ZG=50 , Load VSWR < 2:1	No degradation or destroy		-

Note. Above parameters, ratings, limits and test conditions are subject to change.

TYPICAL PERFORMANCE DATA

OUTPUT POWER, EACH CURRENT VS. FREQUENCY

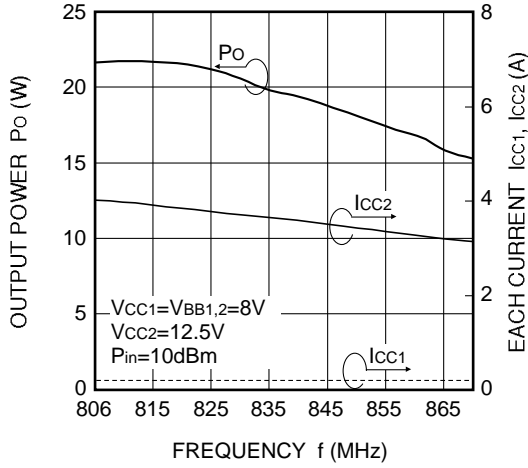

SUPRIUS, IMD VS. FREQUENCY

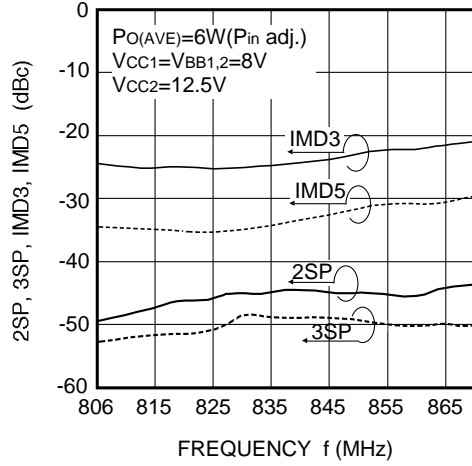

INPUT POWER, INPUT VSWR, TOTAL EFFICIENCY VS. FREQUENCY

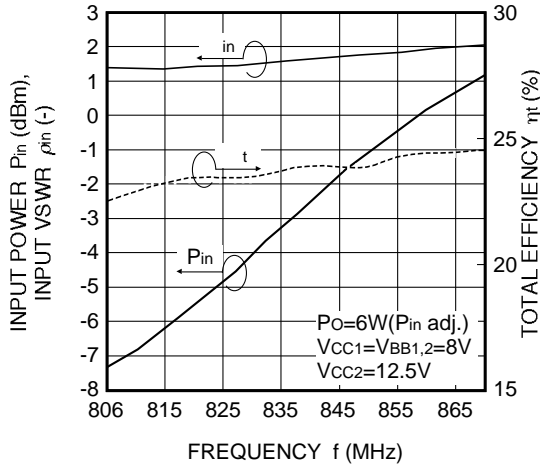

OUTPUT POWER, EACH CURRENT VS. INPUT POWER

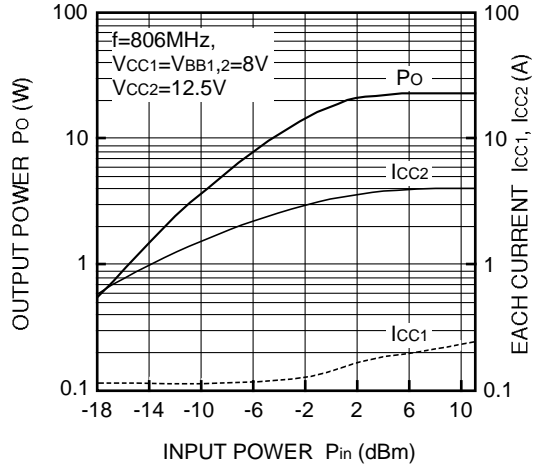

OUTPUT POWER, EACH CURRENT VS. INPUT POWER

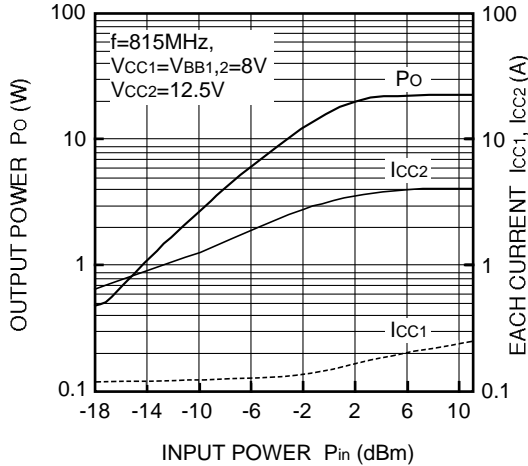

OUTPUT POWER, EACH CURRENT VS. INPUT POWER

