

PQ05RR1/11/1B

1A Output, Low Power-Loss Voltage Regulators(Built-in Reset Signal Generating Function)

■ Features

- Low power-loss (Dropout voltage : MAX. 0.5V)
- Compact resin full-mold package
- Built-in reset signal generating function to prevent errors of microcomputer when the output voltage drops.
- Lead forming type (PQ05RR1B) is also available.

■ Applications

- Series power supply for equipment provided with microcomputer such as electronic musical instruments and VCRs

■ Model Line-ups

Output voltage	5V output
Output voltage precision:±5%	PQ05RR1
Output voltage precision:±2.5%	PQ05RR11

■ Outline Dimensions

(Unit : mm)

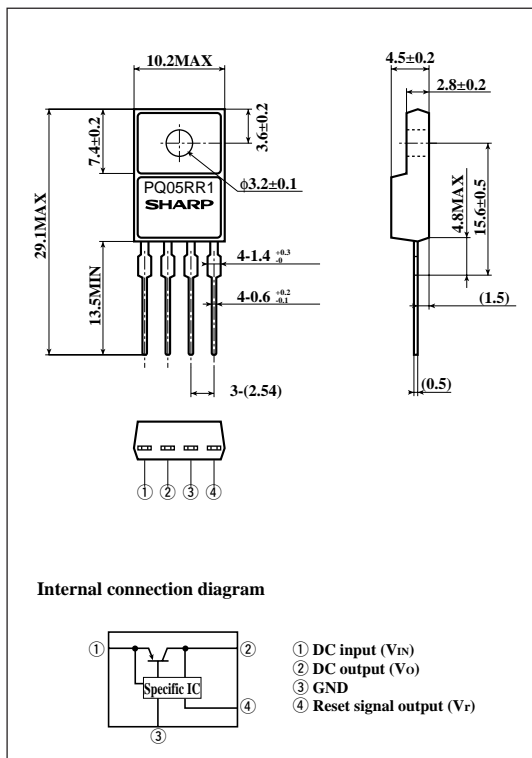

■ Absolute Maximum Ratings

(T_a=25°C)

Parameter	Symbol	Rating	Unit
*1 Input voltage	V _{IN}	35	V
*1 Reset output voltage	V _r	35	V
Output current	I _O	1	A
Reset output current	I _r	10	mA
Power dissipation(No heat sink)	P _{D1}	1.5	W
*2 Power dissipation(With infinite heat sink)	P _{D2}	15	W
Junction temperature	T _j	150	°C
Operating temperature	T _{opr}	-20 to +80	°C
Storage temperature	T _{stg}	-40 to +150	°C
Soldering temperature	T _{sol}	260 (For 10s)	°C

*1 All are open except GND and applicable terminals.

*2 Overheat protection may operate at 125<T_j<150°C

· Please refer to the chapter " Handling Precautions ".

SHARP

" In the absence of confirmation by device specification sheets, SHARP takes no responsibility for any defects that may occur in equipment using any SHARP devices shown in catalogs, data books, etc. Contact SHARP in order to obtain the latest version of the device specification sheets before using any SHARP's device. "

■ Electrical Characteristics

(Unless otherwise specified, condition shall be $V_{IN}=7V$, $I_o=0.5A$, $T_a=25^{\circ}C$)

Parameter	Symbol	Conditions	MIN.	TYP.	MAX.	Unit
Output voltage	PQ05RR1	-	4.75	5.0	5.25	V
	PQ05RR11		4.88	5.0	5.12	
Load regulation	R_{eL}	$I_o=5mA$ to 1.0A	-	0.1	2.0	%
Line regulation	R_{eI}	$V_{IN}=6$ to 12V	-	0.5	2.5	%
Temperature coefficient of output voltage	T_cV_o	$T_j=0$ to $125^{\circ}C$	-	± 0.02	-	$\%/^{\circ}C$
Ripple rejection	RR	Refer to Fig. 2	45	55	-	dB
Dropout voltage	V_{i-o}	*3	-	-	0.5	V
Low reset output voltage	V_{rl}	$I_o=5mA$, $I_r=5mA$	-	-	0.8	V
Reset threshold voltage	V_{rt}	$I_o=5mA$	$V_o-0.25$	-	$V_o-0.1$	V
Reset output leak current	I_{rlk}	$I_o=5mA$, $V_r=35V$	-	-	30	μA
Quiescent current	I_q	$I_o=0$	-	-	10	mA

*3 Input voltage shall be the value when output voltage is 95% in comparison with the initial value.

Fig.1 Test Circuit

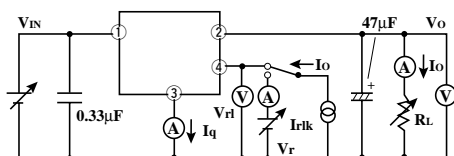
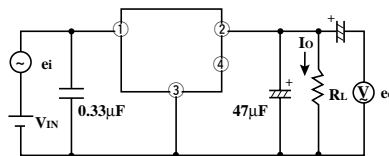
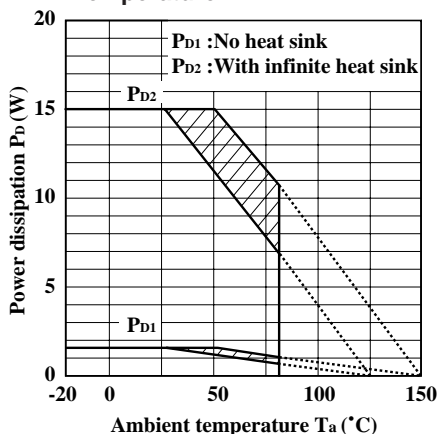

Fig.2 Test Circuit of Ripple Rejection



$f=120Hz$ (sine wave)
 $e_i=0.5V_{rms}$
 $RR=20 \log (e_i/e_o)$

Fig.3 Power Dissipation vs. Ambient Temperature



Note) Oblique line portion: Overheat protection may operate in this area.

Fig.4 Overcurrent Protection Characteristics (Typical Value)

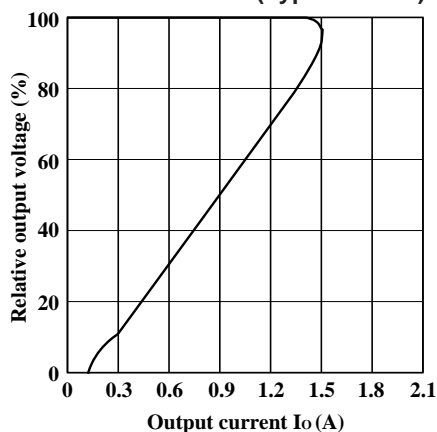

Fig.5 Output Voltage Deviation vs. Junction Temperature

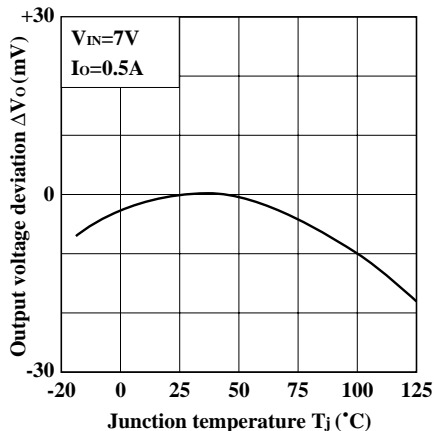

Fig.6 Output Voltage vs. Input Voltage (Typical Value)

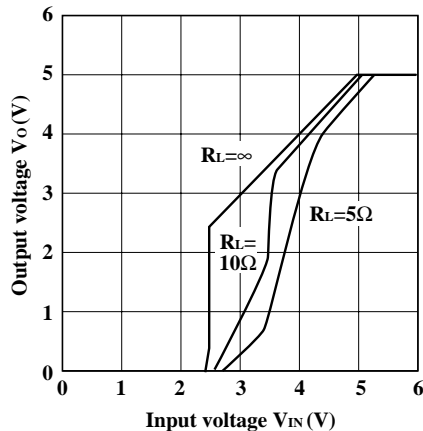

Fig.7 Circuit Operating Current vs. Input Voltage (Typical Value)

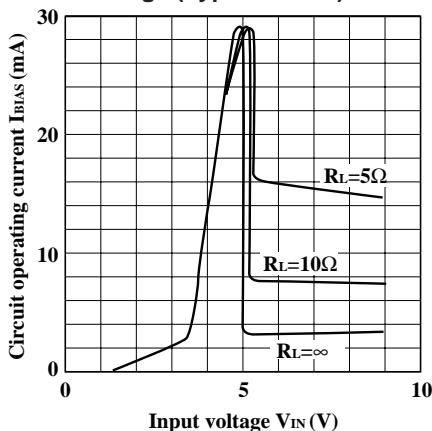

Fig.8 Quiescent Current vs. Junction Temperature

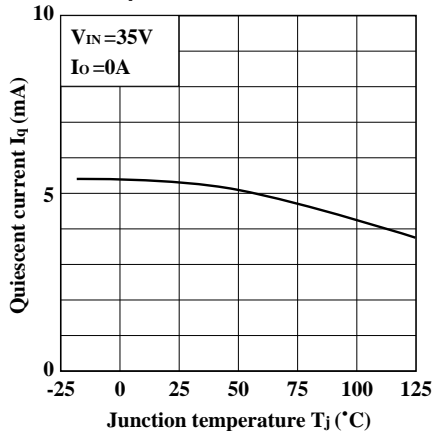

Fig.9 Ripple Rejection vs. Input Ripple Frequency

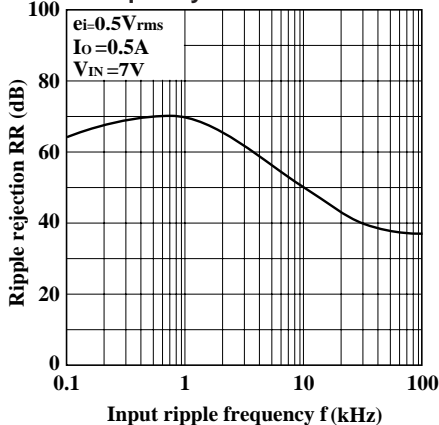

Fig.10 Ripple Rejection vs. Output Current

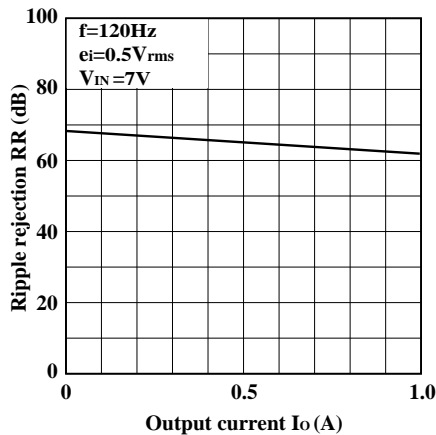

Fig.11 Output Peak Current vs. Junction Temperature

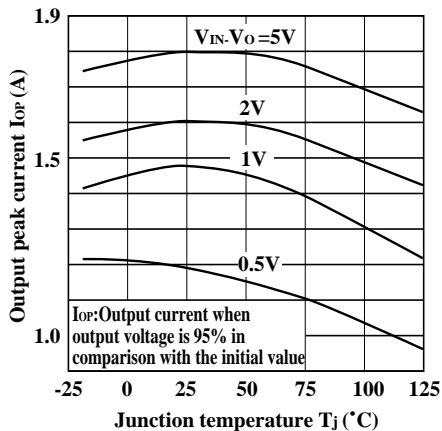

Fig.12 Output Peak Current vs. Dropout Voltage

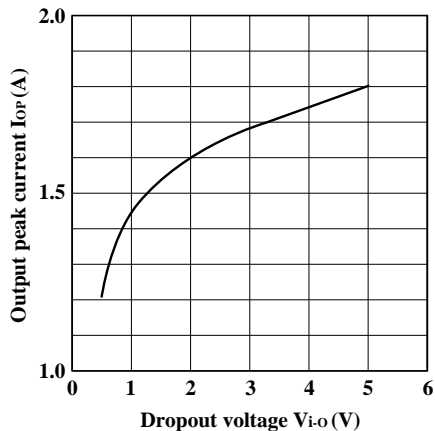
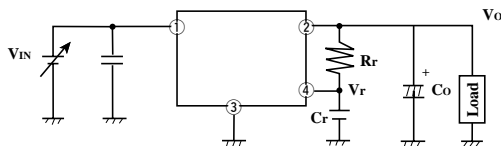
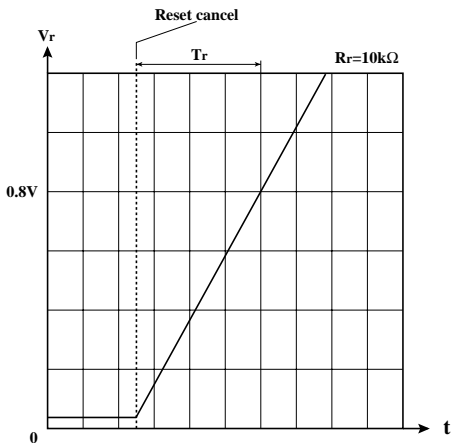
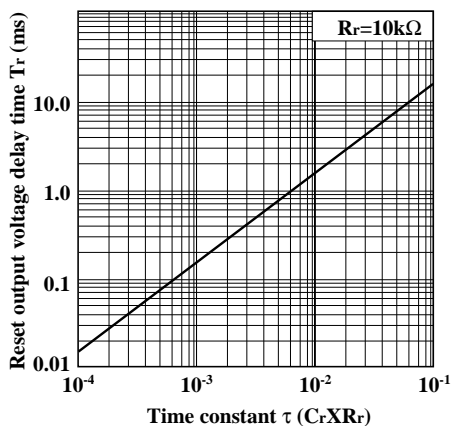
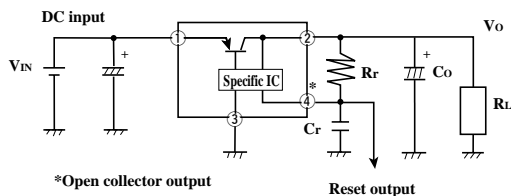

Fig.13 Reset Output Delay Time vs. Time Constant



■ Typical Application



■ Reset Output Response Characteristics

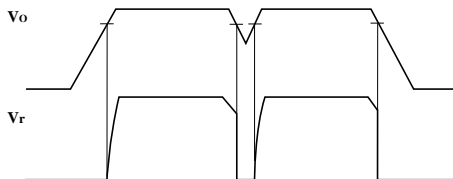

■ Model Line-up for Lead Forming Type

Output voltage	5Voutput
Output voltage precision:±2.5%	PQ05RR1B

■ Outline Dimensions

(Unit : mm)

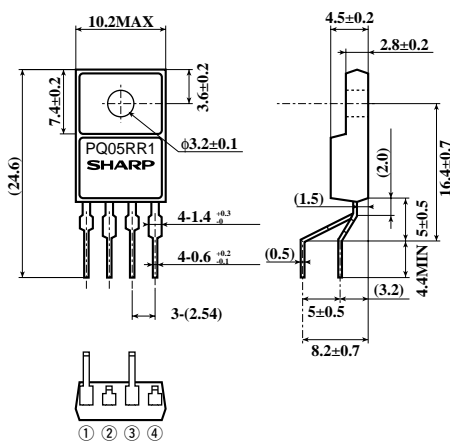

- () : Typical value
- Radius of lead forming portion : R=0.5 to 1.5mm

Internal connection diagram

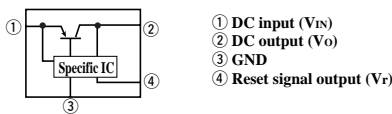

Note) The value of absolute maximum ratings and electrical characteristics is same as ones of PQ05RR11.