

DATA SHEET

TDA1593

IF amplifier/demodulator for
FM car radio receivers

Product specification
Supersedes data of 1995 May 29
File under Integrated Circuits, IC01

1996 Oct 10

IF amplifier/demodulator for FM car radio receivers

TDA1593

FEATURES

- Balanced limiting amplifier
- Balanced coincidence demodulator
- Two open-collector stop pulse outputs for microcomputer tuning control
- Simulated behaviour of ratio detector (internal field strength and detuning dependent voltage for dynamic AF signal muting)
- Mono/stereo blend field strength indication control voltage
- AFC output
- Internal compensation of AF signal total harmonic distortion (THD)
- Built-in hum and ripple rejection circuits.

GENERAL DESCRIPTION

The TDA1593 provides IF amplification, symmetrical quadrature demodulation and level detection for quality FM car radio receivers and is suitable for mono and stereo reception. It may also be applied to common front ends, stereo decoders and AM receivers circuits.

All pin numbers mentioned in this data sheet refer to the SO-version (TDA1593T) unless otherwise specified.

QUICK REFERENCE DATA

SYMBOL	PARAMETER	MIN.	TYP.	MAX.	UNIT
V_P	supply voltage (pin 1)	7.5	8.5	12	V
I_P	supply current ($I_2 = 0$)	–	20	26	mA
V_{iIF}	IF input sensitivity for limiting on pin 20 (RMS value)	14	22	35	μ V
V_{oAF}	AF output signal on pin 4 (RMS value)	180	200	220	mV
S/N	signal-to-noise ratio ($f_m = 400$ Hz; $\Delta f = \pm 75$ kHz)	–	82	–	dB
THD	total harmonic distortion ($f_m = 1$ kHz; $\Delta f = \pm 75$ kHz)	–	0.2	0.6	%
T_{amb}	operating ambient temperature	–40	–	+85	$^{\circ}$ C

ORDERING INFORMATION

TYPE NUMBER	PACKAGE		
	NAME	DESCRIPTION	VERSION
TDA1593	DIP18	plastic dual in-line package; 18 leads (300 mil)	SOT102-1
TDA1593T	SO20	plastic small outline package; 20 leads; body width 7.5 mm	SOT163-1

IF amplifier/demodulator for FM car radio receivers

TDA1593

BLOCK DIAGRAM

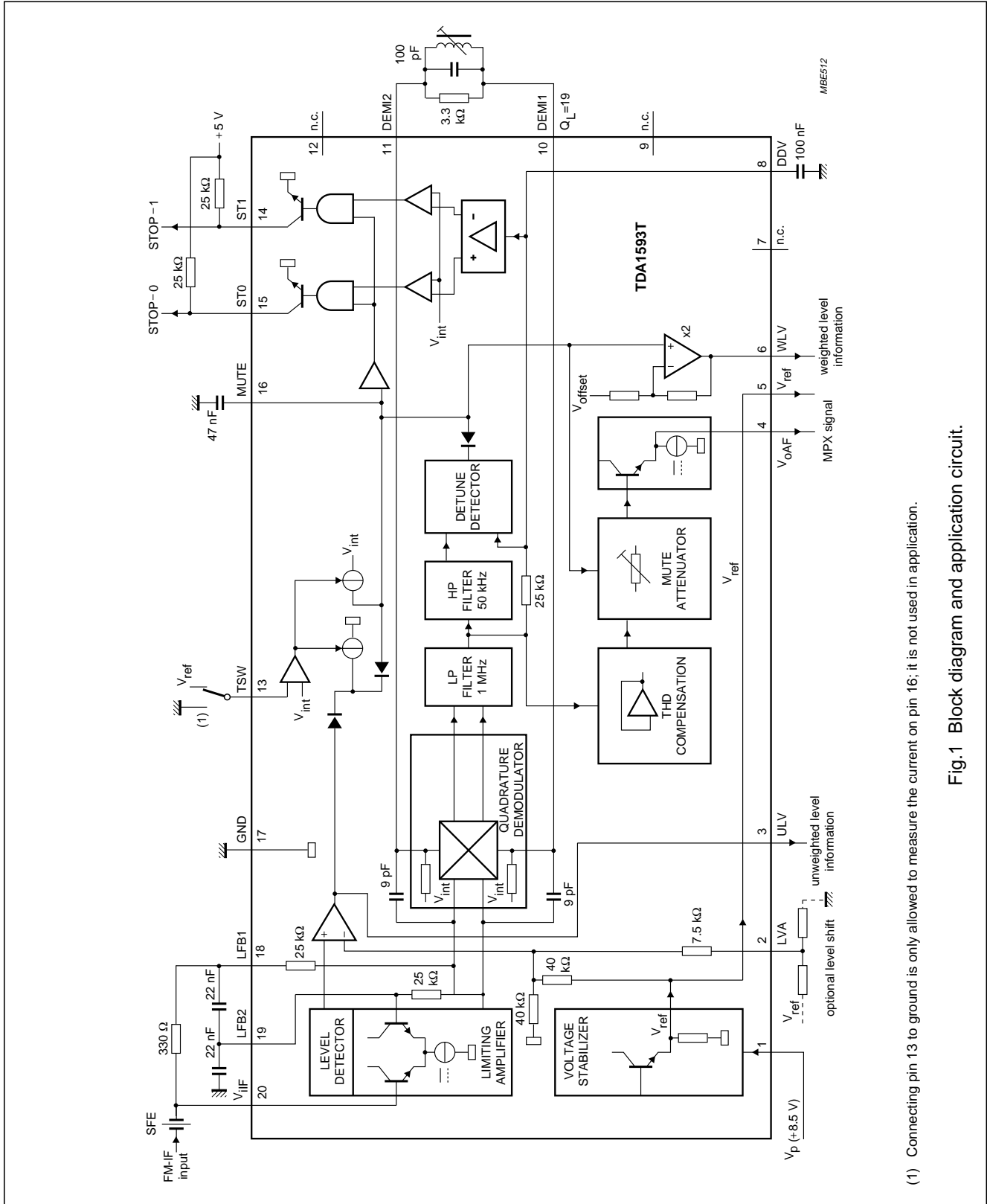

(1) Connecting pin 13 to ground is only allowed to measure the current on pin 16; it is not used in application.

Fig. 1 Block diagram and application circuit.

IF amplifier/demodulator for FM car radio receivers

TDA1593

PINNING

SYMBOL	PIN		DESCRIPTION
	SOT102-1 DIP18	SOT163-1 SO20	
V _P	1	1	supply voltage (+8.5 V)
LVA	2	2	level adjustment for stop condition
ULV	3	3	unweighted level output
V _{oAF}	4	4	audio frequency output (MPX signal)
V _{ref}	5	5	reference voltage output
WLV	6	6	weighted level output
n.c.	7	7	not connected
DDV	8	8	detune detector voltage
n.c.	–	9	not connected
DEMI1	9	10	demodulator input 1
DEMI2	10	11	demodulator input 2
n.c.	–	12	not connected
TSW	11	13	tau switch input
ST1	12	14	STOP-1, stop pulse output 1
ST0	13	15	STOP-0, stop pulse output 0
MUTE	14	16	muting voltage
GND	15	17	ground (0 V)
LFB1	16	18	IF limiter feedback 1
LFB2	17	19	IF limiter feedback 2
V _{iIF}	18	20	IF signal input

IF amplifier/demodulator for FM car radio receivers

TDA1593

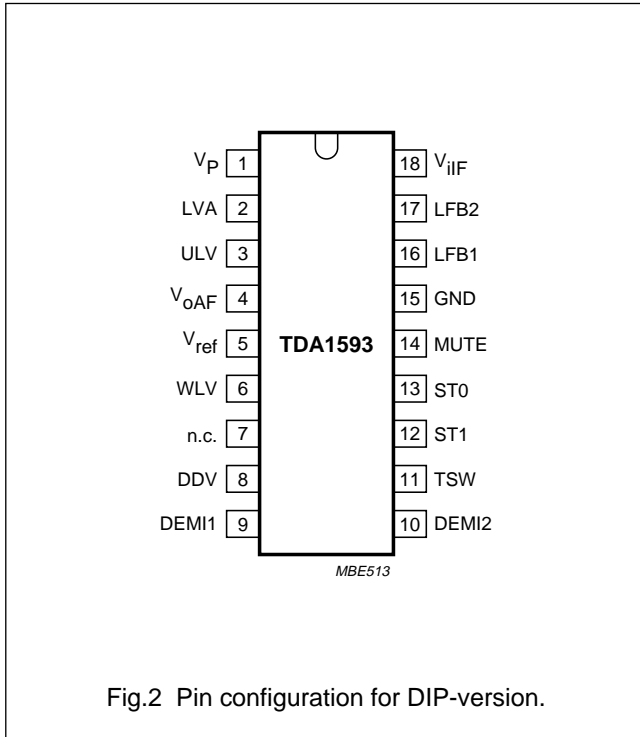

Fig.2 Pin configuration for DIP-version.

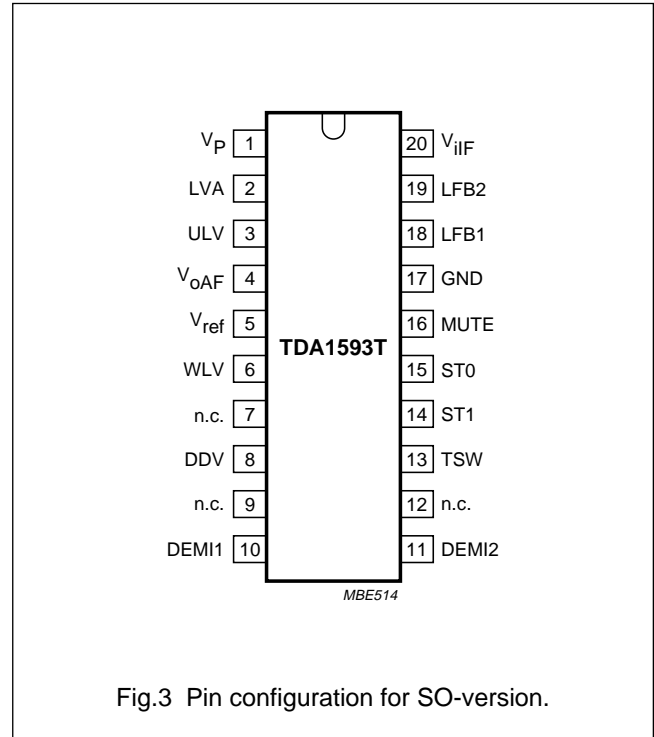

Fig.3 Pin configuration for SO-version.

FUNCTIONAL DESCRIPTION

The limiter amplifier has five stages of IF amplification using balanced differential limiter amplifiers with emitter follower coupling.

Decoupling of the stages from the supply voltage line and an internal high-ohmic DC feedback loop give a very stable IF performance. The amplifier gain is virtually independent of changes in temperature.

The FM demodulator is fully balanced and comprises two cross-coupled differential amplifiers.

The quadrature detection of the FM signal is performed by direct feeding of one differential amplifier from the limiter amplifier output, and the other via an external 90 degrees phase shifting network. The demodulator has a good stability and a small zero-cross-over shift. The bandwidth of the demodulator output is restricted by an internal low-pass filter to approximately 1 MHz. Non-linearities, which are introduced by demodulation, are compensated by the THD compensation circuit. For this reason, the demodulator resonance circuit (between pins 10 and 11)

must have a loaded Q-factor of 19. Consequently, there is no need for the demodulator tuned circuit to be adjusted for minimum distortion. Adjustment criterion is a symmetrical stop pulse. The control voltage for the mute attenuator (pin 16) is derived from the values of the level detector and the detuning detector output signals. The mute attenuator has a fast attack and a slow decay determined by the capacitor on pin 16. The AF signal is fed via the mute attenuator to the output (pin 4). A weighted control voltage (pin 6) is obtained from the mute attenuator control voltage via a buffer amplifier that introduces an additional voltage shift and gain.

The level detector generates a voltage output signal proportional to the amplitude of the input signal. The unweighted level detector output signal is available. The open-collector tuning stop output voltages STOP-0 and STOP-1 (pins 15 and 14) are derived from the detuning and the input signal level. The pins 14 and 15 may be tied together, if only one tuning-stop output is required.

IF amplifier/demodulator for FM car radio receivers

TDA1593

LIMITING VALUES

TDA1593T pinning

In accordance with the Absolute Maximum Rating System (IEC 134).

SYMBOL	PARAMETER	MIN.	MAX.	UNIT
V_P	supply voltage (pin 1)	-0.3	+13	V
V_n	voltage at pins 2, 4, 5, 6, 10, 11 and 16	-0.3	+10	V
	voltage at pins 3, 8, 14, 15, 18, 19 and 20	-0.3	V_P	V
V_{13}	voltage on pin 13	-	6	V
$I_{14, 15}$	current at pins 14 and 15	-	2	mA
P_{tot}	total power dissipation	-	360	mW
T_{stg}	storage temperature	-55	+150	°C
T_{amb}	operating ambient temperature	-40	+85	°C
V_{es}	electrostatic handling; note 1			
	all pins except pin 5	-2000	+2000	V
	pin 5	-2000	+800	V

Note

1. Equivalent to discharging a 100 pF capacitor through a 1.5 kΩ series resistor.

THERMAL CHARACTERISTICS

SYMBOL	PARAMETER	VALUE	UNIT
$R_{th\ j-a}$	thermal resistance from junction to ambient in free air		
	SOT102-1	80	K/W
	SOT163-1	90	K/W

IF amplifier/demodulator for FM car radio receivers

TDA1593

CHARACTERISTICS

$V_P = 8.5$ V; $T_{amb} = +25$ °C; $f_{IF} = 10.7$ MHz; deviation ± 22.5 kHz with $f_m = 400$ Hz; $V_i = 10$ mV (RMS) at pin 20; de-emphasis of 50 μ s; tuned circuit at pins 10 and 11 aligned for symmetrical stop pulses; measurements taken in Fig.4 unless otherwise specified.

SYMBOL	PARAMETER	CONDITIONS	MIN.	TYP.	MIN.	UNIT
V_P	supply voltage (pin 1)		7.5	8.5	12	V
I_P	supply current	$I_2 = 0$	–	20	26	mA
IF amplifier and demodulator						
Z_i	demodulator input impedance between pins 10 and 11		25	40	55	k Ω
C_i	demodulator input capacitance between pins 10 and 11		–	6	–	pF
AF output (pin 4)						
R_o	output resistance		–	400	–	Ω
V_4	DC output level	$V_{iIF} \leq 5$ μ V (RMS) on pin 20	2.75	3.1	3.45	V
PSRR	power supply ripple rejection (pin 4)	$f = 1000$ Hz; $V_{ripple} = 50$ mV (RMS)	33	36	–	dB
Tuning stop detector						
Δf_{STOP-0}	detuning frequency for STOP-0 (pin 15)	see Fig.9 $V_{15} \geq 3.5$ V $V_{15} \leq 0.3$ V	– +22.0	– –	+14.0 –	kHz kHz
Δf_{STOP-1}	detuning frequency for STOP-1 (pin 14)	see Fig.8 $V_{14} \geq 3.5$ V $V_{14} \leq 0.3$ V	– –22.0	– –	–14.0 –	kHz kHz
V_{20}	dependency on input voltage for STOP-0 and STOP-1 (RMS value)	see Fig.7 $V_{14, 15} \geq 3.5$ V $V_{14, 15} \leq 0.3$ V	250 –	– –	– 50	μ V μ V
$V_{14, 15}$	output voltage	$I_{14, 15} = 1$ mA	–	–	0.3	V
Reference voltage source (pin 5)						
V_{ref}	reference output voltage	$I_5 = -1$ mA	3.3	3.7	4.1	V
R_5	output resistance	$I_5 = -1$ mA	–	40	80	Ω
TC	temperature coefficient		–	3.3	–	mV/K
External muting						
V_{16}	muting voltage at $I_2 = 0$	$V_{20} \leq 5$ μ V (RMS); see Fig.10 $V_{20} = 1$ mV (RMS)	1.45 3.0	1.75 3.45	2.05 3.9	V V
S	steepness of control voltage	slope: 100 μ V $\leq V_{20} \leq 100$ mV; $20 \Delta \log V_{20} = 20$ dB $\left(\frac{\Delta V_{16}}{\Delta \log V_{20}} \right)$	–	0.85	–	V/dec

IF amplifier/demodulator for FM car radio receivers

TDA1593

SYMBOL	PARAMETER	CONDITIONS	MIN.	TYP.	MIN.	UNIT
Internal mute α; note 1						
α	mute voltage	$V_{16} \geq V_{ref}$	–	0	–	dB
		$V_{16} = 0.77V_{ref}$	1.5	–	4.5	dB
		$V_{16} = 0.55V_{ref}$	–	20	–	dB
I_{16}	current for capacitor (pin 16)					
	charge current	$V_{13} = 0\text{ V}$	–	–8	–	μA
	discharge current	$V_{13} = 0\text{ V}$	–	+120	–	μA
	charge current	$V_{13} = V_{ref}$	–	–100	–	μA
	discharge current	$V_{13} = V_{ref}$	–	+120	–	μA
Level detector						
R_6	output resistance		–	–	500	Ω
V_6	output voltage at $I_2 = 0$	$V_{20} \leq 5\text{ }\mu\text{V (RMS)}$; see Fig.11	0.1	–	1.1	V
		$V_{20} = 1\text{ mV (RMS)}$	3.0	–	4.2	V
		$\pm 200\text{ kHz detuning}$	1.2	1.5	1.8	V
ΔV_6	output voltage at detuning	$\pm 45\text{ kHz detuning}$	–	–	0.2	V
TC	temperature coefficient		–	3.3	–	mV/K
S	steepness of control voltage	slope: $50\text{ }\mu\text{V} \leq V_{20} \leq 50\text{ mV}$; $20\text{ }\Delta\log V_{20} = 20\text{ dB}$ $\left(\frac{\Delta V_6}{\Delta \log V_{20}} \right)$	1.4	1.7	2.0	V/dec
$\Delta V_6/\Delta f$	slope of output voltage at detuning	$\Delta f = 125 \pm 20\text{ kHz}$	–	35	–	mV/kHz
S	level shift adjustments					
	range by pin 2	$\pm \Delta V_6/V_{ref}$	0.42	0.5	–	V/V
	gain	$-\Delta V_6/\Delta V_2$	–	1.7	–	V/V
	range by pin 2	$\pm \Delta V_{16}/V_{ref}$	0.21	0.25	–	V/V
	gain	$-\Delta V_{16}/\Delta V_2$	–	0.85	–	V/V

Note

$$1. \quad \alpha = 20 \log \frac{\Delta V_{4(FM-MUTE-OFF)}}{\Delta V_{4(FM-MUTE-ON)}}$$

IF amplifier/demodulator for FM car radio receivers

TDA1593

OPERATING CHARACTERISTICS

$V_P = 7.5$ to 12 V; $T_{amb} = +25$ °C; $f_{IF} = 10.7$ MHz; deviation ± 22.5 kHz with $f_m = 400$ Hz; $V_i = 10$ mV (RMS) at pin 20; de-emphasis of 50 μ s; tuned circuit at pins 10 and 11 aligned for symmetrical stop pulses; measurements taken in Fig.4 unless otherwise specified.

SYMBOL	PARAMETER	CONDITIONS	MIN.	TYP.	MIN.	UNIT
IF amplifier and demodulator						
V_i	input signal for start of limiting (-3 dB) (RMS value; pin 20)	$V_{16} = 4.5$ V	14	22	35	μ V
	input signal for signal-to-noise ratio (RMS value)	$f = 250$ to 15000 Hz; $V_{16} = 4.5$ V	–	15	–	μ V
		S/N = 26 dB S/N = 46 dB	–	60	–	μ V
S/N	signal-to-noise ratio	deviation ± 75 kHz; $f_m = 400$ Hz	–	82	–	dB
V_o	AF output signal (RMS value; pin 4)		180	200	220	mV
THD	total harmonic distortion without de-emphasis ± 25 kHz detuning	deviation ± 75 kHz; $f_m = 1$ kHz	–	0.2	0.6	%
			–	–	1.0	%
α_{AM}	AM suppression on pin 4 $V_i = 0.3$ to 1000 mV (RMS) $V_i = 1$ to 300 mV (RMS)	$m = 30\%$; on pin 20	43	55	–	dB
			57	65	–	dB
Tuning stop detector						
Δf_{STOP-0}	detuning frequency for STOP-0 (pin 15)	see Fig.9 $V_{15} \geq 3.5$ V	–	–	+14.0	kHz
		$V_{15} \leq 0.3$ V	+22.0	–	–	kHz
Δf_{STOP-1}	detuning frequency for STOP-1 (pin 14)	see Fig.8 $V_{14} \geq 3.5$ V	–	–	-14.0	kHz
		$V_{14} \leq 0.3$ V	-22.0	–	–	kHz
V_{20}	dependence on input voltage for STOP-0 and STOP-1 (RMS value)	see Fig.7 $V_{14, 15} \geq 3.5$ V	250	–	–	μ V
		$V_{14, 15} \leq 0.3$ V	–	–	50	μ V
R_8	internal low-pass resistance of detune detector		12	25	50	k Ω
V_8	voltage on capacitor	$V_i \leq 5$ μ V (RMS) on input pin 20	–	2.2	–	V
Level detector ($I_2 = 0$)						
V_6	output voltage	$V_{20} \leq 5$ μ V (RMS)	0.1	–	1.1	V
		$V_{20} = 1$ mV (RMS)	3.0	–	4.2	V
Reference voltage source (pin 5)						
V_{ref}	reference output voltage	$I_5 = -1$ mA	3.3	3.7	4.1	V

IF amplifier/demodulator for
FM car radio receivers

TDA1593

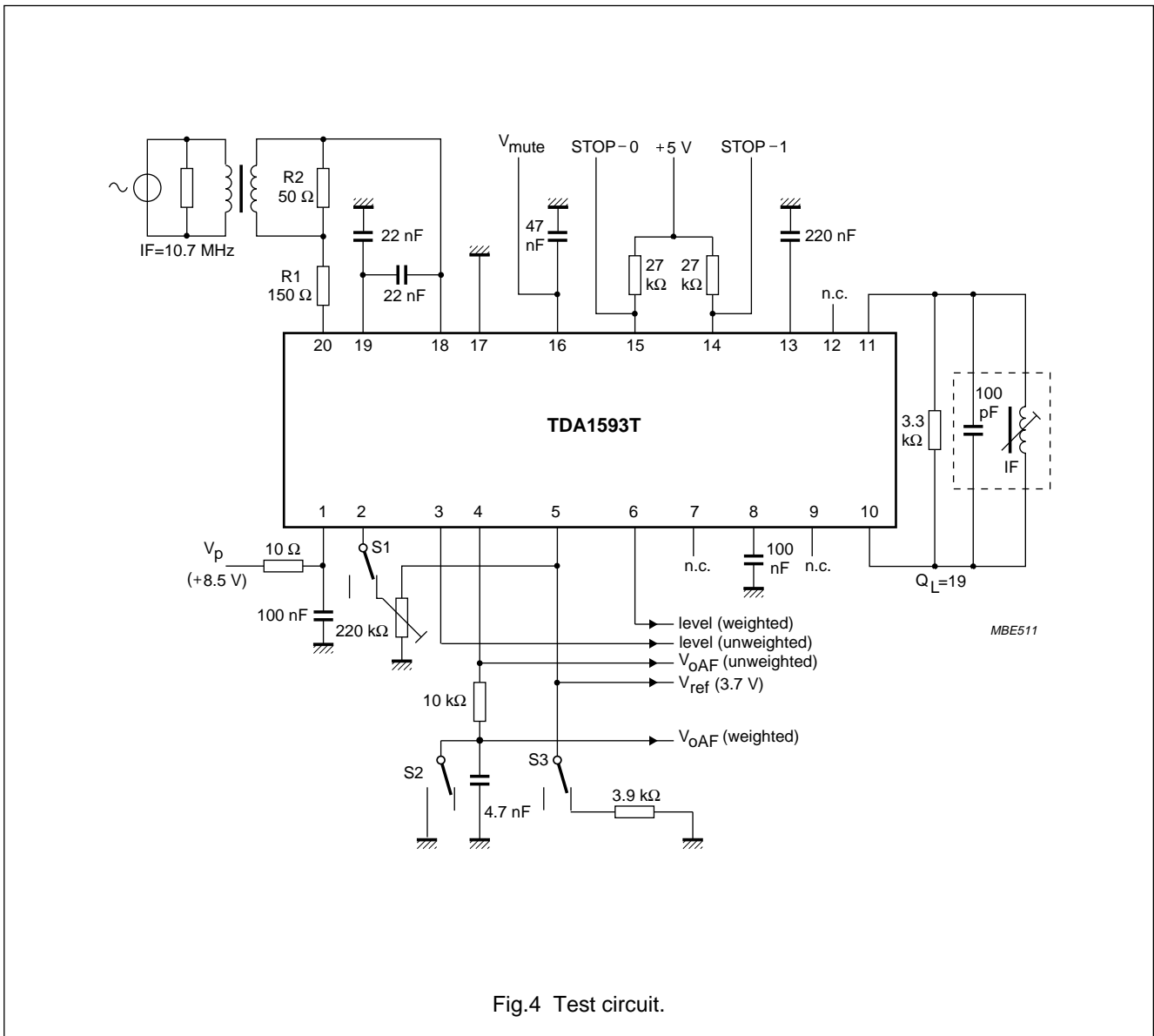
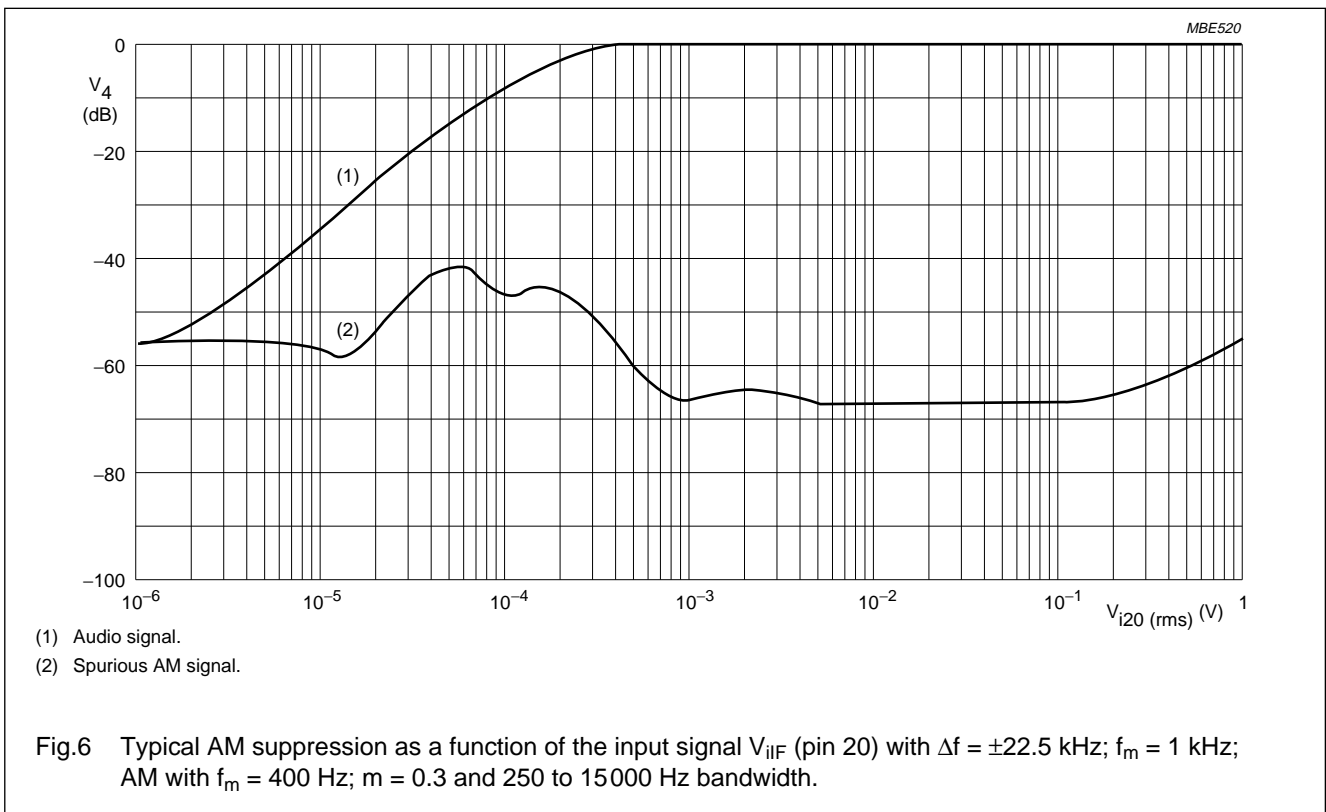
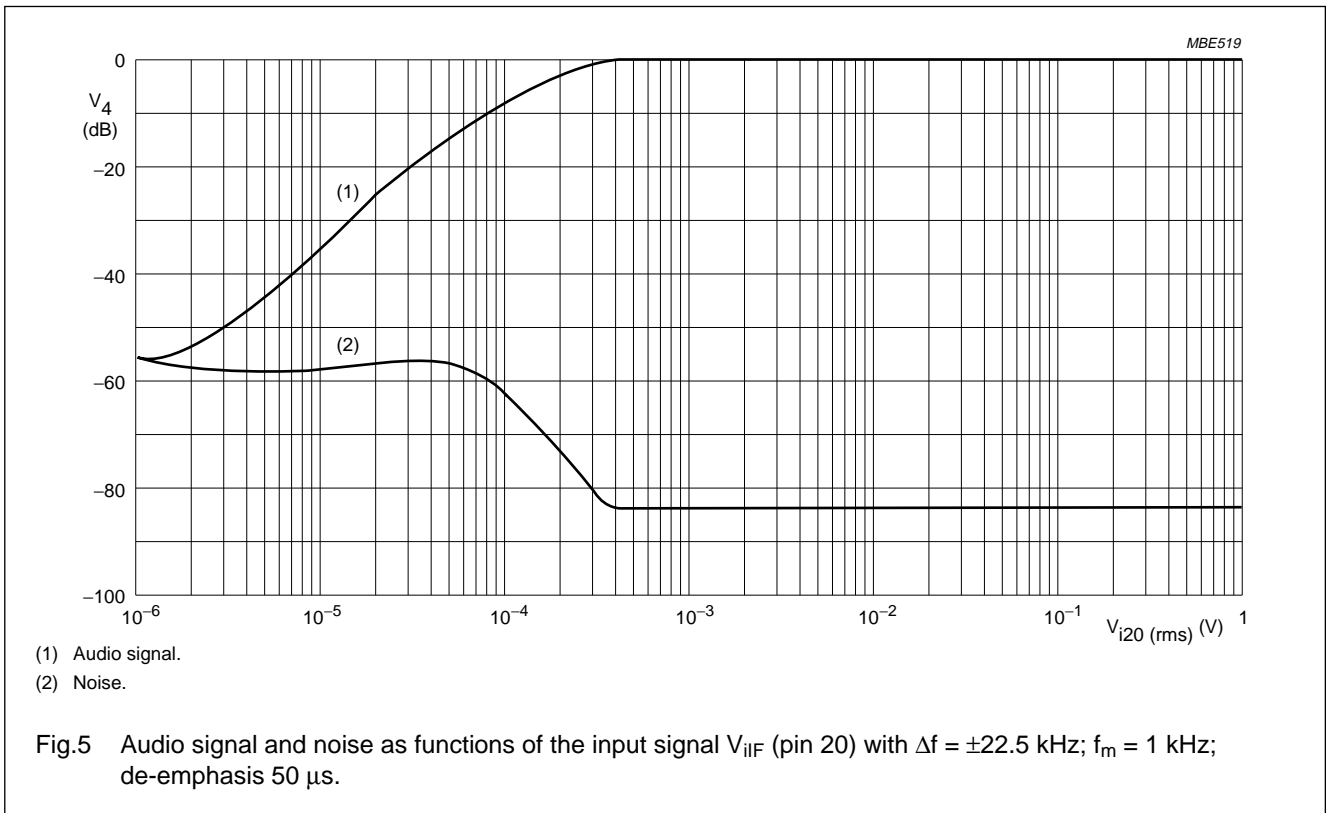

Fig.4 Test circuit.

IF amplifier/demodulator for
FM car radio receivers

TDA1593



IF amplifier/demodulator for
FM car radio receivers

TDA1593

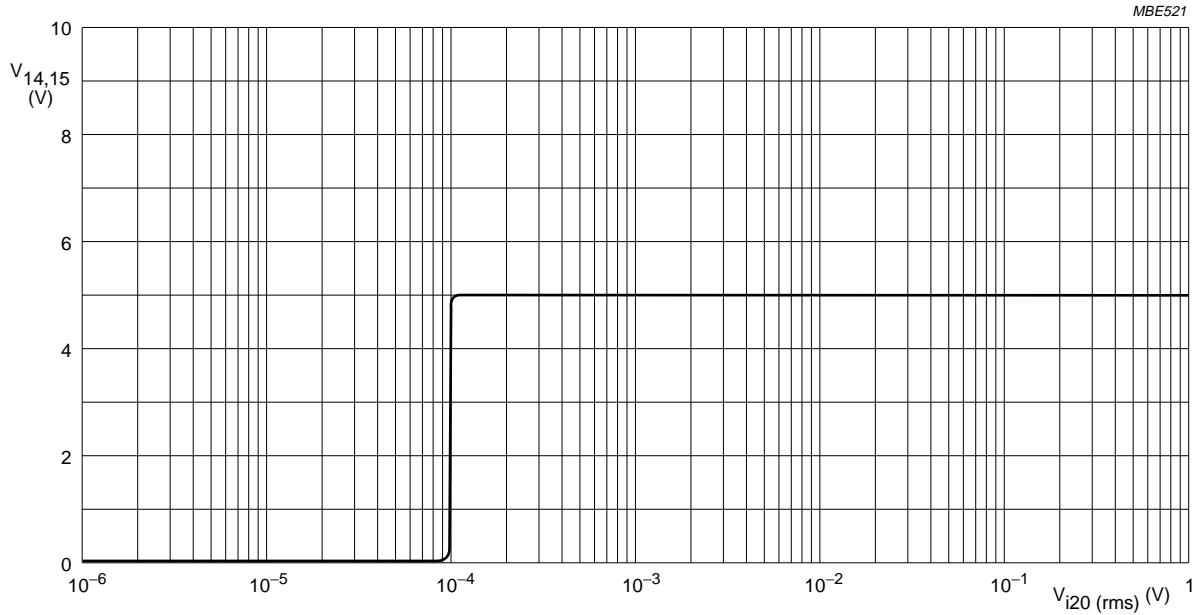

Fig.7 STOP-0 and STOP-1 output voltage dependent on input signal V_{iIF} (pin 20).

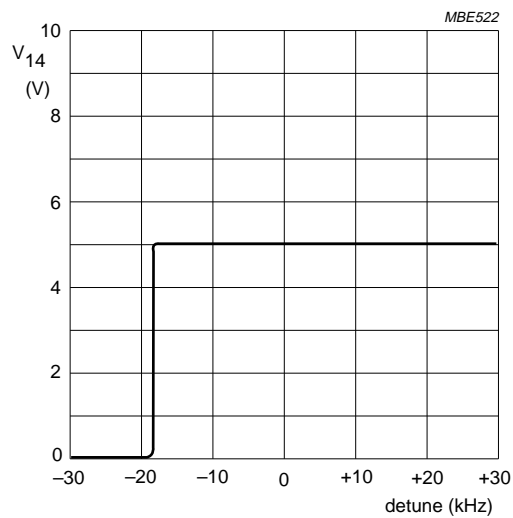

Fig.8 STOP-1 output voltage dependent on $V_{iIF} = 10$ mV (RMS) (pin 20).

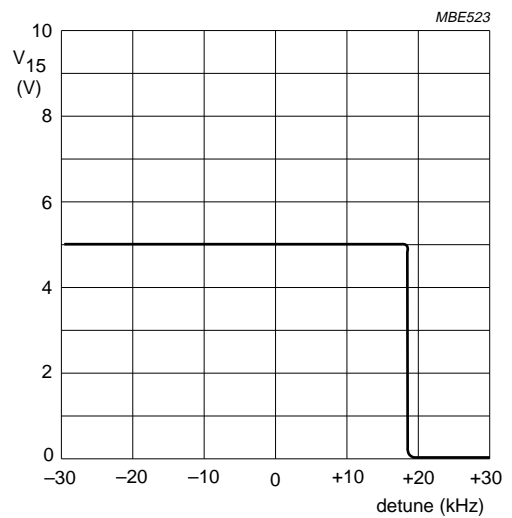
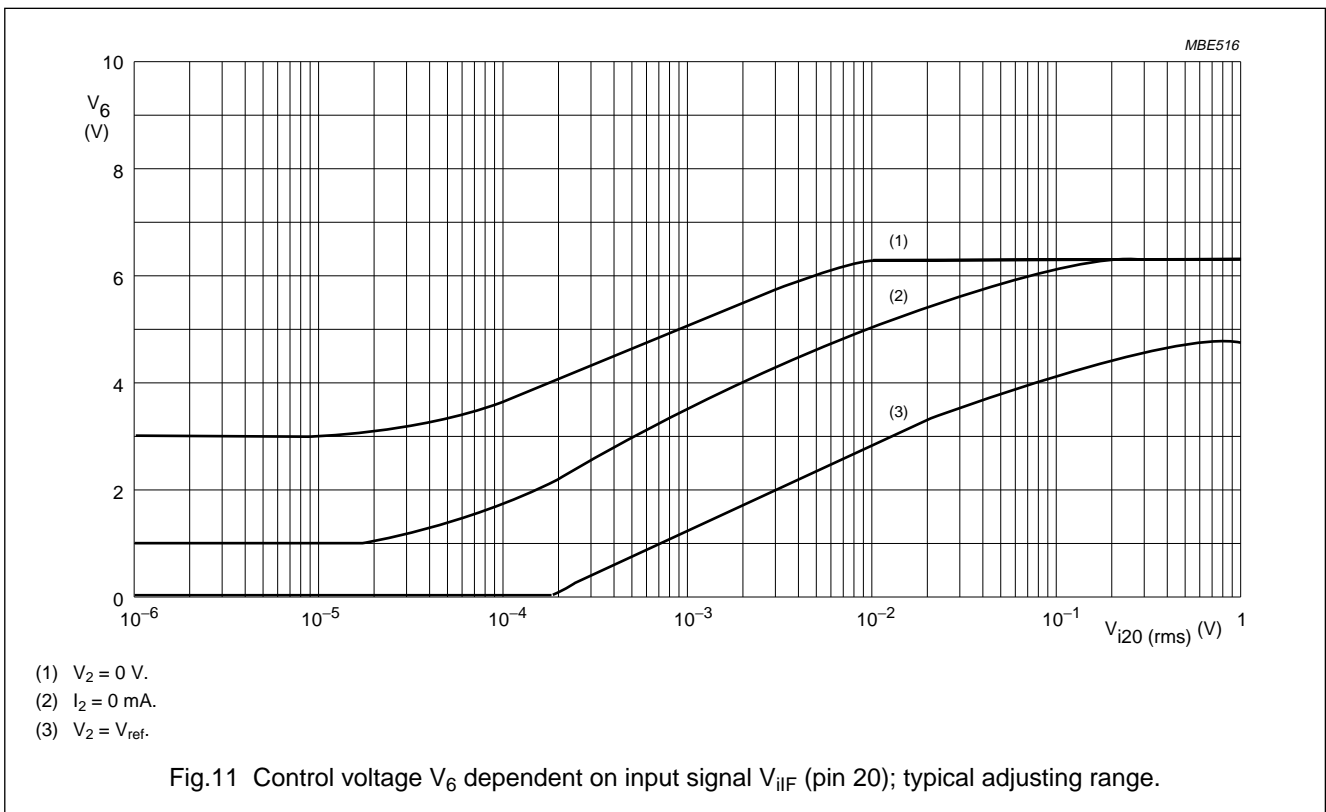
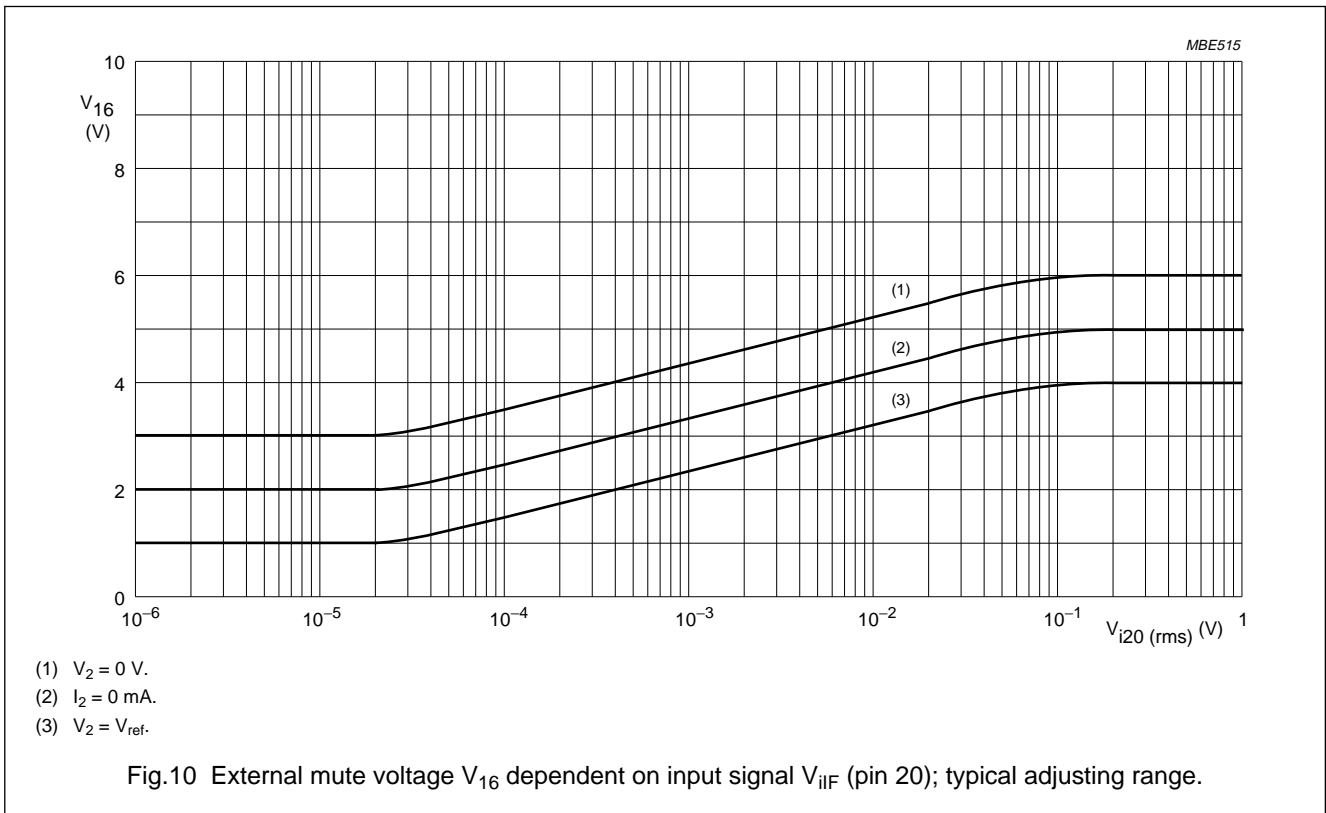

Fig.9 STOP-0 output voltage dependent on $V_{iIF} = 10$ mV (RMS) (pin 20).

IF amplifier/demodulator for
FM car radio receivers

TDA1593



IF amplifier/demodulator for
FM car radio receivers

TDA1593

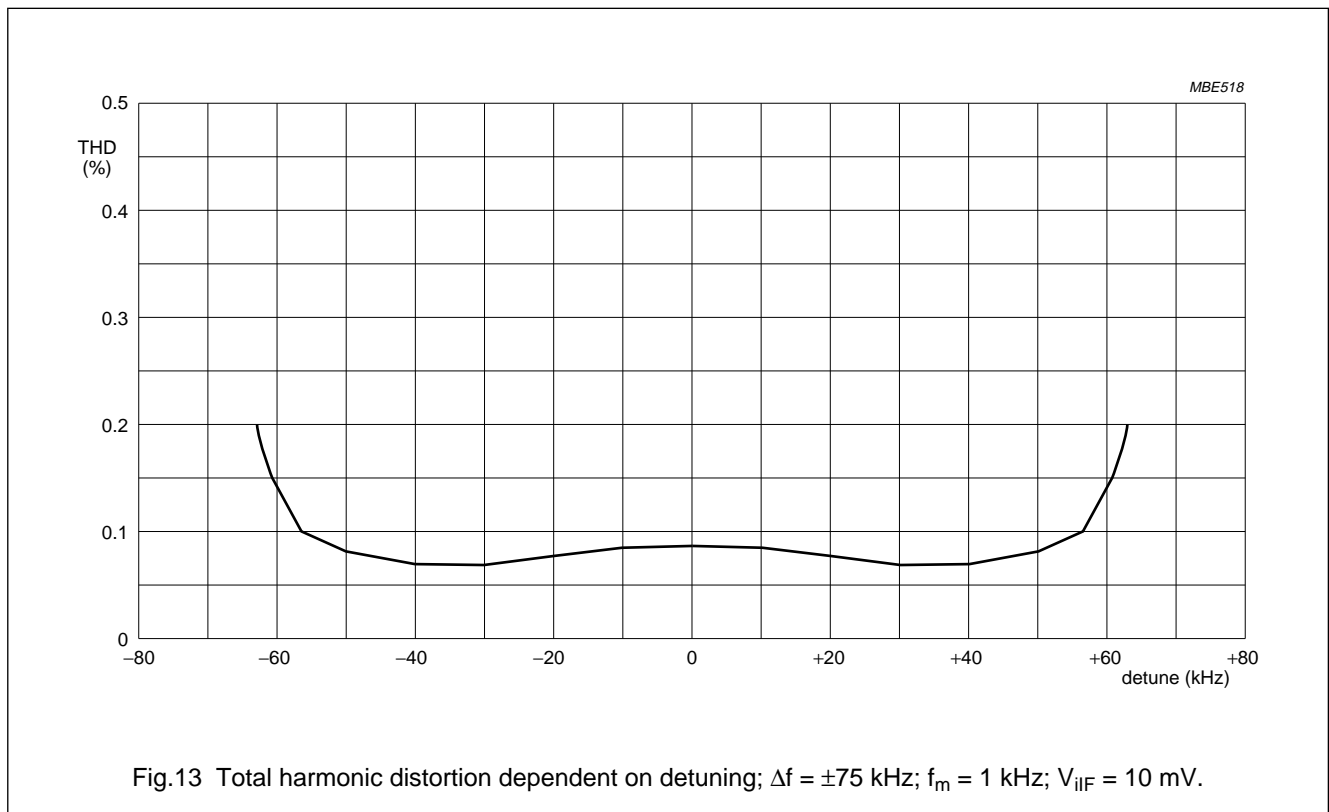
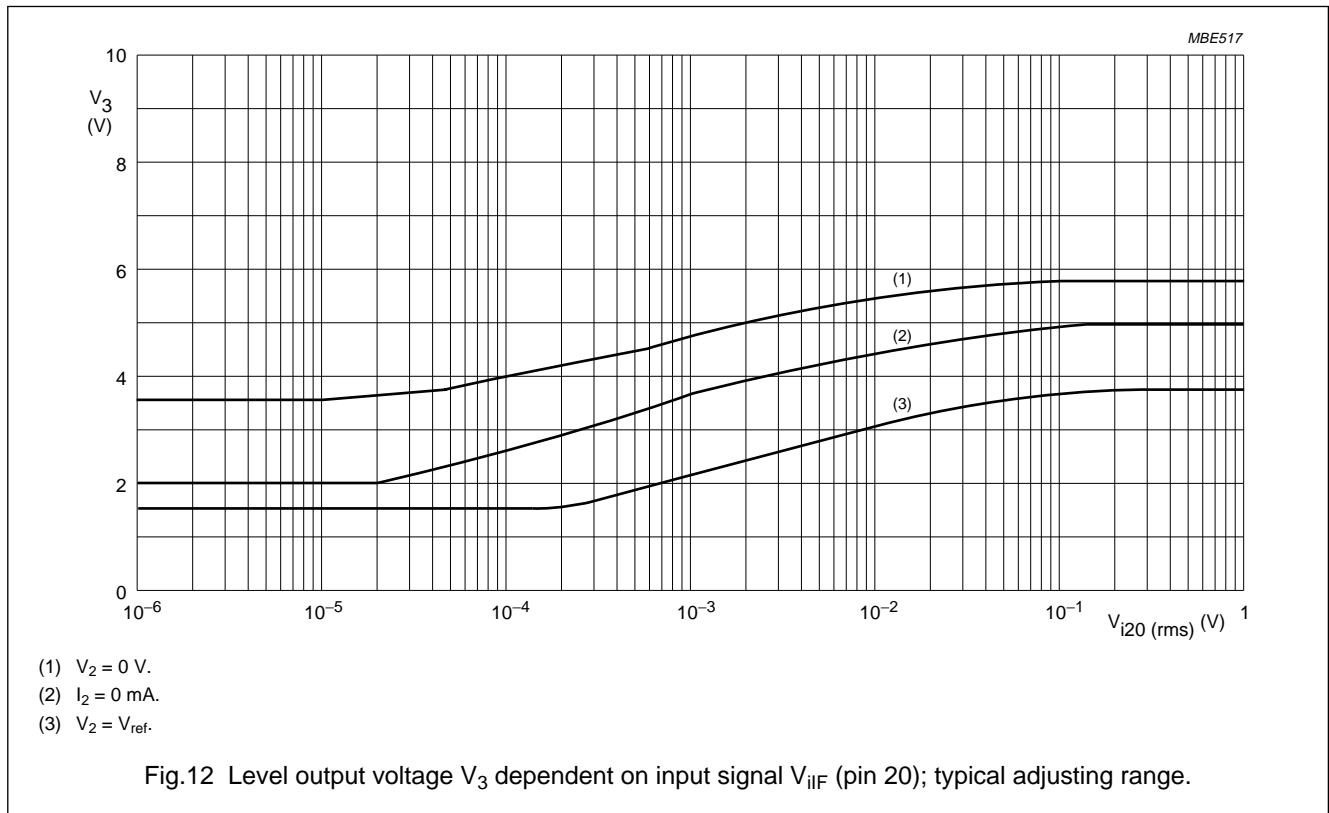

IF amplifier/demodulator for
FM car radio receivers

TDA1593

PACKAGE OUTLINES

DIP18: plastic dual in-line package; 18 leads (300 mil)

SOT102-1

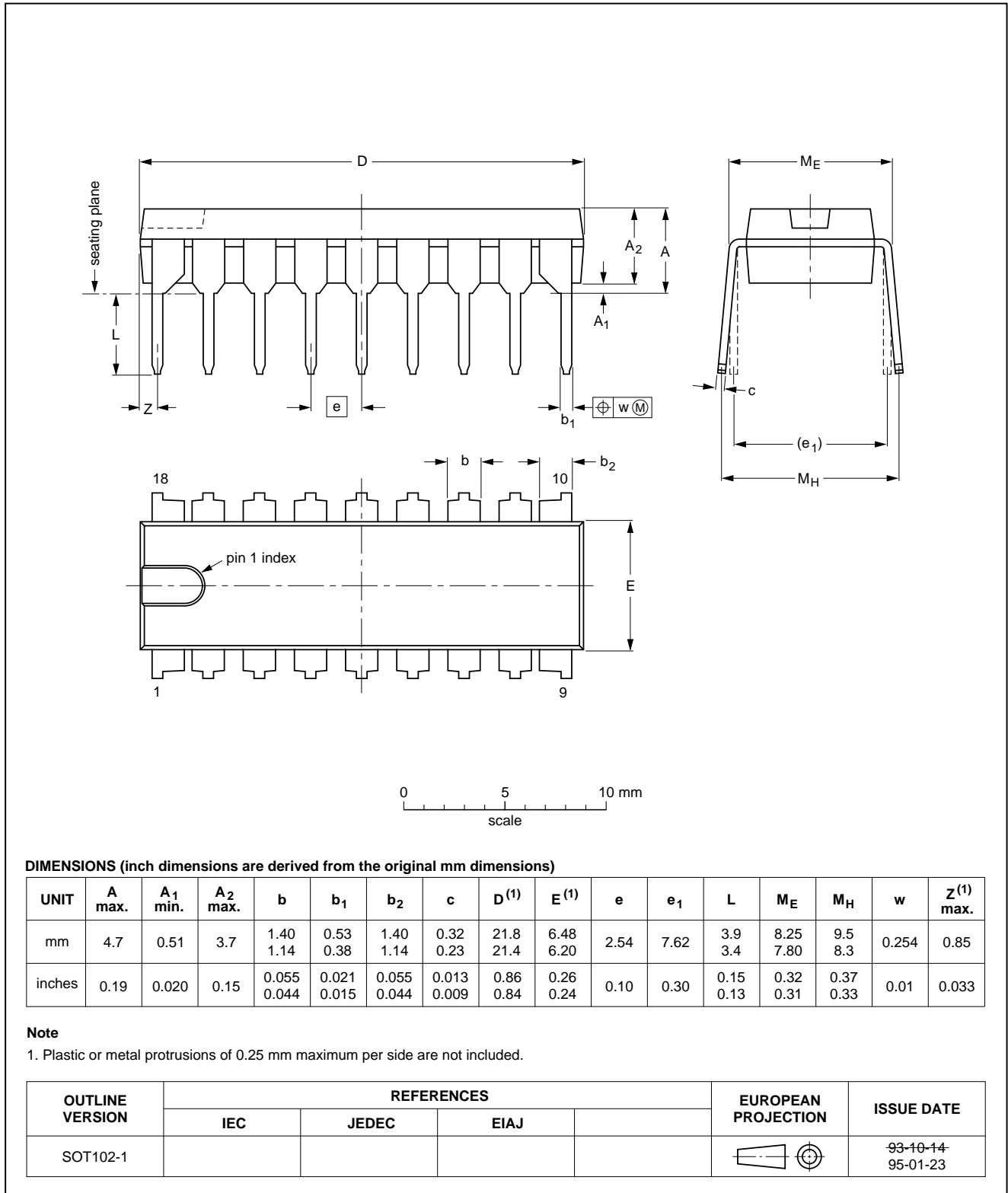

IF amplifier/demodulator for
FM car radio receivers

TDA1593

SO20: plastic small outline package; 20 leads; body width 7.5 mm

SOT163-1

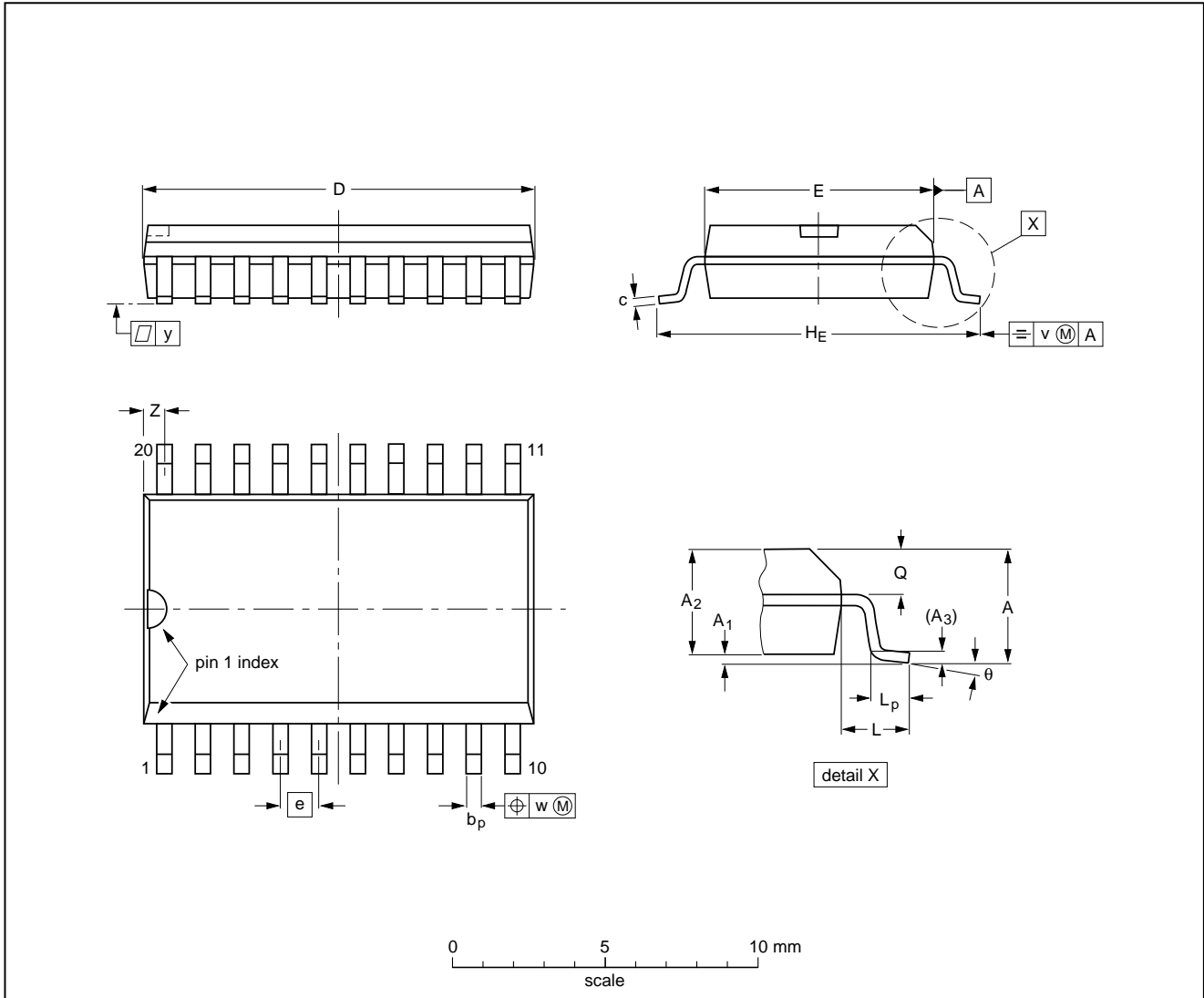

DIMENSIONS (inch dimensions are derived from the original mm dimensions)

UNIT	A max.	A ₁	A ₂	A ₃	b _p	c	D ⁽¹⁾	E ⁽¹⁾	e	H _E	L	L _p	Q	v	w	y	z ⁽¹⁾	θ
mm	2.65	0.30 0.10	2.45 2.25	0.25	0.49 0.36	0.32 0.23	13.0 12.6	7.6 7.4	1.27	10.65 10.00	1.4	1.1 0.4	1.1 1.0	0.25	0.25	0.1	0.9 0.4	8° 0°
inches	0.10	0.012 0.004	0.096 0.089	0.01	0.019 0.014	0.013 0.009	0.51 0.49	0.30 0.29	0.050	0.42 0.39	0.055	0.043 0.016	0.043 0.039	0.01	0.01	0.004	0.035 0.016	

Note

1. Plastic or metal protrusions of 0.15 mm maximum per side are not included.

OUTLINE VERSION	REFERENCES				EUROPEAN PROJECTION	ISSUE DATE
	IEC	JEDEC	EIAJ			
SOT163-1	075E04	MS-013AC				92-11-17 95-01-24

IF amplifier/demodulator for FM car radio receivers

TDA1593

SOLDERING

Plastic dual in-line packages

BY DIP OR WAVE

The maximum permissible temperature of the solder is 260 °C; this temperature must not be in contact with the joint for more than 5 s. The total contact time of successive solder waves must not exceed 5 s.

The device may be mounted up to the seating plane, but the temperature of the plastic body must not exceed the specified storage maximum. If the printed-circuit board has been pre-heated, forced cooling may be necessary immediately after soldering to keep the temperature within the permissible limit.

REPAIRING SOLDERED JOINTS

Apply a low voltage soldering iron below the seating plane (or not more than 2 mm above it). If its temperature is below 300 °C, it must not be in contact for more than 10 s; if between 300 and 400 °C, for not more than 5 s.

Plastic small outline packages

BY WAVE

During placement and before soldering, the component must be fixed with a droplet of adhesive. After curing the adhesive, the component can be soldered. The adhesive can be applied by screen printing, pin transfer or syringe dispensing.

Maximum permissible solder temperature is 260 °C, and maximum duration of package immersion in solder bath is 10 s, if allowed to cool to less than 150 °C within 6 s. Typical dwell time is 4 s at 250 °C.

A modified wave soldering technique is recommended using two solder waves (dual-wave), in which a turbulent wave with high upward pressure is followed by a smooth laminar wave. Using a mildly-activated flux eliminates the need for removal of corrosive residues in most applications.

BY SOLDER PASTE REFLOW

Reflow soldering requires the solder paste (a suspension of fine solder particles, flux and binding agent) to be applied to the substrate by screen printing, stencilling or pressure-syringe dispensing before device placement.

Several techniques exist for reflowing; for example, thermal conduction by heated belt, infrared, and vapour-phase reflow. Dwell times vary between 50 and 300 s according to method. Typical reflow temperatures range from 215 to 250 °C.

Preheating is necessary to dry the paste and evaporate the binding agent. Preheating duration: 45 min at 45 °C.

REPAIRING SOLDERED JOINTS (BY HAND-HELD SOLDERING IRON OR PULSE-HEATED SOLDER TOOL)

Fix the component by first soldering two, diagonally opposite, end pins. Apply the heating tool to the flat part of the pin only. Contact time must be limited to 10 s at up to 300 °C. When using proper tools, all other pins can be soldered in one operation within 2 to 5 s at between 270 and 320 °C. (Pulse-heated soldering is not recommended for SO packages.)

For pulse-heated solder tool (resistance) soldering of VSO packages, solder is applied to the substrate by dipping or by an extra thick tin/lead plating before package placement.

**IF amplifier/demodulator for
FM car radio receivers**

TDA1593**DEFINITIONS**

Data sheet status	
Objective specification	This data sheet contains target or goal specifications for product development.
Preliminary specification	This data sheet contains preliminary data; supplementary data may be published later.
Product specification	This data sheet contains final product specifications.
Limiting values	
Limiting values given are in accordance with the Absolute Maximum Rating System (IEC 134). Stress above one or more of the limiting values may cause permanent damage to the device. These are stress ratings only and operation of the device at these or at any other conditions above those given in the Characteristics sections of the specification is not implied. Exposure to limiting values for extended periods may affect device reliability.	
Application information	
Where application information is given, it is advisory and does not form part of the specification.	

LIFE SUPPORT APPLICATIONS

These products are not designed for use in life support appliances, devices, or systems where malfunction of these products can reasonably be expected to result in personal injury. Philips customers using or selling these products for use in such applications do so at their own risk and agree to fully indemnify Philips for any damages resulting from such improper use or sale.

NOTES

Philips Semiconductors – a worldwide company

Argentina: see South America

Australia: 34 Waterloo Road, NORTH RYDE, NSW 2113,
Tel. +61 2 9805 4455, Fax. +61 2 9805 4466

Austria: Computerstr. 6, A-1101 WIEN, P.O. Box 213,
Tel. +43 1 60 101, Fax. +43 1 60 101 1210

Belarus: Hotel Minsk Business Center, Bld. 3, r. 1211, Volodarski Str. 6,
220050 MINSK, Tel. +375 172 200 733, Fax. +375 172 200 773

Belgium: see The Netherlands

Brazil: see South America

Bulgaria: Philips Bulgaria Ltd., Energoproject, 15th floor,
51 James Bourchier Blvd., 1407 SOFIA,
Tel. +359 2 689 211, Fax. +359 2 689 102

Canada: PHILIPS SEMICONDUCTORS/COMPONENTS,
Tel. +1 800 234 7381

China/Hong Kong: 501 Hong Kong Industrial Technology Centre,
72 Tat Chee Avenue, Kowloon Tong, HONG KONG,
Tel. +852 2319 7888, Fax. +852 2319 7700

Colombia: see South America

Czech Republic: see Austria

Denmark: Prags Boulevard 80, PB 1919, DK-2300 COPENHAGEN S,
Tel. +45 32 88 2636, Fax. +45 31 57 1949

Finland: Sinikalliontie 3, FIN-02630 ESPOO,
Tel. +358 9 615800, Fax. +358 9 61580/xxx

France: 4 Rue du Port-aux-Vins, BP317, 92156 SURESNES Cedex,
Tel. +33 1 40 99 6161, Fax. +33 1 40 99 6427

Germany: Hammerbrookstraße 69, D-20097 HAMBURG,
Tel. +49 40 23 53 60, Fax. +49 40 23 536 300

Greece: No. 15, 25th March Street, GR 17778 TAVROS/ATHENS,
Tel. +30 1 4894 339/239, Fax. +30 1 4814 240

Hungary: see Austria

India: Philips INDIA Ltd, Shivsagar Estate, A Block, Dr. Annie Besant Rd.
Worli, MUMBAI 400 018, Tel. +91 22 4938 541, Fax. +91 22 4938 722

Indonesia: see Singapore

Ireland: Newstead, Clonskeagh, DUBLIN 14,
Tel. +353 1 7640 000, Fax. +353 1 7640 200

Israel: RAPAC Electronics, 7 Kehilat Saloniki St, TEL AVIV 61180,
Tel. +972 3 645 0444, Fax. +972 3 649 1007

Italy: PHILIPS SEMICONDUCTORS, Piazza IV Novembre 3,
20124 MILANO, Tel. +39 2 6752 2531, Fax. +39 2 6752 2557

Japan: Philips Bldg 13-37, Kohnan 2-chome, Minato-ku, TOKYO 108,
Tel. +81 3 3740 5130, Fax. +81 3 3740 5077

Korea: Philips House, 260-199 Itaewon-dong, Yongsan-ku, SEOUL,
Tel. +82 2 709 1412, Fax. +82 2 709 1415

Malaysia: No. 76 Jalan Universiti, 46200 PETALING JAYA, SELANGOR,
Tel. +60 3 750 5214, Fax. +60 3 757 4880

Mexico: 5900 Gateway East, Suite 200, EL PASO, TEXAS 79905,
Tel. +9-5 800 234 7381

Middle East: see Italy

Netherlands: Postbus 90050, 5600 PB EINDHOVEN, Bldg. VB,
Tel. +31 40 27 82785, Fax. +31 40 27 88399

New Zealand: 2 Wagener Place, C.P.O. Box 1041, AUCKLAND,
Tel. +64 9 849 4160, Fax. +64 9 849 7811

Norway: Box 1, Manglerud 0612, OSLO,
Tel. +47 22 74 8000, Fax. +47 22 74 8341

Philippines: Philips Semiconductors Philippines Inc.,
106 Valero St. Salcedo Village, P.O. Box 2108 MCC, MAKATI,
Metro MANILA, Tel. +63 2 816 6380, Fax. +63 2 817 3474

Poland: Ul. Lukiska 10, PL 04-123 WARSZAWA,
Tel. +48 22 612 2831, Fax. +48 22 612 2327

Portugal: see Spain

Romania: see Italy

Russia: Philips Russia, Ul. Usatcheva 35A, 119048 MOSCOW,
Tel. +7 095 247 9145, Fax. +7 095 247 9144

Singapore: Lorong 1, Toa Payoh, SINGAPORE 1231,
Tel. +65 350 2538, Fax. +65 251 6500

Slovakia: see Austria

Slovenia: see Italy

South Africa: S.A. PHILIPS Pty Ltd., 195-215 Main Road Martindale,
2092 JOHANNESBURG, P.O. Box 7430 Johannesburg 2000,
Tel. +27 11 470 5911, Fax. +27 11 470 5494

South America: Rua do Rocio 220, 5th floor, Suite 51,
04552-903 São Paulo, SÃO PAULO - SP, Brazil,
Tel. +55 11 821 2333, Fax. +55 11 829 1849

Spain: Balmes 22, 08007 BARCELONA,
Tel. +34 3 301 6312, Fax. +34 3 301 4107

Sweden: Kottbygatan 7, Akalla, S-16485 STOCKHOLM,
Tel. +46 8 632 2000, Fax. +46 8 632 2745

Switzerland: Allmendstrasse 140, CH-8027 ZÜRICH,
Tel. +41 1 488 2686, Fax. +41 1 481 7730

Taiwan: PHILIPS TAIWAN Ltd., 23-30F, 66,
Chung Hsiao West Road, Sec. 1, P.O. Box 22978,
TAIPEI 100, Tel. +886 2 382 4443, Fax. +886 2 382 4444

Thailand: PHILIPS ELECTRONICS (THAILAND) Ltd.,
209/2 Sanpavuth-Bangna Road Prakanong, BANGKOK 10260,
Tel. +66 2 745 4090, Fax. +66 2 398 0793

Turkey: Talatpasa Cad. No. 5, 80640 GÜLTEPE/ISTANBUL,
Tel. +90 212 279 2770, Fax. +90 212 282 6707

Ukraine: PHILIPS UKRAINE, 4 Patrice Lumumba str., Building B, Floor 7,
252042 KIEV, Tel. +380 44 264 2776, Fax. +380 44 268 0461

United Kingdom: Philips Semiconductors Ltd., 276 Bath Road, Hayes,
MIDDLESEX UB3 5BX, Tel. +44 181 730 5000, Fax. +44 181 754 8421

United States: 811 East Arques Avenue, SUNNYVALE, CA 94088-3409,
Tel. +1 800 234 7381

Uruguay: see South America

Vietnam: see Singapore

Yugoslavia: PHILIPS, Trg N. Pasica 5/v, 11000 BEOGRAD,
Tel. +381 11 625 344, Fax. +381 11 635 777

For all other countries apply to: Philips Semiconductors, Marketing & Sales Communications,
Building BE-p, P.O. Box 218, 5600 MD EINDHOVEN, The Netherlands, Fax. +31 40 27 24825

Internet: <http://www.semiconductors.philips.com>

© Philips Electronics N.V. 1996

SCA52

All rights are reserved. Reproduction in whole or in part is prohibited without the prior written consent of the copyright owner.

The information presented in this document does not form part of any quotation or contract, is believed to be accurate and reliable and may be changed without notice. No liability will be accepted by the publisher for any consequence of its use. Publication thereof does not convey nor imply any license under patent- or other industrial or intellectual property rights.

Printed in The Netherlands

517021/1200/03/pp20

Date of release: 1996 Oct 10

Document order number: 9397 750 01119

Let's make things better.

Philips
Semiconductors



PHILIPS