

The EF6809E is a revolutionary high performance 8-bit microprocessor which supports modern programming techniques such as position independence, reentrancy, and modular programming.

This third-generation addition to the 6800 Family has major architectural improvements which include additional registers, instructions, and addressing modes.

The basic instructions of any computer are greatly enhanced by the presence of powerful addressing modes. The EF6809E has the most complete set of addressing modes available on any 8-bit microprocessor today.

The EF6809E has hardware and software features which make it an ideal processor for higher level language execution or standard controller applications. External clock inputs are provided to allow synchronization with peripherals, systems, or other MPUs.

EF6800 COMPATIBLE

- Hardware – Interfaces with All 6800 Peripherals
- Software – Upward Source Code Compatible Instruction Set and Addressing Modes

ARCHITECTURAL FEATURES

- Two 16-Bit Index Registers
- Two 16-Bit Indexable Stack Pointers
- Two 8-Bit Accumulators can be Concatenated to Form One 16 Bit Accumulator
- Direct Page Register Allows Direct Addressing Throughout Memory

HARDWARE FEATURES

- External Clock Inputs, E and Q, Allow Synchronization
- TSC Input Controls Internal Bus Buffers
- LIC Indicates Opcode Fetch
- AVMA Allows Efficient Use of Common Resources in a Multiprocessor System
- BUSY is a Status Line for Multiprocessing
- Fast interrupt Request Input Stacks Only Condition Code Register and Program Counter
- Interrupt Acknowledge Output Allows Vectoring By Devices
- Sync Acknowledge Output Allows for Synchronization to External Event
- Single Bus-Cycle RESET
- Single 5-Volt Supply Operation
- NMI Inhibited After RESET Until After First Load of Stack Pointer
- Early Address Valid Allows Use With Slower Memories
- Early Write Data for Dynamic Memories

SOFTWARE FEATURES

- 10 Addressing Modes
 - 6800 Upward Compatible Addressing Modes
 - Direct Addressing Anywhere in Memory Map
 - Long Relative Branches
 - Program Counter Relative
 - True Indirect Addressing
 - Expanded Indexed Addressing
 - 0-, 5-, 8-, or 16-Bit Constant Offsets
 - 8- or 16-Bit Accumulator Offsets
 - Auto-Increment/Decrement by 1 or 2
 - Improved Stack Manipulation
 - 1464 Instruction with Unique Addressing Modes
 - 8 x 8 Unsigned Multiply
 - 16-Bit Arithmetic
 - Transfer/Exchange All Registers
 - Push/Pull Any Registers or Any Set of Registers
 - Load Effective Address

HMOS
(HIGH-DENSITY N-CHANNEL, SILICON-GATE)

**8-BIT
MICROPROCESSING
UNIT**

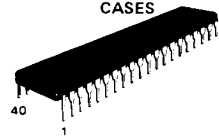

ALSO AVAILABLE
J SUFFIX CERDIP PACKAGE C SUFFIX CERAMIC PACKAGE

CB-521



FN SUFFIX
PLCC 44

PIN ASSIGNMENT

VSS	1	40	HALT
NMI	2	39	TSC
TRO	3	38	LIC
FIRO	4	37	RESET
BSP	5	36	AVMA
BA	6	35	Q
VCC	7	34	E
A0	8	33	BUSY
A1	9	32	R/W
A2	10	31	D0
A3	11	30	D1
A4	12	29	D2
A5	13	28	D3
A6	14	27	D4
A7	15	26	D5
A8	16	25	D6
A9	17	24	D7
A10	18	23	A15
A11	19	22	A14
A12	20	21	A13

MAXIMUM RATINGS

Rating	Symbol	Value	Unit
Supply Voltage	V _{CC}	-0.3 to +7.0	V
Input Voltage	V _{in}	-0.3 to +7.0	V
Operating Temperature Range EF6809E, EF68A09E, EF68B09E EF6809E, EF68A09E, EF68B09E, V suffix EF6809E, EF68A09E, M suffix	T _A	T _L to T _H 0 to +70 -40 to +85 -55 to +125	°C
Storage Temperature Range	T _{stg}	-55 to +150	°C

THERMAL CHARACTERISTICS

Characteristic	Symbol	Value	Unit
Thermal Resistance Ceramic Cerdp Plastic PLCC	θ _{JA}	50 60 100 100	°C/W

POWER CONSIDERATIONS

The average chip-junction temperature, T_J, in °C can be obtained from:

$$T_J = T_A + (P_D \cdot \theta_{JA}) \quad (1)$$

Where:

T_A = Ambient Temperature, °C

θ_{JA} = Package Thermal Resistance, Junction-to-Ambient, °C/W

P_D = P_{INT} + P_{PORT}

P_{INT} = I_{CC} × V_{CC}, Watts - Chip Internal Power

P_{PORT} = Port Power Dissipation, Watts - User Determined

For most applications P_{PORT} ≪ P_{INT} and can be neglected. P_{PORT} may become significant if the device is configured to drive Darlington bases or sink LED loads.

An approximate relationship between P_D and T_J (if P_{PORT} is neglected) is:

$$P_D = K + (T_J + 273)^\circ C \quad (2)$$

Solving equations 1 and 2 for K gives:

$$K = P_D \cdot (T_A + 273)^\circ C + \theta_{JA} \cdot P_D^2 \quad (3)$$

Where K is a constant pertaining to the particular part. K can be determined from equation 3 by measuring P_D (at equilibrium) for a known T_A. Using this value of K the values of P_D and T_J can be obtained by solving equations (1) and (2) iteratively for any value of T_A.

DC ELECTRICAL CHARACTERISTICS (V_{CC} = 5.0 V ± 5%, V_{SS} = 0 Vdc, T_A = T_L to T_H unless otherwise noted)

Characteristic	Symbol	Min	Typ	Max	Unit
Input High Voltage Logic, Q, RESET E	V _{IH} V _{IHR} V _{IHC}	V _{SS} + 2.0 V _{SS} + 4.0 V _{CC} - 0.75	- - -	V _{CC} V _{CC} V _{CC} + 0.3	V
Input Low Voltage Logic, RESET E Q	V _{IL} V _{ILC} V _{ILQ}	V _{SS} - 0.3 V _{SS} - 0.3 V _{SS} - 0.3	- - -	V _{SS} + 0.8 V _{SS} + 0.4 V _{SS} + 0.6	V
Input Leakage Current (V _{in} = 0 to 5.25 V, V _{CC} = max)	I _{in}	-	-	2.5 100	µA
dc Output High Voltage (I _{Load} = -205 µA, V _{CC} = min) (I _{Load} = -145 µA, V _{CC} = min) (I _{Load} = -100 µA, V _{CC} = min)	V _{OH}	V _{SS} + 2.4 V _{SS} + 2.4 V _{SS} + 2.4	- - -	- - -	V
dc Output Low Voltage (I _{Load} = 2.0 mA, V _{CC} = min)	V _{OL}	-	-	V _{SS} + 0.5	V
Internal Power Dissipation (Measured at T _A = 0°C in Steady State Operation)	P _{INT}	-	-	1.0	W
Capacitance (V _{in} = 0, T _A = 25°C, f = 1.0 MHz)	C _{in} C _{out}	- -	10 30	15 50	pF
Frequency of Operation (E and Q inputs)	f	0.1 0.1 0.1	- - -	1.0 1.5 2.0	MHz
Hi-Z (Off State) Input Current (V _{in} = 0.4 to 2.4 V, V _{CC} = max)	I _{TSI}	-	2.0	10 100	µA

* Capacitances are periodically tested rather than 100% tested

This device contains circuitry to protect the inputs against damage due to high static voltages or electric fields; however, it is advised that normal precautions be taken to avoid application of any voltage higher than maximum rated voltages to this high impedance circuit.

Reliability of operation is enhanced if unused inputs are tied to an appropriate logic voltage level (e.g., either V_{SS} or V_{CC}).

BUS TIMING CHARACTERISTICS (See Notes 1, 2, 3, and 4)

Ident. Number	Characteristics	Symbol	EF6809E		EF68A09E		EF68B09E		Unit
			Min	Max	Min	Max	Min	Max	
1	Cycle Time	t_{cyc}	10	10	0.667	10	0.5	10	μs
2	Pulse Width, E Low	PW_{EL}	450	9500	295	9500	210	9500	ns
3	Pulse Width, E High	PW_{EH}	450	9500	280	9500	220	9500	ns
4	Clock Rise and Fall Time	t_r, t_f	-	25	-	25	-	20	ns
5	Pulse Width, Q High	PW_{QH}	450	9500	280	9500	220	9500	ns
7	Delay Time, E to Q Rise	t_{EQ1}	200	-	130	-	100	-	ns
7A	Delay Time, Q High to E Rise	t_{EQ2}	200	-	130	-	100	-	ns
7B	Delay Time, E High to Q Fall	t_{EQ3}	200	-	130	-	100	-	ns
7C	Delay Time, Q High to E Fall	t_{EQ4}	200	-	130	-	100	-	ns
9	Address Hold Time	t_{AH}	20	-	20	-	20	-	ns
11	Address Delay Time from E Low (BA, BS, R, W)	t_{AD}	-	200	-	140	-	110	ns
17	Read Data Setup Time	t_{DSR}	80	-	60	-	40	-	ns
18	Read Data Hold Time	t_{DHR}	10	-	10	-	10	-	ns
20	Data Delay Time from Q	t_{DDQ}	-	200	-	140	-	110	ns
21	Write Data Hold Time	t_{DHW}	30	-	30	-	30	-	ns
29	Usable Access Time	t_{ACC}	695	-	440	-	330	-	ns
30	Control Delay Time	t_{CD}	-	300	-	250	-	200	ns
	Interrupts, HALT, RESET, and TSC Setup Time (Figures 6, 7, 8, 9, 12, and 13)	t_{PCS}	200	-	140	-	110	-	ns
	TSC Drive to Valid Logic Level (Figure 13)	t_{TSV}	-	210	-	150	-	120	ns
	TSC Release MOS Buffers to High Impedance (Figure 13)	t_{TSR}	-	200	-	140	-	110	ns
	TSC Hi-Z Delay Time (Figure 13)	t_{TSD}	-	120	-	85	-	80	ns
	Processor Control Rise and Fall Time (Figure 7)	t_{PCr}, t_{PCf}	-	100	-	100	-	100	ns

FIGURE 1 — READ/WRITE DATA TO MEMORY OR PERIPHERALS TIMING DIAGRAM

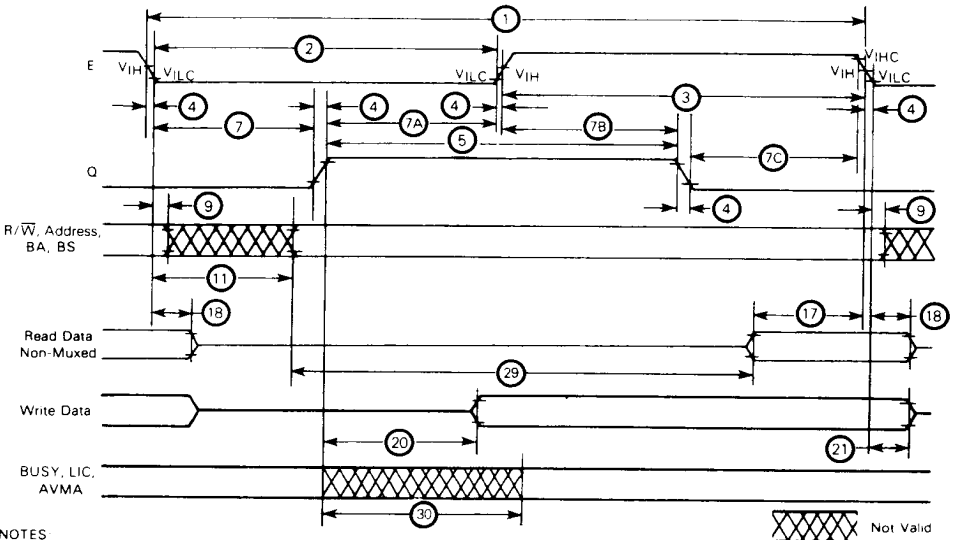

- NOTES:
- 1 Voltage levels shown are $V_{L} \leq 0.4 V$, $V_{H} \geq 2.4 V$, unless otherwise specified
 - 2 Measurement points shown are 0.8 V and 2.0 V, unless otherwise specified
 - 3 Hold time t_{H} for BA and BS is not specified
 - 4 Usable access time is computed by $1 - 4 - 11 \text{ max} - 17$

FIGURE 2 — EXPANDED BLOCK DIAGRAM

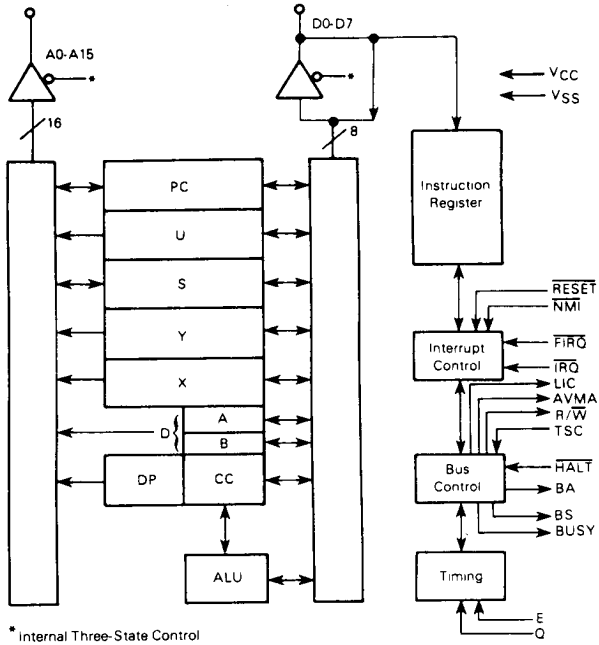

* Internal Three-State Control

PROGRAMMING MODEL

As shown in Figure 4, the EF6809E adds three registers to the set available in the EF6800. The added registers include a direct page register, the user stack pointer, and a second index register.

ACCUMULATORS (A, B, D)

The A and B registers are general purpose accumulators which are used for arithmetic calculations and manipulation of data.

Certain instructions concatenate the A and B registers to form a single 16-bit accumulator. This is referred to as the D register, and is formed with the A register as the most significant byte.

DIRECT PAGE REGISTER (DP)

The direct page register of the EF6809E serves to enhance the direct addressing mode. The content of this register appears at the higher address outputs (A8-A15) during direct addressing instruction execution. This allows the direct mode to be used at any place in memory, under program control. To ensure 6800 compatibility, all bits of this register are cleared during processor reset.

FIGURE 3 — BUS TIMING TEST LOAD

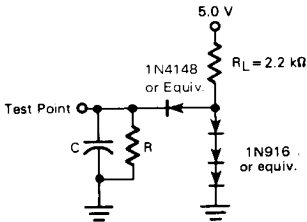

C = 30 pF for BA, BS, LIC, AVMA, BUSY
 130 pF for D0-D7
 90 pF for A0-A15, R/W

R = 11.7 kΩ for D0-D7
 16.5 kΩ for A0-A15, R/W
 24 kΩ for BA, BS, LIC, AVMA, BUSY

FIGURE 4 - PROGRAMMING MODEL OF THE MICROPROCESSING UNIT

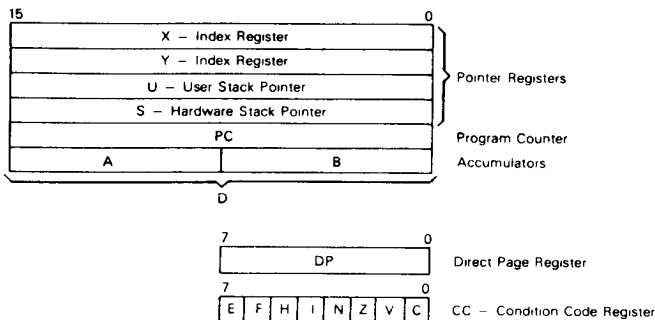
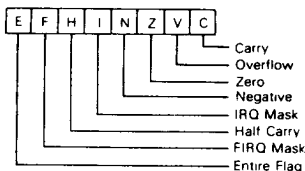

FIGURE 5 - CONDITION CODE REGISTER FORMAT



CONDITION CODE REGISTER DESCRIPTION

BIT 0 (C)

Bit 0 is the carry flag and is usually the carry from the binary ALU. C is also used to represent a "borrow" from subtract like instructions (CMP, NEG, SUB, SBC) and is the complement of the carry from the binary ALU.

BIT 1 (V)

Bit 1 is the overflow flag and is set to a one by an operation which causes a signed twos complement arithmetic overflow. This overflow is detected in an operation in which the carry from the MSB in the ALU does not match the carry from the MSB-1.

BIT 2 (Z)

Bit 2 is the zero flag and is set to a one if the result of the previous operation was identically zero.

INDEX REGISTERS (X, Y)

The index registers are used in indexed mode of addressing. The 16-bit address in this register takes part in the calculation of effective addresses. This address may be used to point to data directly or may be modified by an optional constant or register offset. During some indexed modes, the contents of the index register are incremented and decremented to point to the next item of tabular type data. All four pointer registers (X, Y, U, S) may be used as index registers.

STACK POINTER (U, S)

The hardware stack pointer (S) is used automatically by the processor during subroutine calls and interrupts. The user stack pointer (U) is controlled exclusively by the programmer. This allows arguments to be passed to and from subroutines with ease. The U register is frequently used as a stack marker. Both stack pointers have the same indexed mode addressing capabilities as the X and Y registers, but also support Push and Pull instructions. This allows the EF6809E to be used efficiently as a stack processor, greatly enhancing its ability to support higher level languages and modular programming.

NOTE

The stack pointers of the EF6809E point to the top of the stack in contrast to the EF6800 stack pointer, which pointed to the next free location on stack.

PROGRAM COUNTER

The program counter is used by the processor to point to the address of the next instruction to be executed by the processor. Relative addressing is provided allowing the program counter to be used like an index register in some situations.

CONDITION CODE REGISTER

The condition code register defines the state of the processor at any given time. See Figure 4.

BIT 3 (N)

Bit 3 is the negative flag, which contains exactly the value of the MSB of the result of the preceding operation. Thus, a negative twos complement result will leave N set to a one.

BIT 4 (I)

Bit 4 is the \overline{IRQ} mask bit. The processor will not recognize interrupts from the \overline{IRQ} line if this bit is set to a one. \overline{NMI} , \overline{FIRQ} , \overline{IRQ} , \overline{RESET} , and SW1 all set I to a one. SWI2 and SWI3 do not affect I.

BIT 5 (H)

Bit 5 is the half-carry bit, and is used to indicate a carry from bit 3 in the ALU as a result of an 8-bit addition only (ADC or ADD). This bit is used by the DAA instruction to perform a BCD decimal add adjust operation. The state of this flag is undefined in all subtract-like instructions.

BIT 6 (F)

Bit 6 is the \overline{FIRQ} mask bit. The processor will not recognize interrupts from the \overline{FIRQ} line if this bit is a one. \overline{NMI} , \overline{FIRQ} , SW1, and \overline{RESET} all set F to a one. \overline{IRQ} , SWI2, and SWI3 do not affect F.

BIT 7 (E)

Bit 7 is the entire flag, and when set to a one indicates that the complete machine state (all the registers) was stacked, as opposed to the subset state (PC and CC). The E bit of the stacked CC is used on a return from interrupt (RTI) to determine the extent of the unstacking. Therefore, the current E left in the condition code register represents past action.

PIN DESCRIPTIONS

POWER (V_{SS}, V_{CC})

Two pins are used to supply power to the part: V_{SS} is ground or 0 volts, while V_{CC} is +5.0 V ± 5%.

ADDRESS BUS (A0-A15)

Sixteen pins are used to output address information from the MPU onto the address bus. When the processor does not require the bus for a data transfer, it will output address FFFF₁₆, R/W = 1, and BS = 0, this is a "dummy access" or VMA cycle. All address bus drivers are made high-impedance when output bus available (BA) is high or when TSC is asserted. Each pin will drive one Schottky TTL load or four LSTTL loads and 90 pF.

DATA BUS (D0-D7)

These eight pins provide communication with the system bidirectional data bus. Each pin will drive one Schottky TTL load or four LSTTL loads and 130 pF.

READ/WRITE (R/W)

This signal indicates the direction of data transfer on the data bus. A low indicates that the MPU is writing data onto the data bus. R/W is made high impedance when BA is high or when TSC is asserted.

RESET

A low level on this Schmitt trigger input for greater than one bus cycle will reset the MPU, as shown in Figure 6. The

reset vectors are latched from locations FFFE₁₆ and FFFF₁₆ (Table 1) when interrupt acknowledge is true, ($\overline{BA} \cdot \overline{BS} = 1$). During initial power on, the reset line should be held low until the clock input signals are fully operational.

Because the EF6809E \overline{RESET} pin has a Schmitt-trigger input with a threshold voltage higher than that of standard peripherals, a simple R/C network may be used to reset the entire system. This higher threshold voltage ensures that all peripherals are out of the reset state before the processor.

HALT

A low level on this input pin will cause the MPU to stop running at the end of the present instruction and remain halted indefinitely without loss of data. When halted, the BA output is driven high indicating the buses are high impedance. BS is also high which indicates the processor is in the halt state. While halted, the MPU will not respond to external real-time requests (\overline{FIRQ} , \overline{IRQ}) although \overline{NMI} or \overline{RESET} will be latched for later response. During the halt state, Q and E should continue to run normally. A halted state ($\overline{BA} \cdot \overline{BS} = 1$) can be achieved by pulling HALT low while \overline{RESET} is still low. See Figure 7.

BUS AVAILABLE, BUS STATUS (BA, BS)

The bus available output is an indication of an internal control signal which makes the MOS buses of the MPU high impedance. When BA goes low, a dead cycle will elapse before the MPU acquires the bus. BA will not be asserted when TSC is active, thus allowing dead cycle consistency.

The bus status output signal, when decoded with BA, represents the MPU state (valid with leading edge of Q).

MPU State		MPU State Definition
BA	BS	
0	0	Normal (Running)
0	1	Interrupt or Reset Acknowledge
1	0	Sync Acknowledge
1	1	Halt Acknowledge

Interrupt Acknowledge is indicated during both cycles of a hardware vector fetch (\overline{RESET} , \overline{NMI} , \overline{FIRQ} , \overline{IRQ} , SW1, SWI2, SWI3). This signal, plus decoding of the lower four address lines, can provide the user with an indication of which interrupt level is being serviced and allow vectoring by device. See Table 1.

TABLE 1 — MEMORY MAP FOR INTERRUPT VECTORS

Memory Map For Vector Locations		Interrupt Vector Description
MS	LS	
FFFF	FFFF	\overline{RESET}
FFFF	FFFF	\overline{NMI}
FFFF	FFFF	SW1
FFF8	FFF9	\overline{IRQ}
FFF6	FFF7	\overline{FIRQ}
FFF4	FFF5	SWI2
FFF2	FFF3	SWI3
FFF0	FFF1	Reserved

FIGURE 6 - RESET TIMING

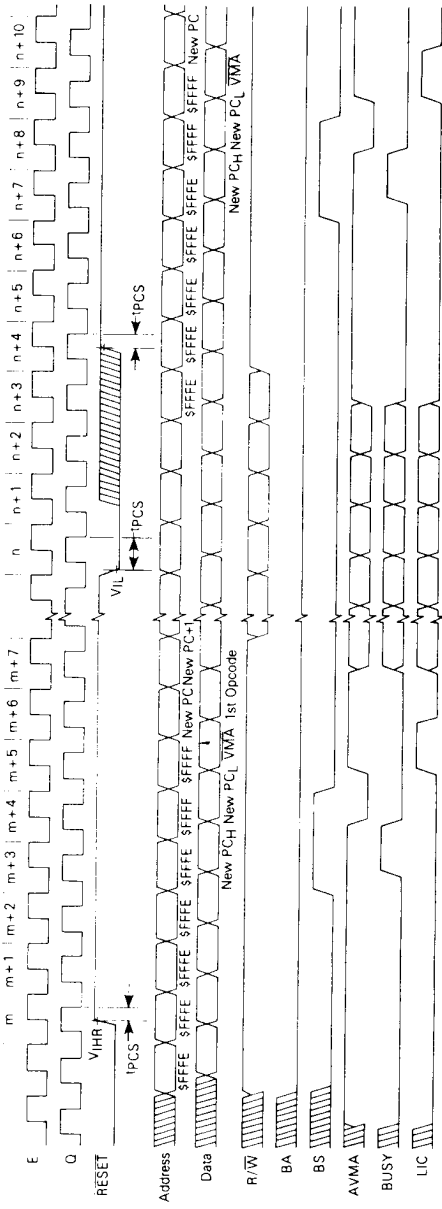

NOTE: Timing measurements are referenced to and from a low voltage of 0.8 volts and a high voltage of 2.0 volts, unless otherwise noted.

FIGURE 7 — HALT AND SINGLE INSTRUCTION EXECUTION TIMING FOR SYSTEM DEBUG

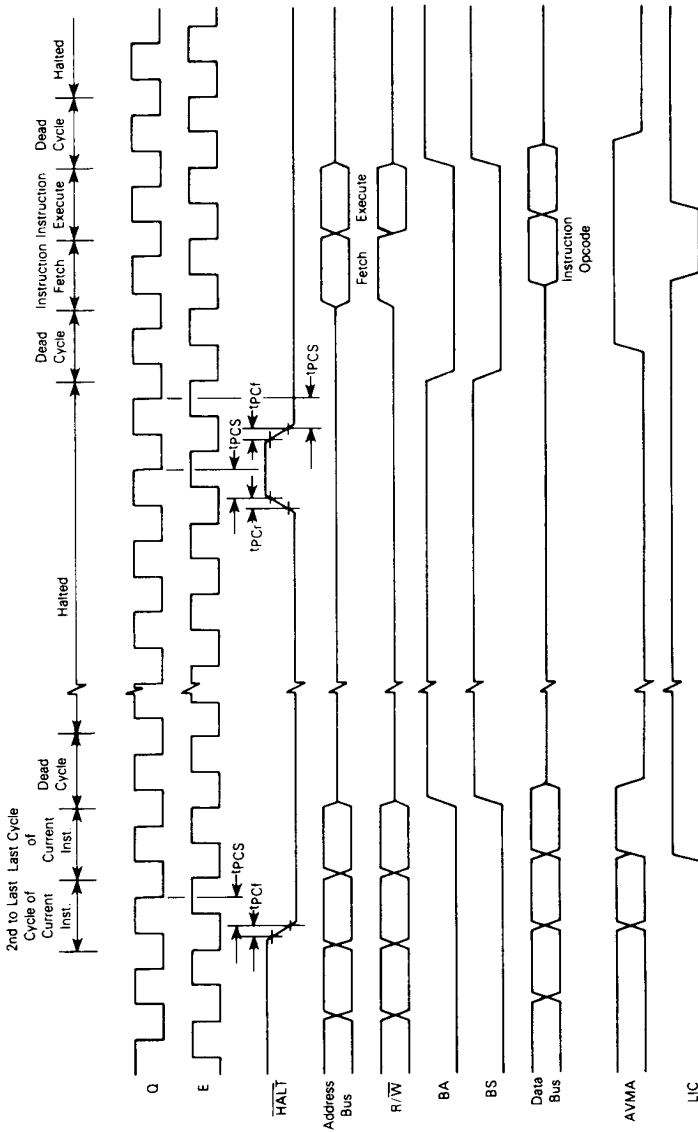

NOTE: Timing measurements are referenced to and from a low voltage of 0.8 volts and a high voltage of 2.0 volts, unless otherwise noted.

Sync Acknowledge is indicated while the MPU is waiting for external synchronization on an interrupt line

Halt Acknowledge is indicated when the EF6809E is in a halt condition

NON MASKABLE INTERRUPT ($\overline{\text{NMI}}$)*

A negative transition on this input requests that a non-maskable interrupt sequence be generated. A non-maskable interrupt cannot be inhibited by the program and also has a higher priority than $\overline{\text{FIRQ}}$, $\overline{\text{IRQ}}$, or software interrupts. During recognition of an NMI, the entire machine state is saved on the hardware stack. After reset, an NMI will not be recognized until the first program load of the hardware stack pointer (S). The pulse width of $\overline{\text{NMI}}$ low must be at least one E cycle. If the NMI input does not meet the minimum set up with respect to Q, the interrupt will not be recognized until the next cycle. See Figure 8.

FAST-INTERRUPT REQUEST ($\overline{\text{FIRQ}}$)*

A low level on this input pin will initiate a fast interrupt sequence, provided its mask bit (F) in the CC is clear. This sequence has priority over the standard interrupt request ($\overline{\text{IRQ}}$) and is fast in the sense that it stacks only the contents of the condition code register and the program counter. The interrupt service routine should clear the source of the interrupt before doing an RTI. See Figure 9.

INTERRUPT REQUEST ($\overline{\text{IRQ}}$)*

A low level input on this pin will initiate an interrupt request sequence provided the mask bit (I) in the CC is clear. Since $\overline{\text{IRQ}}$ stacks the entire machine state, it provides a slower response to interrupts than $\overline{\text{FIRQ}}$. $\overline{\text{IRQ}}$ also has a lower priority than $\overline{\text{FIRQ}}$. Again, the interrupt service routine should clear the source of the interrupt before doing an RTI. See Figure 8.

CLOCK INPUTS E, Q

E and Q are the clock signals required by the EF6809E. Q must lead E, that is, a transition on Q must be followed by a similar transition on E after a minimum delay. Addresses will be valid from the MPU, t_{AD} after the falling edge of E, and data will be latched from the bus by the falling edge of E. While the Q input is fully TTL compatible, the E input directly drives internal MOS circuitry and, thus, requires a high level above normal TTL levels. This approach minimizes clock skew inherent with an internal buffer. Refer to **BUS TIMING CHARACTERISTICS** for E and Q and to Figure 10 which shows a simple clock generator for the EF6809E.

BUSY

BUSY will be high for the read and modify cycles of a read-modify-write instruction and during the access of the first byte of a double-byte operation (e.g., LDX, STD, ADDD). BUSY is also high during the first byte of any indirect or other vector fetch (e.g., jump extended, SWI indirect, etc.).

In a multiprocessor system, BUSY indicates the need to

defer the rebarbitration of the next bus cycle to insure the integrity of the above operations. This difference provides the indivisible memory access required for a "test-and-set" primitive, using any one of several read-modify-write instructions.

BUSY does not become active during PSH or PUL operations. A typical read-modify-write instruction (ASL) is shown in Figure 11. Timing information is given in Figure 12. BUSY is valid t_{CD} after the rising edge of Q.

AVMA

AVMA is the advanced VMA signal and indicates that the MPU will use the bus in the following bus cycle. The predictive nature of the AVMA signal allows efficient shared-bus multiprocessor systems. AVMA is low when the MPU is in either a HALT or SYNC state. AVMA is valid t_{CD} after the rising edge of Q.

LIC

LIC (last instruction cycle) is high during the last cycle of every instruction, and its transition from high to low will indicate that the first byte of an opcode will be latched at the end of the present bus cycle. LIC will be high when the MPU is halted at the end of an instruction (i.e., not in CWA1 or RESET), in sync state, or while stacking during interrupts. LIC is valid t_{CD} after the rising edge of Q.

TSC

TSC (three-state control) will cause MOS address, data, and R/W buffers to assume a high-impedance state. The control signals (BA, BS, BUSY, AVMA, and LIC) will not go to the high-impedance state. TSC is intended to allow a single bus to be shared with other bus masters (processors or DMA controllers).

While E is low, TSC controls the address buffers and R/W directly. The data bus buffers during a write operation are in a high-impedance state until Q rises at which time, if TSC is true, they will remain in a high-impedance state. If TSC is held beyond the rising edge of E, then it will be internally latched, keeping the bus drivers in a high-impedance state for the remainder of the bus cycle. See Figure 13.

MPU OPERATION

During normal operation, the MPU fetches an instruction from memory and then executes the requested function. This sequence begins after RESET and is repeated indefinitely unless altered by a special instruction or hardware occurrence. Software instructions that alter normal MPU operation are: SWI, SWI2, SWI3, CWA1, RTI, and SYNC. An interrupt or HALT input can also alter the normal execution of instructions. Figure 14 is the flowchart for the EF6809E.

* NMI, $\overline{\text{FIRQ}}$, and $\overline{\text{IRQ}}$ requests are sampled on the falling edge of Q. One cycle is required for synchronization before these interrupts are recognized. The pending interrupt(s) will not be serviced until completion of the current instruction unless a SYNC or CWA1 condition is present. If $\overline{\text{IRQ}}$ and $\overline{\text{FIRQ}}$ do not remain low until completion of the current instruction, they may not be recognized. However, NMI is latched and need only remain low for one cycle. No interrupts are recognized or latched between the falling edge of RESET and the rising edge of BS indicating RESET acknowledge. See RESET sequence in the MPU flowchart in Figure 14.

FIGURE 8 - IRQ AND NMI INTERRUPT TIMING

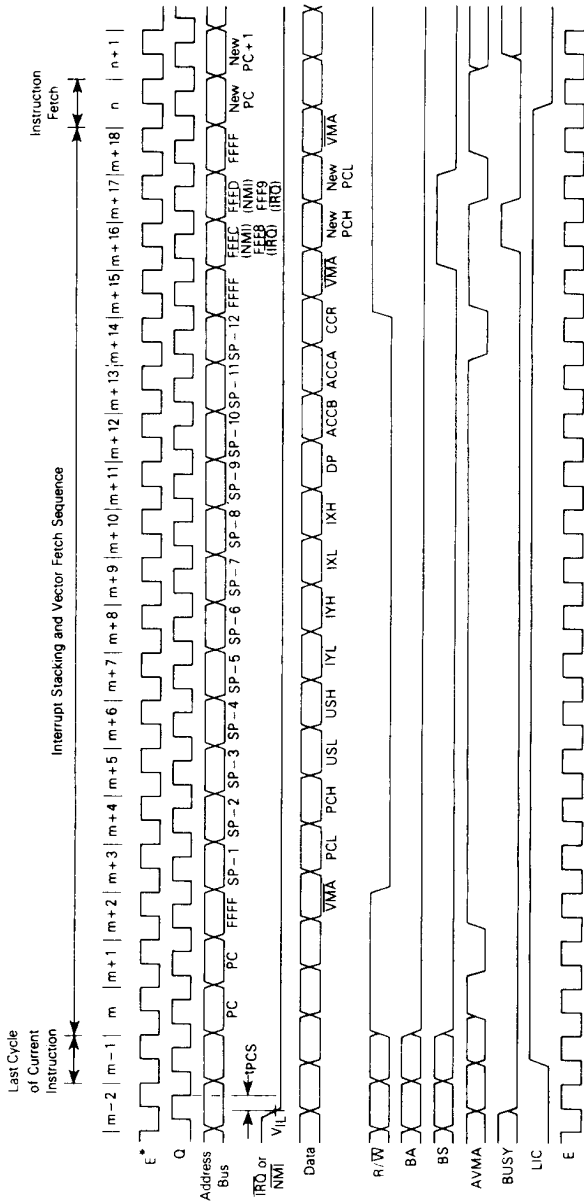

* E clock shown for reference only

NOTE: Timing measurements are referenced to and from a low voltage of 0.8 volts and a high voltage of 2.0 volts, unless otherwise noted.

FIGURE 9 — FIRO INTERRUPT TIMING

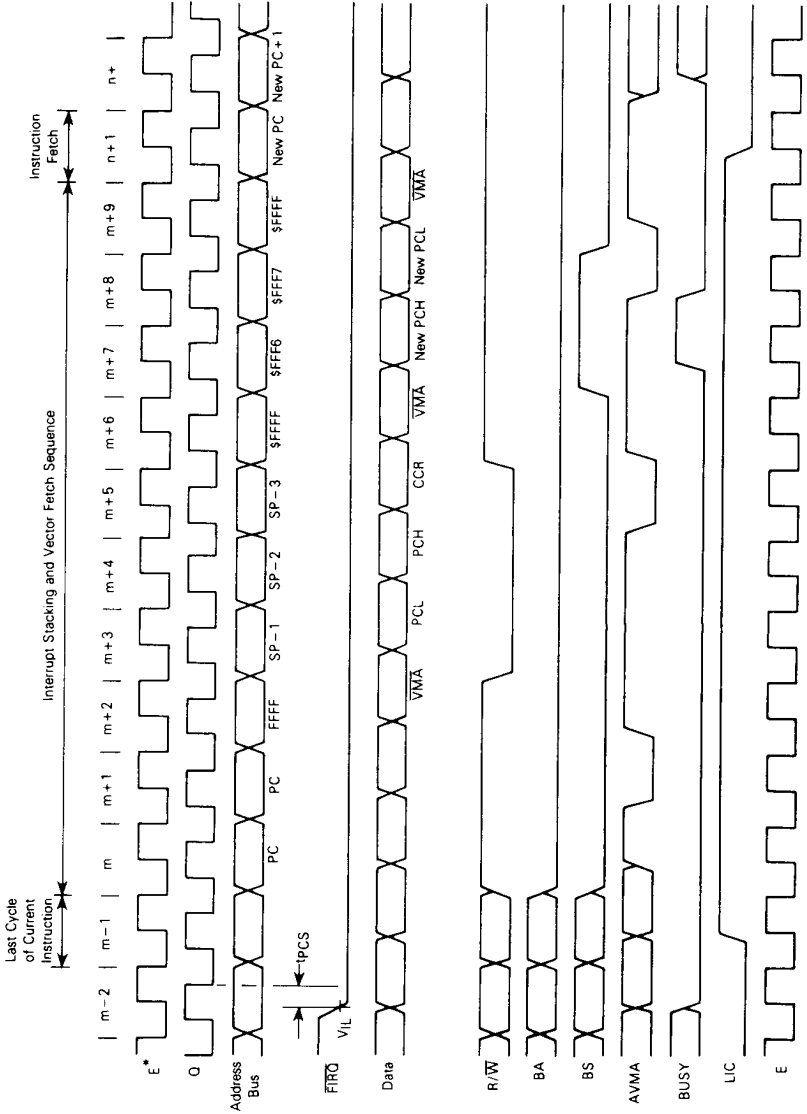

* E clock shown for reference only.

NOTE: Timing measurements are referenced to and from a low voltage of 0.8 volts and a high voltage of 2.0 volts, unless otherwise noted.

FIGURE 10 - CLOCK GENERATOR

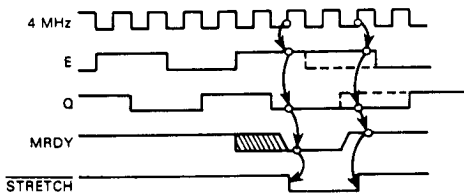
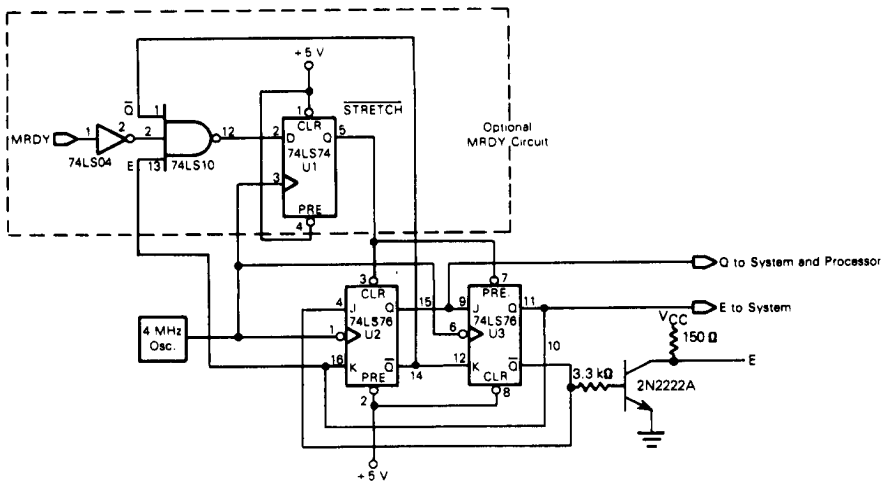

NOTE: If optional circuit is not included the CLR and PRE inputs of U2 and U3 must be tied high.

FIGURE 11 - READ-MODIFY-WRITE INSTRUCTION EXAMPLE (ASL EXTENDED INDIRECT)

Memory Location	Memory Contents	Contents Description
PC → \$0200	\$68	ASL Indexed Opcode
\$0201	\$9F	Extended indirect Postbyte
\$0202	\$63	Indirect Address Hi-Byte
\$0203	\$00	Indirect Address Lo-Byte
\$0204		Next Main Instruction
\$6300	\$E3	Effective Address Hi-Byte
\$6301	\$D6	Effective Address Lo-Byte
\$E306	\$5C	Target Data

FIGURE 12 — BUSY TIMING

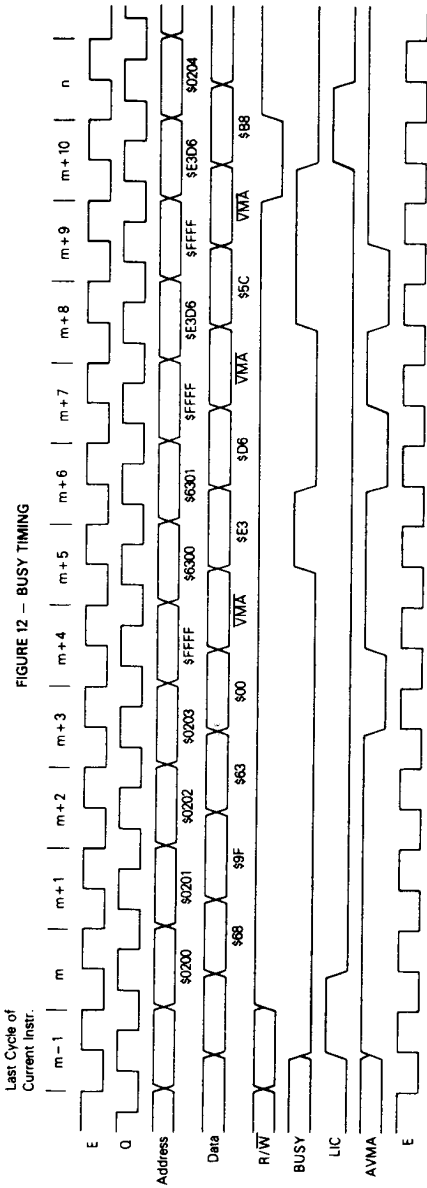
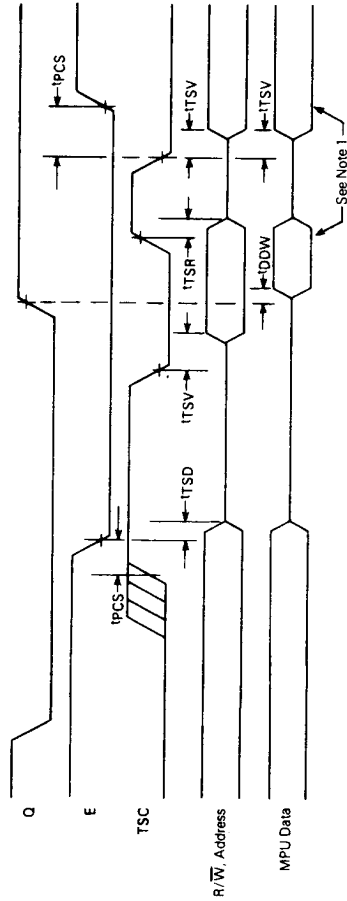

FIGURE 13 — TSC TIMING



NOTES:

1. Data will be asserted by the MPU only during the interval while $\overline{R/\overline{W}}$ is low and \overline{E} or \overline{Q} is high. A composite bus cycle is shown to give most cases of timing.
2. Timing measurements are referenced to and from a low voltage of 0.8 volts and a high voltage of 2.0 volts, unless otherwise noted.

FIGURE 14 — FLOWCHART FOR EF6809E INSTRUCTIONS

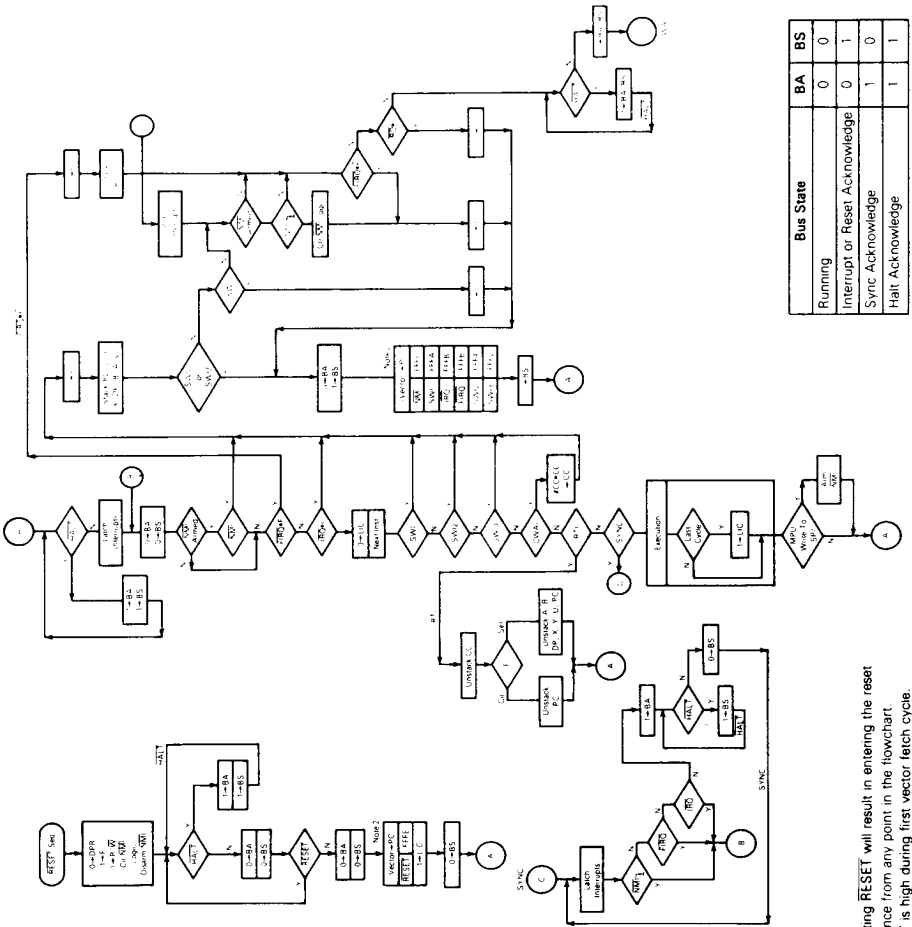

NOTES: 1. Asserting RESET will result in entering the reset sequence from any point in the flowchart.
 2. BUSY is high during first vector fetch cycle.

The basic instructions of any computer are greatly enhanced by the presence of powerful addressing modes. The EF6809E has the most complete set of addressing modes available on any microcomputer today. For example, the EF6809E has 59 basic instructions, however, it recognizes 1464 different variations of instructions and addressing modes. The addressing modes support modern programming techniques. The following addressing modes are available on the EF6809E :

- Inherent (Includes Accumulator)
- Immediate
- Extended
- Extended Indirect
- Direct
- Register
- Indexed
 - Zero-Offset
 - Constant Offset
 - Accumulator Offset
 - Auto Increment/Decrement
 - Indexed Indirect
- Relative
 - Short/Long Relative Branching
 - Program Counter Relative Addressing

INHERENT (INCLUDES ACCUMULATOR)

In this addressing mode, the opcode of the instruction contains all the address information necessary. Examples of inherent addressing are: ABX, DAA, SWI, ASRA, and CLRB.

IMMEDIATE ADDRESSING

In immediate addressing, the effective address of the data is the location immediately following the opcode (i.e., the data to be used in the instruction immediately following the opcode of the instruction). The EF6809E uses both 8- and 16-bit immediate values depending on the size of argument specified by the opcode. Examples of instructions with immediate addressing are:

```
LDA  #S20
LDX  #SF000
LDY  #CAT
```

NOTE

signifies immediate addressing, \$ signifies hexadecimal value to the EF6809 assembler.

EXTENDED ADDRESSING

In extended addressing, the contents of the two bytes immediately following the opcode fully specify the 16-bit effective address used by the instruction. Note that the address generated by an extended instruction defines an absolute address and is not position independent. Examples of extended addressing include:

```
LDA  CAT
STX  MOUSE
LDD  $2000
```

EXTENDED INDIRECT

As a special case of indexed addressing (discussed below), one level of indirection may be added to extended addressing. In extended indirect, the two bytes following the postbyte of an indexed instruction contain the address of the data.

```
LDA  [CAT]
LDX  [$FFFE]
STU  {DOG}
```

DIRECT ADDRESSING

Direct addressing is similar to extended addressing except that only one byte of address follows the opcode. This byte specifies the lower eight bits of the address to be used. The upper eight bits of the address are supplied by the direct page register. Since only one byte of address is required in direct addressing, this mode requires less memory and executes faster than extended addressing. Of course, only 256 locations (one page) can be accessed without redefining the contents of the DP register. Since the DP register is set to \$00 on reset, direct addressing on the EF6809E is upward compatible with direct addressing on the 6800. Indirection is not allowed in direct addressing. Some examples of direct addressing are:

```
LDA  where DP = $00
LDB  where DP = $10
LDD  < CAT
```

NOTE

< is an assembler directive which forces direct addressing

REGISTER ADDRESSING

Some opcodes are followed by a byte that defines a register or set of registers to be used by the instruction. This is called a postbyte. Some examples of register addressing are:

```
TFR  X, Y      Transfers X into Y
EXG  A, B      Exchanges A with B
PSHS A, B, X, Y Push Y, X, B and A onto S
                    stack
PULU X, Y, D   Pull D, X, and Y from U
                    stack
```

INDEXED ADDRESSING

In all indexed addressing, one of the pointer registers (X, Y, U, S, and sometimes PC) is used in a calculation of the effective address of the operand to be used by the instruction. Five basic types of indexing are available and are discussed below. The postbyte of an indexed instruction specifies the basic type and variation of the addressing mode, as well as the pointer register to be used. Figure 15 lists the legal formats for the postbyte. Table 2 gives the assembler form and the number of cycles and bytes added to the basic values for indexed addressing for each variation.

FIGURE 15 — INDEXED ADDRESSING POSTBYTE REGISTER BIT ASSIGNMENTS

Post-Byte Register Bit								Indexed Addressing Mode
7	6	5	4	3	2	1	0	
0	R	R	d	d	d	d	d	EA = ,R + 5 Bit Offset
1	R	R	0	0	0	0	0	,R+
1	R	R	i	0	0	0	1	,R++
1	R	R	0	0	0	1	0	,-R
1	R	R	i	0	0	1	1	,--R
1	R	R	i	0	1	0	0	EA = ,R+0 Offset
1	R	R	i	0	1	0	1	EA = ,R + ACCB Offset
1	R	R	i	0	1	1	0	EA = ,R + ACCA Offset
1	R	R	i	1	0	0	0	EA = ,R + 8 Bit Offset
1	R	R	i	1	0	0	1	EA = ,R + 16 Bit Offset
1	R	R	i	1	0	1	1	EA = ,R + D Offset
1	x	x	i	1	1	0	0	EA = ,PC + 8 Bit Offset
1	x	x	i	1	1	0	1	EA = ,PC + 16 Bit Offset
1	R	R	i	1	1	1	1	EA = (.Address)

Addressing Mode Field
 Indirect Field
 (Sign Bit when b7 = 0)

Register Field: RR
 00 = X
 01 = Y
 10 = U
 11 = S

x = Don't Care
 d = Offset Bit
 0 = Not Indirect
 i = Indirect

ZERO-OFFSET INDEXED — In this mode, the selected pointer register contains the effective address of the data to be used by the instruction. This is the fastest indexing mode.

Examples are:
 LDD O, X
 LDA ,S

CONSTANT OFFSET INDEXED — In this mode, two complement offset and the contents of one of the pointer registers are added to form the effective address of the operand. The pointer register's initial content is unchanged by the addition.

- Three sizes of offset are available:
 5-bit (-16 to +15)
 8-bit (-128 to +127)
 16-bit (-32768 to +32767)

The two complement 5-bit offset is included in the post-byte and, therefore, is most efficient in use of bytes and cycles. The two complement 8-bit offset is contained in a single byte following the postbyte. The two complement 16-bit offset is in the two bytes following the postbyte. In most cases the programmer need not be concerned with the size of this offset since the assembler will select the optimal size automatically.

Examples of constant-offset indexing are:
 LDA 23,X
 LDY -2,S
 LDY 300,X
 LDU CAT,Y

TABLE 2 — INDEXED ADDRESSING MODE

Type	Forms	Non Indirect			Indirect		
		Assembler Form	Postbyte Opcode	+ ~ #	Assembler Form	Postbyte Opcode	+ ~ #
Constant Offset From R (2s Complement Offsets)	No Offset	,R	1RR00100	0 0	[,R]	1RR10100	3 0
	5-Bit Offset	n, R	0RRnnnnn	1 0	defaults to 8-bit		
	8-Bit Offset	n, R	1RR01000	1 1	[n, R]	1RR11000	4 1
	16-Bit Offset	n, R	1RR01001	4 2	[n, R]	1RR11001	7 2
Accumulator Offset From R (2s Complement Offsets)	A Register Offset	A, R	1RR00110	1 0	[A, R]	1RR10110	4 0
	B Register Offset	B, R	1RR00101	1 0	[B, R]	1RR10101	4 0
	D Register Offset	D, R	1RR01011	4 0	[D, R]	1RR11011	7 0
	Auto Increment/Decrement R	Increment By 1	,R+	1RR00000	2 0	not allowed	
	Increment By 2	,R++	1RR00001	3 0	[,R++]	1RR10001	6 0
	Decrement By 1	,-R	1RR00010	2 0	not allowed		
	Decrement By 2	,--R	1RR00011	3 0	[,--R]	1RR10011	6 0
Constant Offset From PC (2s Complement Offsets)	8-Bit Offset	n, PCR	1xx01100	1 1	[n, PCR]	1xx11100	4 1
	16-Bit Offset	n, PCR	1xx01101	5 2	[n, PCR]	1xx11101	8 2
Extended Indirect	16-Bit Address	-	-	-	[n]	10011111	5 2

R = X, Y, U or S
 RR: 00=X, 01=Y, 10=U, 11=S
 x = Don't Care

+ and # indicate the number of additional cycles and bytes respectively for the particular indexing variation.

ACCUMULATOR-OFFSET INDEXED — This mode is similar to constant offset indexed except that the twos complement value in one of the accumulators (A, B, or D) and the contents of one of the pointer registers are added to form the effective address of the operand. The contents of both the accumulator and the pointer register are unchanged by the addition. The postbyte specifies which accumulator to use as an offset and no additional bytes are required. The advantage of an accumulator offset is that the value of the offset can be calculated by a program at run-time.

Some examples are:

```
LDA B, Y
LDX D, Y
LEAX B, X
```

AUTO INCREMENT/DECREMENT INDEXED — In the auto increment addressing mode, the pointer register contains the address of the operand. Then, after the pointer register is used, it is incremented by one or two. This addressing mode is useful in stepping through tables, moving data, or creating software stacks. In auto decrement, the pointer register is decremented prior to use as the address of the data. The use of auto decrement is similar to that of auto increment, but the tables, etc., are scanned from the high to low addresses. The size of the increment/decrement can be either one or two to allow for tables of either 8- or 16-bit data to be accessed and is selectable by the programmer. The pre-decrement, post-increment nature of these modes allows them to be used to create additional software stacks that behave identically to the U and S stacks.

Some examples of the auto increment/decrement addressing modes are:

```
LDA ,X+
STD ,Y+ +
LDB , - Y
LDX , - - S
```

Care should be taken in performing operations on 16-bit pointer registers (X, Y, U, S) where the same register is used to calculate the effective address.

Consider the following instruction:

```
STX 0,X+ + (X initialized to 0)
```

The desired result is to store a zero in locations \$0000 and \$0001, then increment X to point to \$0002. In reality, the following occurs:

```
0 → temp      calculate the EA; temp is a holding register
X + 2 → X      perform auto increment
X → (temp)     do store operation
```

INDEXED INDIRECT

All of the indexing modes, with the exception of auto increment/decrement by one or a ± 5 -bit offset, may have an additional level of indirection specified. In indirect addressing, the effective address is contained at the location specified by the contents of the index register plus any offset. In the example below, the A accumulator is loaded indirectly using an effective address calculated from the index register and an offset.

```
Before Execution
A = XX (don't care)
X = $F000
```

```
$0100 LDA [$10,X]   EA is now $F010
$F010 $F1           $F150 is now the
$F011 $50           new EA
$F150 $AA
```

After Execution

```
A = $AA (actual data loaded)
X = $F000
```

All modes of indexed indirect are included except those which are meaningless (e.g., auto increment/decrement by 1 indirect). Some examples of indexed indirect are:

```
LDA [,X]
LDD [10,S]
LDA [B,Y]
LDD [,X+ +]
```

RELATIVE ADDRESSING

The byte(s) following the branch opcode is (are) treated as a signed offset which may be added to the program counter. If the branch condition is true, then the calculated address (PC + signed offset) is loaded into the program counter. Program execution continues at the new location as indicated by the PC; short (one byte offset) and long (two bytes offset) relative addressing modes are available. All of memory can be reached in long relative addressing as an effective address interpreted modulo 2^{16} . Some examples of relative addressing are:

```
BEQ CAT (short)
BGT DOG (short)
CAT LBEG RAT (long)
DOG LBGT RABBIT (long)
•
•
•
RAT NOP
RABBIT NOP
```

PROGRAM COUNTER RELATIVE

The PC can be used as the pointer register with 8- or 16-bit signed offsets. As in relative addressing, the offset is added to the current PC to create the effective address. The effective address is then used as the address of the operand or data. Program counter relative addressing is used for writing position independent programs. Tables related to a particular routine will maintain the same relationship after the routine is moved, if referenced relative to the program counter. Examples are:

```
LDA CAT, PCR
LEAX TABLE, PCR
Since program counter relative is a type of indexing, an
additional level of indirection is available.
LDA [CAT, PCR]
LDU [DOG, PCR]
```

INSTRUCTION SET

The instruction set of the EF6809E is similar to that of the EF6800 and is upward compatible at the source code level. The number of opcodes has been reduced from 72 to 59, but because of the expanded architecture and additional addressing modes, the number of available opcodes (with different addressing modes) has risen from 197 to 1464.

Some of the new instructions are described in detail below.

PSHU/PSHS

The push instructions have the capability of pushing onto either the hardware stack (S) or user stack (U) any single register or set of registers with a single instruction.

PULU/PULS

The pull instructions have the same capability of the push instruction, in reverse order. The byte immediately following the push or pull opcode determines which register or registers are to be pushed or pulled. The actual push/pull sequence is fixed, each bit defines a unique register to push or pull, as shown below.

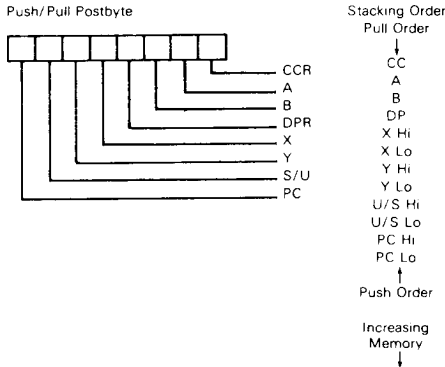

TFR/EXG

Within the EF6809E, any register may be transferred to or exchanged with another of like size; i.e., 8-bit to 8-bit or 16-bit to 16-bit. Bits 4-7 of postbyte define the source register, while bits 0-3 represent the destination register. These are denoted as follows:

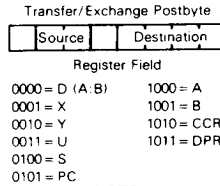

NOTE

All other combinations are undefined and INVALID.

LEAX/LEAY/LEAU/LEAS

The LEA (load effective address) works by calculating the effective address used in an indexed instruction and stores that address value, rather than the data at that address, in a pointer register. This makes all the features of the internal addressing hardware available to the programmer. Some of the implications of this instruction are illustrated in Table 3.

The LEA instruction also allows the user to access data and tables in a position independent manner. For example:

```
LEAX MSG1, PCR
LBSR PDATA (Print message routine)
•
•
MSG1 FCC 'MESSAGE'
```

This sample program prints: 'MESSAGE'. By writing MSG1, PCR, the assembler computes the distance between the present address and MSG1. This result is placed as a constant into the LEAX instruction which will be indexed from the PC value at the time of execution. No matter where the code is located when it is executed, the computed offset from the PC will put the absolute address of MSG1 into the X pointer register. This code is totally position independent.

The LEA instructions are very powerful and use an internal holding register (temp). Care must be exercised when using the LEA instructions with the auto increment and auto decrement addressing modes due to the sequence of internal operations. The LEA internal sequence is outlined as follows:

LEAa ,b+ (any of the 16-bit pointer registers X, Y, U, or S may be substituted for a and b.)

1. b → temp (calculate the EA)
2. b+1 → b (modify b, postincrement)
3. temp → a (load a)

LEAa , - b

1. b-1 → temp (calculate EA with predecrement)
2. b-1 → b (modify b, predecrement)
3. temp → a (load a)

TABLE 3 — LEA EXAMPLES

Instruction	Operation	Comment
LEAX 10, X	X + 10 → X	Adds 5-Bit Constant 10 to X
LEAX 500, X	X + 500 → X	Adds 16-Bit Constant 500 to X
LEAY A, Y	Y + A → Y	Adds 8-Bit A Accumulator to Y
LEAY D, Y	Y + D → Y	Adds 16-Bit D Accumulator to Y
LEAU -10, U	U - 10 → U	Subtracts 10 from U
LEAS -10, S	S - 10 → S	Used to Reserve Area on Stack
LEAS 10, S	S + 10 → S	Used to 'Clean Up' Stack
LEAX 5, S	S + 5 → X	Transfers As Well As Adds

Auto increment-by-two and auto decrement-by-two instructions work similarly. Note that LEAX ,X+ does not change X, however LEAX , - X does decrement X. LEAX 1,X should be used to increment X by one.

MUL

Multiplies the unsigned binary numbers in the A and B accumulator and places the unsigned result into the 16-bit D accumulator. This unsigned multiply also allows multiple-precision multiplications.

LONG AND SHORT RELATIVE BRANCHES

The EF6809E has the capability of program counter relative branching throughout the entire memory map. In this mode, if the branch is to be taken, the 8- or 16-bit signed offset is added to the value of the program counter to be used as the effective address. This allows the program to branch anywhere in the 64K memory map. Position independent code can be easily generated through the use of relative branching. Both short (8 bit) and long (16 bit) branches are available.

SYNC

After encountering a sync instruction, the MPU enters a sync state, stops processing instructions, and waits for an interrupt. If the pending interrupt is non-maskable (NMI) or maskable (FIRQ, IRQ) with its mask bit (F or I) clear, the processor will clear the sync state and perform the normal interrupt stacking and service routine. Since FIRQ and IRQ are not edge-triggered, a low level with a minimum duration of three bus cycles is required to assure that the interrupt will be taken. If the pending interrupt is maskable (FIRQ, IRQ) with its mask bit (F or I) set, the processor will clear the sync state and continue processing by executing the next in-line instruction. Figure 16 depicts sync timing.

SOFTWARE INTERRUPTS

A software interrupt is an instruction which will cause an interrupt and its associated vector fetch. These software interrupts are useful in operating system calls, software debugging, trace operations, memory mapping, and software development systems. Three levels of SWI are available on this EF6809E and are prioritized in the following order: SWI, SWI2, SWI3.

16-BIT OPERATION

The EF6809E has the capability of processing 16-bit data. These instructions include loads, stores, compares, adds, subtracts, transfers, exchanges, pushes, and pulls.

CYCLE-BY-CYCLE OPERATION

The address bus cycle-by-cycle performance chart (Figure 16) illustrates the memory-access sequence corresponding to each possible instruction and addressing mode in the EF6809E. Each instruction begins with an opcode fetch. While that opcode is being internally decoded, the next program byte is always fetched. (Most instructions will use the next byte, so this technique considerably speeds throughput.) Next, the operation of each opcode will follow the flowchart. VMA is an indication of FFFF₁₆ on the address bus, R/W=1 and BS=0. The following examples illustrate the use of the chart.

Example 1: LBSR (Branch Taken) Before Execution SP = F000

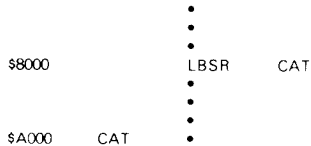

CYCLE-BY-CYCLE FLOW

Cycle #	Address	Data	R/W	Description
1	8000	17	1	Opcode Fetch
2	8001	20	1	Offset High Byte
3	8002	00	1	Offset Low Byte
4	FFFF	*	1	VMA Cycle
5	FFFF	*	1	VMA Cycle
6	A000	*	1	Computed Branch Address
7	FFFF	*	1	VMA Cycle
8	EEEE	80	0	Stack High Order Byte of Return Address
9	EFEE	03	0	Stack Low Order Byte of Return Address

Example 2: DEC (Extended)

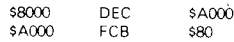

CYCLE-BY-CYCLE FLOW

Cycle #	Address	Data	R/W	Description
1	8000	7A	1	Opcode Fetch
2	8001	A0	1	Operand Address, High Byte
3	8002	00	1	Operand Address, Low Byte
4	FFFF	*	1	VMA Cycle
5	A000	80	1	Read the Data
6	FFFF	*	1	VMA Cycle
7	FFFF	7F	0	Store the Decrementd Data

* The data bus has the data at that particular address.

INSTRUCTION SET TABLES

The instructions of the EF6809E have been broken down into five different categories. They are as follows:

- 8-bit operation (Table 4)
- 16-bit operation (Table 5)
- Index register/stack pointer instructions (Table 6)
- Relative branches (long or short) (Table 7)
- Miscellaneous instructions (Table 8)

Hexadecimal values for the instructions are given in Table 9.

PROGRAMMING AID

Figure 18 contains a compilation of data that will assist you in programming the EF6809E.

FIGURE 16 — SYNC TIMING

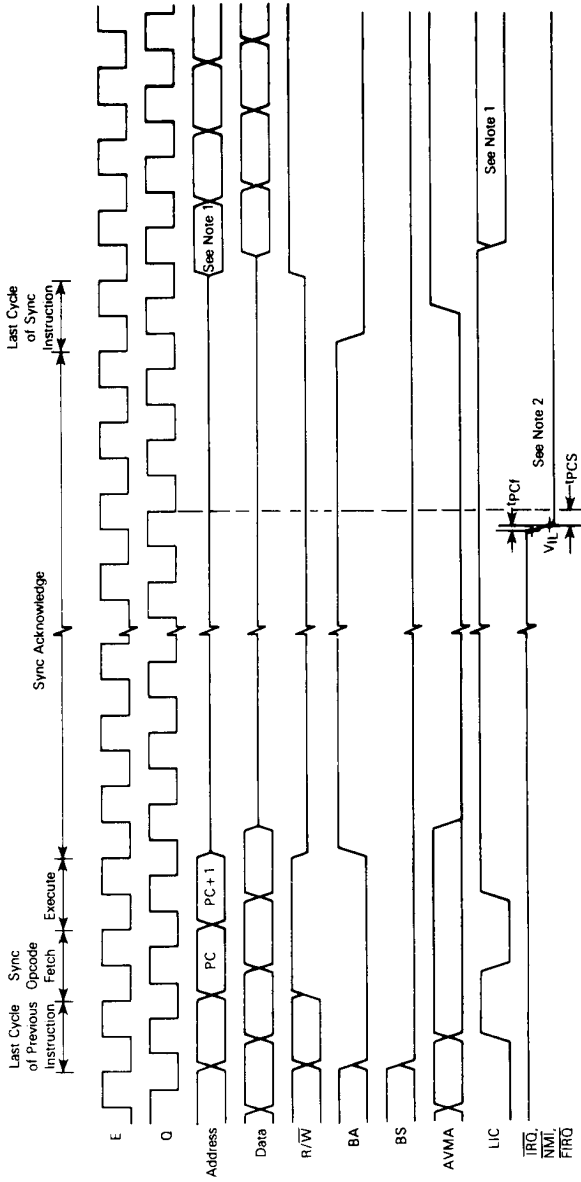

- NOTES:
1. If the associated mask bit is set when the interrupt is requested, LIC will go low and this cycle will be an instruction fetch from address location PC+1. However, if the interrupt is accepted (NMI or an unmasked FIRQ or IRQ) LIC will remain high and interrupt processing will start with this cycle as in Figures 8 and 9 (Interrupt Timing).
 2. If mask bits are clear, IRQ and FIRQ must be held low for three cycles to guarantee that interrupt will be taken, although only one cycle is necessary to bring the processor out of SYNC.
 3. Timing measurements are referenced to and from a low voltage of 0.8 volts and a high voltage of 2.0 volts, unless otherwise noted.

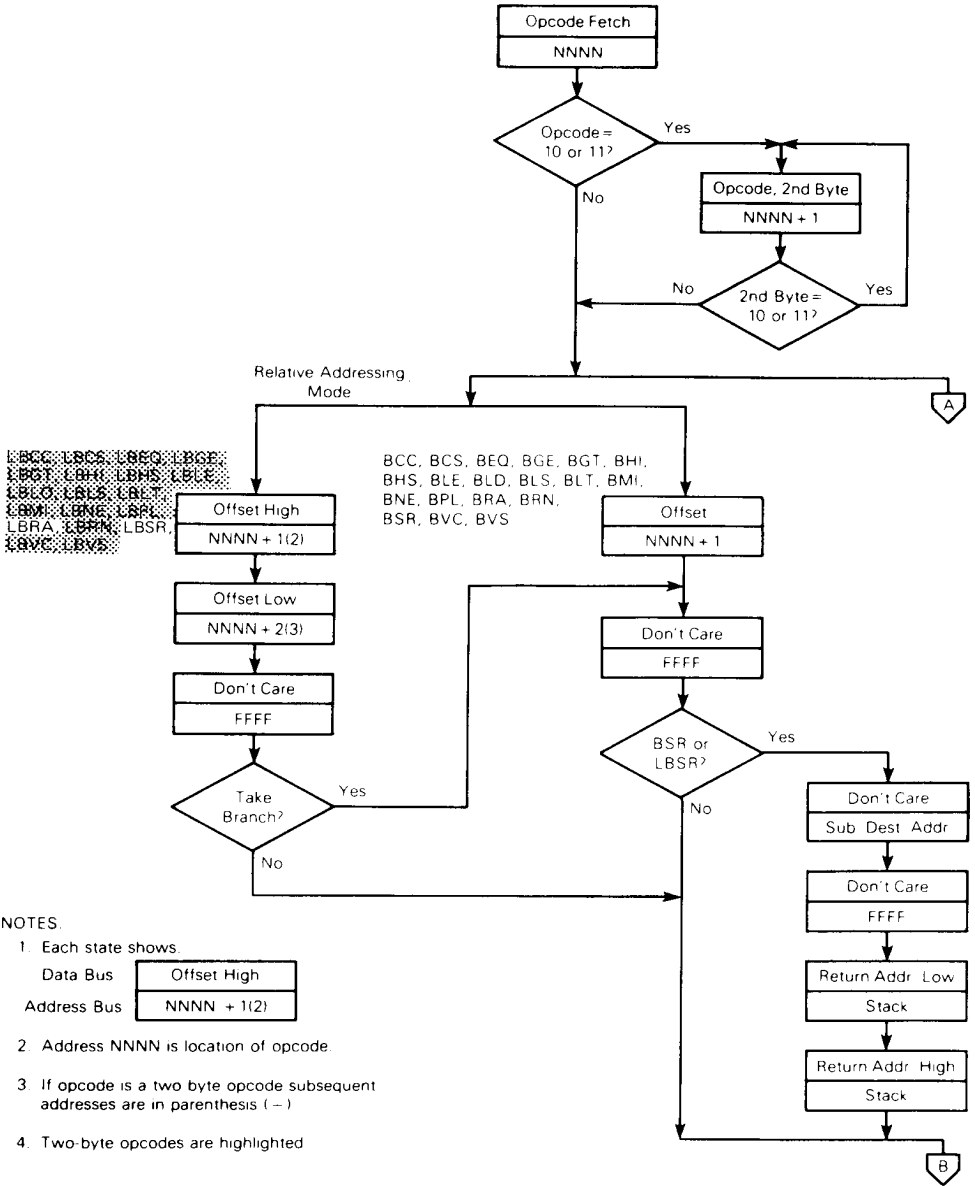

NOTES.

1. Each state shows
 Data Bus

Offset High

 Address Bus

NNNN + 1(2)

2. Address NNNN is location of opcode
3. If opcode is a two byte opcode subsequent addresses are in parenthesis (-)
4. Two-byte opcodes are highlighted

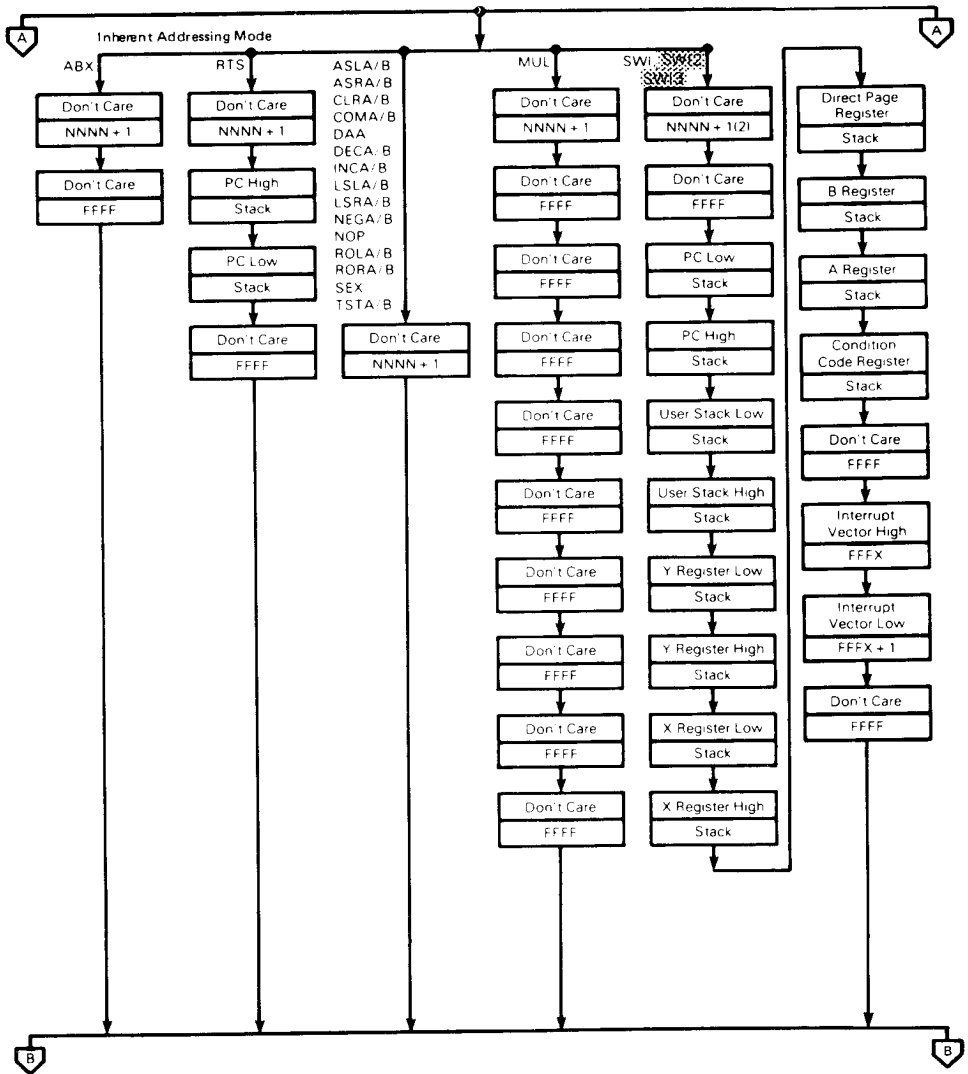

FIGURE 17 — CYCLE-BY-CYCLE PERFORMANCE (Sheet 3 of 9)

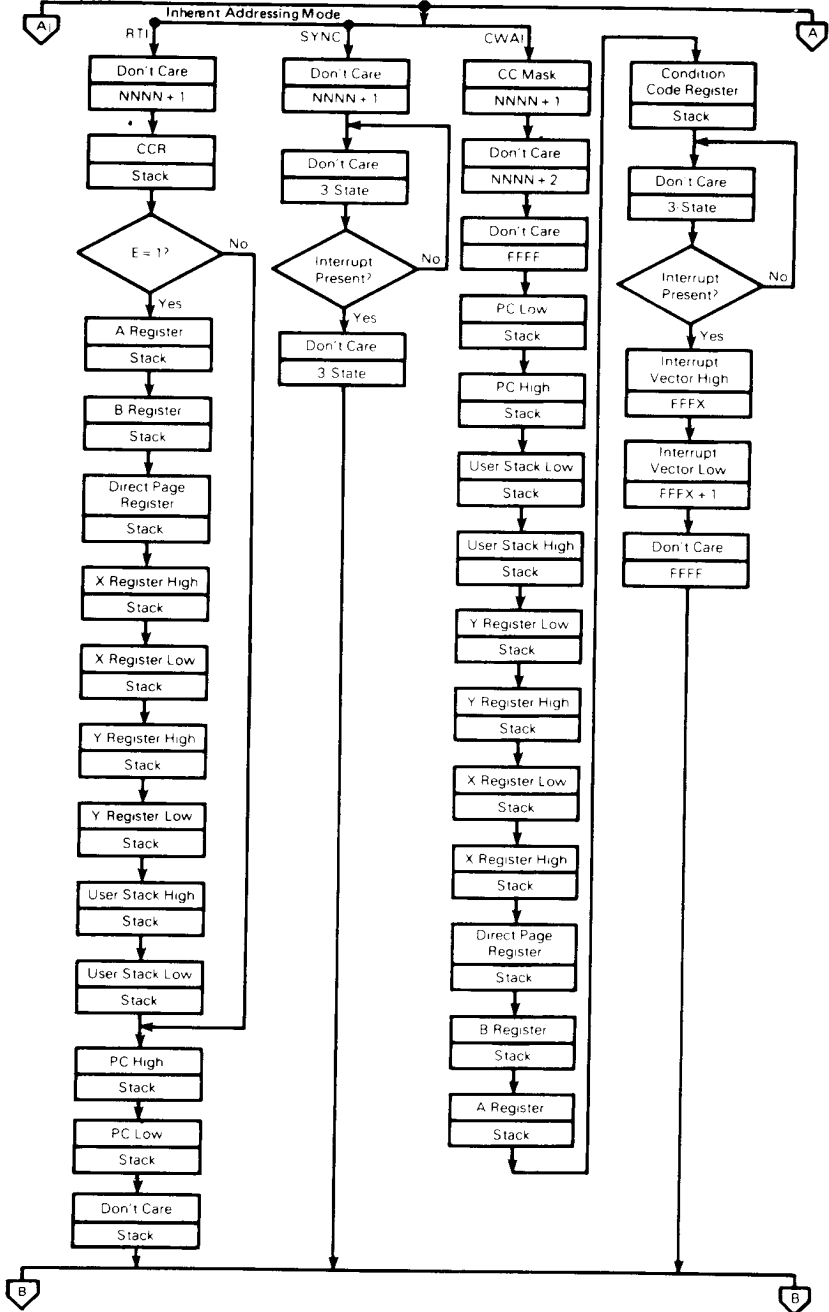

FIGURE 17 – CYCLE-BY-CYCLE PERFORMANCE (Sheet 4 of 9)

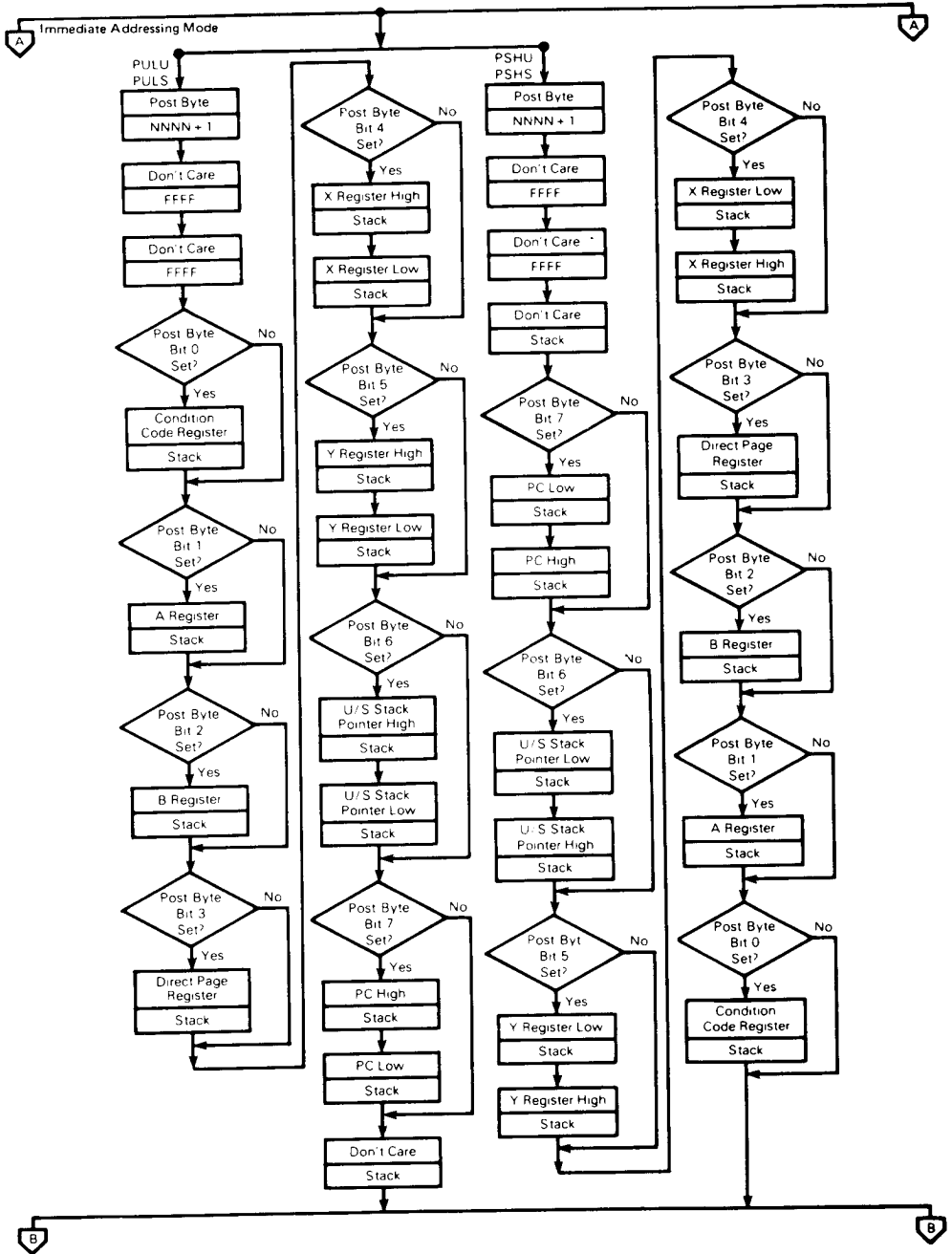

FIGURE 17 - CYCLE-BY-CYCLE PERFORMANCE (Sheet 5 of 9)

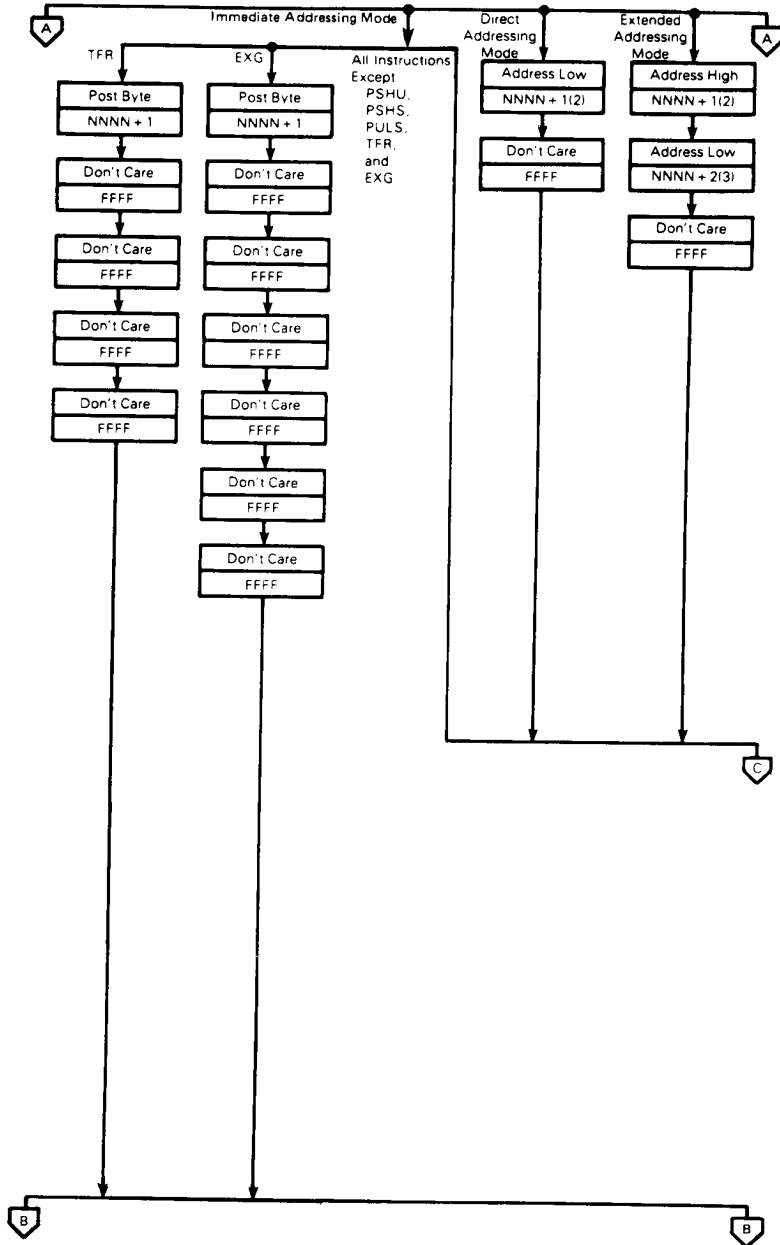

FIGURE 17 – CYCLE-BY-CYCLE PERFORMANCE (Sheet 6 of 9)

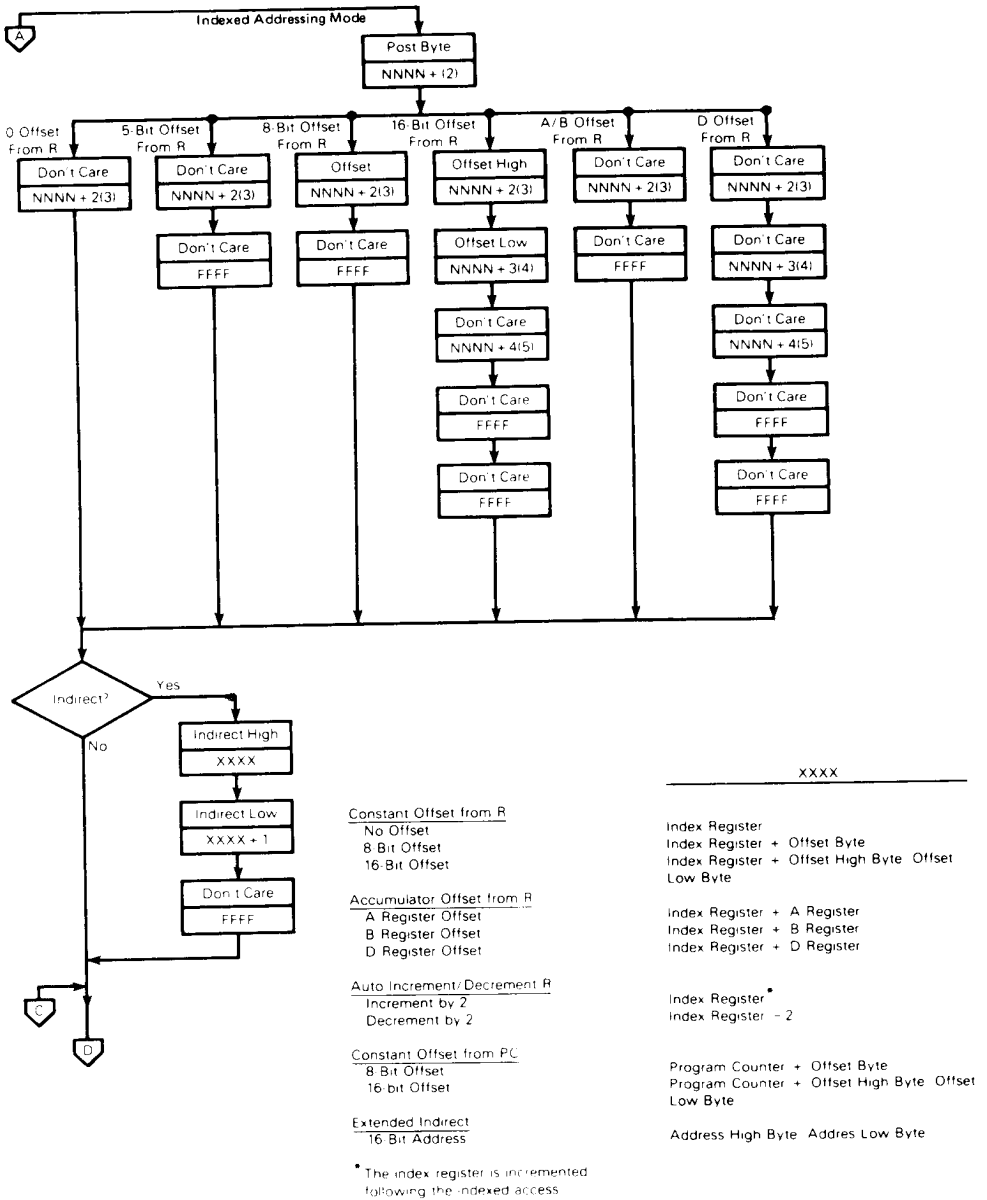
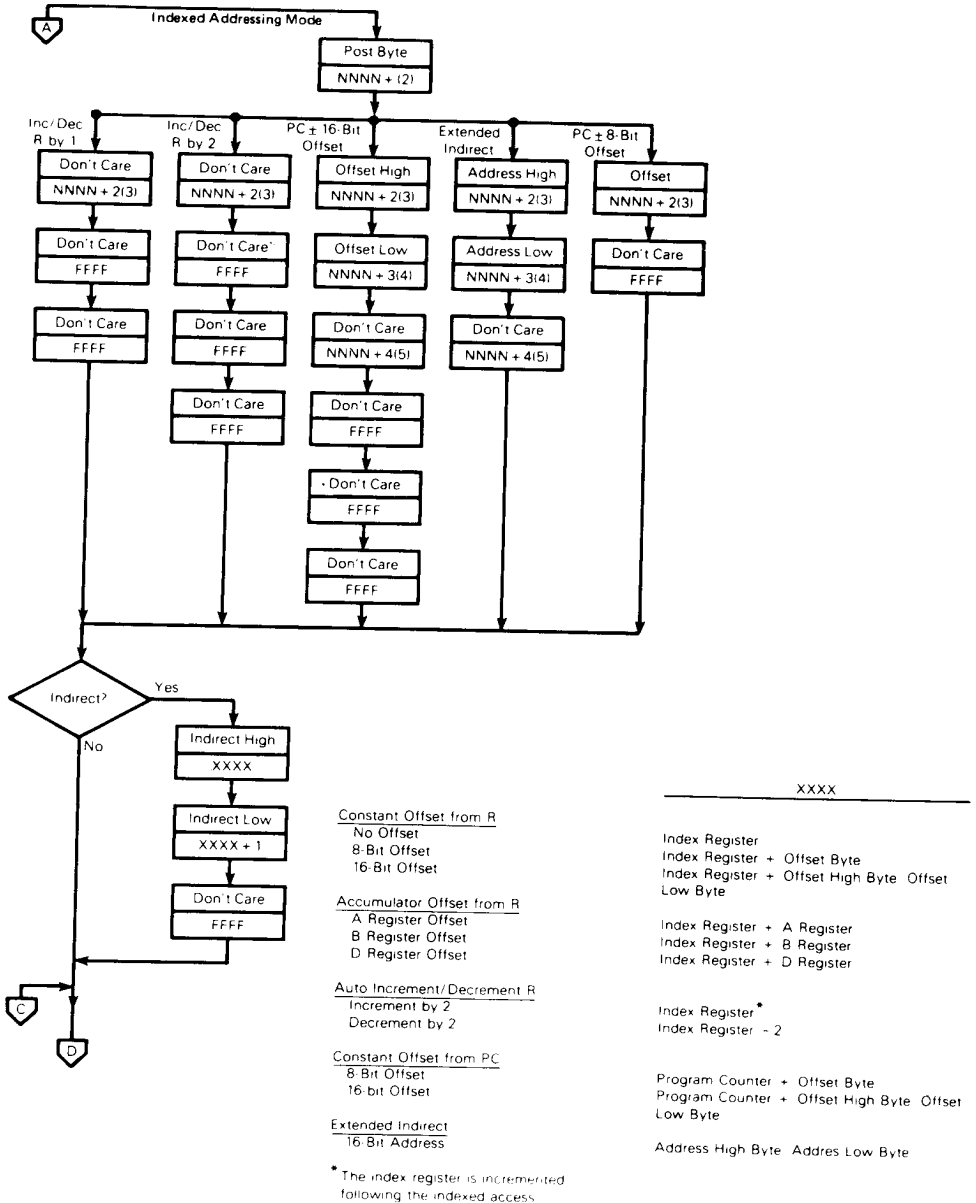
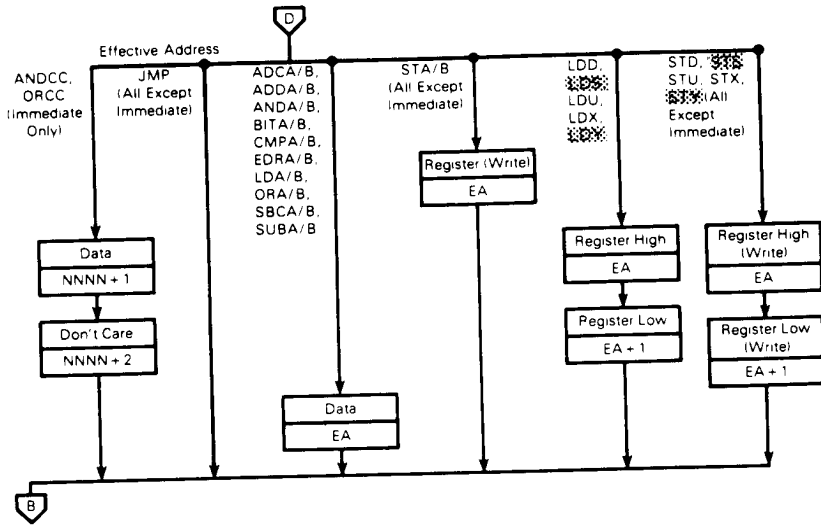

FIGURE 17 – CYCLE-BY-CYCLE PERFORMANCE (Sheet 7 of 9)





Effective Address (EA)

Constant Offset from R

- No Offset
- 5-Bit Offset
- 8-Bit Offset
- 16-Bit Offset

Accumulator Offset from R

- A Register Offset
- B Register Offset
- D Register Offset

Auto Increment/Decrement R

- Increment by 1
- Increment by 2
- Decrement by 1
- Decrement by 2

Constant Offset from PC

- 8 Bit Offset
- 16 Bit Offset

Direct

Extended

Immediate

* The index register is incremented following the indexed access

- Index Register
- Index Register
- Index Register + Post Byte
- Index Register + Post Byte High Post Byte Low

- Index Register + A Register
- Index Register + B Register
- Index Register + D Register

- Index Register *
- Index Register
- Index Register - 1
- Index Register - 2

- Program Counter + Offset Byte
- Program Counter + Offset High Byte Offset Low Byte

Direct Page Register Address Low

Address High Address Low

NNNN + 1

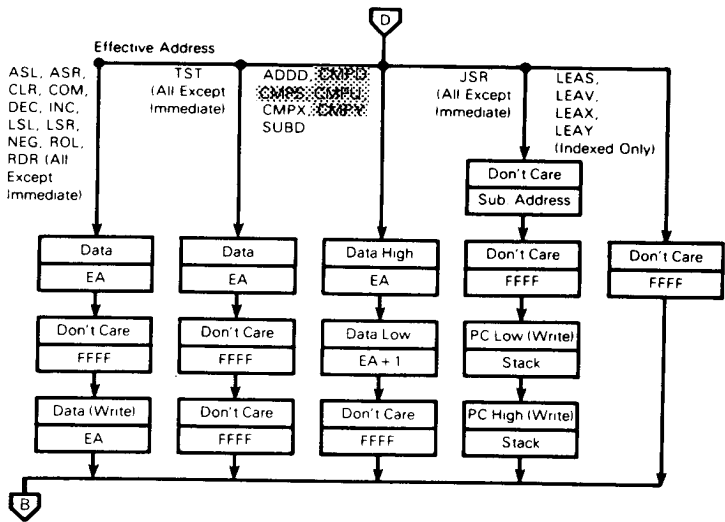

Effective Address (EA)

Constant Offset from R

- No Offset
- 5-Bit Offset
- 8-Bit Offset
- 16-Bit Offset

- Index Register
- Index Register
- Index Register + Post Byte
- Index Register + Post Byte High Post Byte Low

Accumulator Offset from R

- A Register Offset
- B Register Offset
- D Register Offset

- Index Register + A Register
- Index Register + B Register
- Index Register + D Register

Auto Increment/Decrement R

- Increment by 1
- Increment by 2
- Decrement by 1
- Decrement by 2

- index Register +
- Index Register -
- Index Register - 1
- Index Register - 2

Constant Offset from PC

- 8-Bit Offset
- 16-Bit Offset

- Program Counter + Offset Byte
- Program Counter - Offset High Byte Offset Low Byte

Direct

Direct Page Register Address Low

Extended

Address High Address Low

Immediate

NNNN + 1

* The index register is incremented following the indexed access

TABLE 4 — 8-BIT ACCUMULATOR AND MEMORY INSTRUCTIONS

Mnemonic(s)	Operation
ADCA, ADCB	Add memory to accumulator with carry
ADDA, ADDB	Add memory to accumulator
ANDA, ANDB	And memory with accumulator
ASL, ASLA, ASLB	Arithmetic shift of accumulator or memory left
ASR, ASRA, ASRB	Arithmetic shift of accumulator or memory right
BITA, BITB	Bit test memory with accumulator
CLR, CLRA, CLRB	Clear accumulator or memory location
CMPA, CMPB	Compare memory from accumulator
COM, COMA, COMB	Complement accumulator or memory location
DAA	Decimal adjust A accumulator
DEC, DECA, DECB	Decrement accumulator or memory location
EORA, EORB	Exclusive or memory with accumulator
EXG R1, R2	Exchange R1 with R2 (R1, R2 = A, B, CC, DP)
INC, INCA, INCB	Increment accumulator or memory location
LDA, LDB	Load accumulator from memory
LSL, LSLA, LSLB	Logical shift left accumulator or memory location
LSR, LSRA, LSB	Logical shift right accumulator or memory location
MUL	Unsigned multiply (A × B → D)
NEG, NEGA, NEGB	Negate accumulator or memory
ORA, ORB	Or memory with accumulator
ROL, ROLA, ROLB	Rotate accumulator or memory left
ROR, RORA, RORB	Rotate accumulator or memory right
SBCA, SBCB	Subtract memory from accumulator with borrow
STA, STB	Store accumulator to memory
SUBA, SUBB	Subtract memory from accumulator
TST, TSTA, TSTB	Test accumulator or memory location
TFR R1, R2	Transfer R1 to R2 (R1, R2 = A, B, CC, DP)

NOTE: A, B, CC or DP may be pushed to (pulled from) either stack with PSHS, PSHU (PULS, PULU) instructions.

TABLE 5 — 16-BIT ACCUMULATOR AND MEMORY INSTRUCTIONS

Mnemonic(s)	Operation
ADDD	Add memory to D accumulator
CMPD	Compare memory from D accumulator
EXG D, R	Exchange D with X, Y, S, U or PC
LDD	Load D accumulator from memory
SEX	Sign Extend B accumulator into A accumulator
STD	Store D accumulator to memory
SUBD	Subtract memory from D accumulator
TFR D, R	Transfer D to X, Y, S, U or PC
TFR R, D	Transfer X, Y, S, U or PC to D

NOTE: D may be pushed (pulled) to either stack with PSHS, PSHU (PULS, PULU) instructions.

TABLE 6 — INDEX REGISTER/STACK POINTER INSTRUCTIONS

Instruction	Description
CMPS, CMPU	Compare memory from stack pointer
CMPX, CMPY	Compare memory from index register
EXG R1, R2	Exchange D, X, Y, S, U or PC with D, X, Y, S, U or PC
LEAS, LEAU	Load effective address into stack pointer
LEAX, LEAY	Load effective address into index register
LDS, LDU	Load stack pointer from memory
LDX, LDY	Load index register from memory
PSHS	Push A, B, CC, DP, D, X, Y, U, or PC onto hardware stack
PSHU	Push A, B, CC, DP, D, X, Y, S, or PC onto user stack
PULS	Pull A, B, CC, DP, D, X, Y, U, or PC from hardware stack
PULU	Pull A, B, CC, DP, D, X, Y, S, or PC from hardware stack
STS, STU	Store stack pointer to memory
STX, STY	Store index register to memory
TFR R1, R2	Transfer D, X, Y, S, U or PC to D, X, Y, S, U or PC
ABX	Add B accumulator to X (unsigned)

TABLE 7 – BRANCH INSTRUCTIONS

Instruction	Description
SIMPLE BRANCHES	
BEO, LBEO	Branch if equal
BNE, LBNE	Branch if not equal
BMI, LBMI	Branch if minus
BPL, LBPL	Branch if plus
BCS, LBCS	Branch if carry set
BCC, LBCC	Branch if carry clear
BVS, LBVS	Branch if overflow set
BVC, LBVC	Branch if overflow clear
SIGNED BRANCHES	
BGT, LBGT	Branch if greater (signed)
BVS, LBVS	Branch if invalid 2's complement result
BGE, LBGE	Branch if greater than or equal (signed)
BEO, LBEO	Branch if equal
BNE, LBNE	Branch if not equal
BLE, LBLE	Branch if less than or equal (signed)
BVC, LBVC	Branch if valid 2's complement result
BLT, LBLT	Branch if less than (signed)
UNSIGNED BRANCHES	
BHI, LBHI	Branch if higher (unsigned)
BCC, LBCC	Branch if higher or same (unsigned)
BHS, LBHS	Branch if higher or same (unsigned)
BEO, LBEO	Branch if equal
BNE, LBNE	Branch if not equal
BLS, LBLS	Branch if lower or same (unsigned)
BCL, LBCL	Branch if lower (unsigned)
BLO, LBLO	Branch if lower (unsigned)
OTHER BRANCHES	
BSR, LBSR	Branch to subroutine
BRA, LBRA	Branch always
BRN, LBRN	Branch never

TABLE 8 – MISCELLANEOUS INSTRUCTIONS

Instruction	Description
ANDCC	AND condition code register
CWAI	AND condition code register, then wait for interrupt
NOP	No operation
ORCC	OR condition code register
JMP	Jump
JSR	Jump to subroutine
RTI	Return from interrupt
RTS	Return from subroutine
SWI, SWI2, SWI3	Software interrupt (absolute indirect)
SYNC	Synchronize with interrupt line

TABLE 9 -- HEXADECIMAL VALUES OF MACHINE CODES

OP	Mnem	Mode	~	#	OP	Mnem	Mode	~	#	OP	Mnem	Mode	~	#		
00	NEG	Direct ↑	6	2	30	LEAX	Indexed ↓	4+	2+	60	NEG	Indexed ↑	6+	2+		
01	*		02	*	31	LEAY		4+	2+	61	*					
03	COM		6	2	32	LEAS		4+	2+	62	*					
04	LSR		6	2	33	LEAU		Indexed	4+	2+	63		COM	6+	2+	
05	*		6	2	34	PSHS		Immed	5+	2	64		LSR	6+	2+	
06	ROR		6	2	35	PULS		Immed	5+	2	65		*			
07	ASR		6	2	36	PSHU		Immed	5+	2	66		ROR	6+	2+	
08	ASL, LSL		6	2	37	PULU		Immed	5+	2	67		ASR	6+	2+	
09	ROL		6	2	38	*		—	—	—	68		ASL, LSL	6+	2+	
0A	DEC		6	2	39	RTS		Inherent	5	1	69		ROL	6+	2+	
0B	*	6	2	3A	ABX	↑	3	1	6A	DEC	6+	2+				
0C	INC	6	2	3B	RTI		6/15	1	6B	*						
0D	TST	6	2	3C	CWAI	↓	≥20	2	6C	INC	6+	2+				
0E	JMP	6	2	3D	MUL		Inherent	11	1	6D	TST	6+	2+			
0F	CLR	3	2	3E	*	—	—	—	6E	JMP	3+	2+				
		Direct	3	2	3F	SWI	Inherent	19	1	6F	CLR	Indexed	3+	2+		
10	Page 2	—	—	—	40	NEGA	Inherent ↑	2	1	70	NEG	Extended ↑	7	3		
11	Page 3	—	—	—	41	*		—	—	71	*					
12	NOP	Inherent	2	1	42	*		2	1	72	*					
13	SYNC	Inherent	≥4	1	43	COMA		2	1	73	COM		7	3		
14	*	—	—	—	44	LSRA		2	1	74	LSR		7	3		
15	*	—	—	—	45	*		—	—	75	*					
16	LBRA	Relative	5	3	46	RORA		2	1	76	ROR		7	3		
17	LBSR	Relative	9	3	47	ASRA		2	1	77	ASR		7	3		
18	*	—	—	—	48	ASLA, LSLA		2	1	78	ASL, LSL		7	3		
19	DAA	Inherent	2	1	49	ROLA		2	1	79	ROL		7	3		
1A	ORCC	Immed	3	2	4A	DECA	2	1	7A	DEC	7	3				
1B	*	—	—	—	4B	*	—	—	7B	*						
1C	ANDCC	Immed	3	2	4C	INCA	2	1	7C	INC	7	3				
1D	SEX	Inherent	2	1	4D	TSTA	2	1	7D	TST	7	3				
1E	EXG	Immed	8	2	4E	*	—	—	7E	JMP	4	3				
1F	TFR	Immed	6	2	4F	CLRA	Inherent	2	1	7F	CLR	Extended	7	3		
20	BRA	Relative ↑	3	2	50	NEGB	Inherent ↑	2	1	80	SUBA	Immed ↑	2	2		
21	BRN		3	2	51	*		—	—	81	CMPA		2	2		
22	BHI		3	2	52	*		2	1	82	SBCA		2	2		
23	BLS		3	2	53	COMB		2	1	83	SUBD		4	3		
24	BHS, BCC		3	2	54	LSRB		2	1	84	ANDA		2	2		
25	BLO, BCS		3	2	55	*		2	1	85	BITA		2	2		
26	BNE		3	2	56	RORB		2	1	86	LDA		2	2		
27	BEQ		3	2	57	ASRB		2	1	87	*					
28	BVC		3	2	58	ASLB, LSLB		2	1	88	EORA		2	2		
29	BVS		3	2	59	ROLB		2	1	89	ADCA		2	2		
2A	BPL		3	2	5A	DECB		2	1	8A	ORA		2	2		
2B	BMI		3	2	5B	*		2	1	8B	ADDA		2	2		
2C	BGE		3	2	5C	INCB		2	1	8C	CMPX		4	3		
2D	BLT		3	2	5D	TSTB		2	1	8D	BSR		7	2		
2E	BGT		3	2	5E	*		—	—	8E	LDX		3	3		
2F	BLE		Relative	3	2	5F		CLRB	Inherent	2	1		8F	*	Immed	Immed

LEGEND:

- ~ Number of MPU cycles (less possible push pull or indexed-mode cycles)
- # Number of program bytes
- * Denotes unused opcode

TABLE 9 - HEXADECIMAL VALUES OF MACHINE CODES (CONTINUED)

OP	Mnem	Mode	-	#	OP	Mnem	Mode	-	#	OP	Mnem	Mode	-	#
90	SUBA	Direct ↑	4	2	C0	SUBB	Immed ↑	2	2	Page 2 and 3 Machine Codes				
91	CMPA		4	2	C1	CMPB		2	2					
92	SBCA		4	2	C2	SBCB		2	2	1021	LBRN	Relative ↑	5	4
93	SUBD		6	2	C3	ADDD		4	3	1022	LBHI		5(6)	4
94	ANDA		4	2	C4	ANDB		2	2	1023	LBLS		5(6)	4
95	BITA		4	2	C5	BITB		2	2	1024	LBHS, LBCC		5(6)	4
96	LDA		4	2	C6	LDB		2	2	1025	LBCS, LBLO		5(6)	4
97	STA		4	2	C7	*				1026	LBNE		5(6)	4
98	EORA		4	2	C8	EORB		2	2	1027	LBEQ		5(6)	4
99	ADCA		4	2	C9	ADCB		2	2	1028	LBVC		5(6)	4
9A	ORA	4	2	CA	ORB	2	2	1029	LBVS	5(6)	4			
9B	ADDA	4	2	CB	ADDB	2	2	102A	LBPL	5(6)	4			
9C	CMPX	6	2	CC	LDD	3	3	102B	LBMI	5(6)	4			
9D	JSR	7	2	CD	*			102C	LBGE	5(6)	4			
9E	LDX	5	2	CE	LDU	3	3	102D	LBLT	5(6)	4			
9F	STX	5	2	CF	*			102E	LBGT	5(6)	4			
A0	SUBA	Indexed ↑	4+	2+	D0	SUBB	Direct ↑	4	2	102F	LBLE	5(6)	4	
A1	CMPA		4+	2+	D1	CMPB		4	2	103F	SWI2	20	2	
A2	SBCA		4+	2+	D2	SBCB		4	2	1083	CMPD	5	4	
A3	SUBD		6+	2+	D3	ADDD		6	2	108C	CMPY	5	4	
A4	ANDA		4+	2+	D4	ANDB		4	2	108E	LDY	4	4	
A5	BITA		4+	2+	D5	BITB		4	2	1093	CMPD	7	3	
A6	LDA		4+	2+	D6	LDB		4	2	109C	CMPY	7	3	
A7	STA		4+	2+	D7	STB		4	2	109E	LDY	6	3	
A8	EORA		4+	2+	D8	EORB		4	2	109F	STY	6	3	
A9	ADCA		4+	2+	D9	ADCB		4	2	10A3	CMPD	7+	3+	
AA	ORA	4+	2+	DA	ORB	4	2	10AC	CMPY	7+	3+			
AB	ADDA	4+	2+	DB	ADDB	4	2	10AE	LDY	6+	3+			
AC	CMPX	6+	2+	DC	LDD	5	2	10AF	STY	6+	3+			
AD	JSR	7+	2+	DD	STD	5	2	10B3	CMPD	Extended	8	4		
AE	LDX	5+	2+	DE	LDU	5	2	10BC	CMPY	8	4			
AF	STX	5+	2+	DF	STU	5	2	10BE	LDY	7	4			
B0	SUBA	Extended ↑	5	3	E0	SUBB	Indexed ↑	4+	2+	10BF	STY	7	4	
B1	CMPA		5	3	E1	CMPB		4+	2+	10CE	LDS	immed	4	4
B2	SBCA		5	3	E2	SBCB		4+	2+	10DE	LDS	Direct	6	3
B3	SUBD		7	3	E3	ADDD		6+	2+	10DF	STS	Direct	6	3
B4	ANDA		5	3	E4	ANDB		4+	2+	10EE	LDS	Indexed	6+	3+
B5	BITA		5	3	E5	BITB		4+	2+	10EF	STS	Indexed	6+	3+
B6	LDA		5	3	E6	LDB		4+	2+	10FE	LDS	Extended	7	4
B7	STA		5	3	E7	STB		4+	2+	10FF	STS	Extended	7	4
B8	EORA		5	3	E8	EORB		4+	2+	113F	SWI3	Inherent	20	2
B9	ADCA		5	3	E9	ADCB		4+	2+	1183	CMPU	Immed	5	4
BA	ORA	5	3	EA	ORB	4+	2+	118C	CMPS	Immed	5	4		
BB	ADDA	5	3	EB	ADDB	4+	2+	1193	CMPU	Direct	7	3		
BC	CMPX	7	3	EC	LDD	5+	2+	119C	CMPS	Direct	7	3		
BD	JSR	8	3	ED	STD	5+	2+	11A3	CMPU	Indexed	7+	3+		
BE	LDX	6	3	EE	LDU	5+	2+	11AC	CMPS	Indexed	7+	3+		
BF	STX	6	3	EF	STU	5+	2+	11B3	CMPU	Extended	8	4		
NOTE: All unused opcodes are both undefined and illegal					F0	SUBB	Extended ↑	5	3	11BC	CMPS	Extended	8	4
					F1	CMPB		5	3					
					F2	SBCB		5	3					
					F3	ADDD		7	3					
					F4	ANDB		5	3					
					F5	BITB		5	3					
					F6	LDB		5	3					
					F7	STB		5	3					
					F8	EORB		5	3					
					F9	ADCB		5	3					
FA	ORB	5	3											
FB	ADDB	5	3											
FC	LDD	6	3											
FD	STD	6	3											
FE	LDU	6	3											
FF	STU	6	3											

FIGURE 18 - PROGRAMMING AID

Instruction	Forms	Addressing Modes												Description	H	3	2	1	0					
		Immediate			Direct			Indexed			Extended									Inherent				
		Op	-	#	Op	-	#	Op	-	#	Op	-	#							Op	-	#		
ABX															3A	3	1		B + X - X (Unsigned)	*	*	*	*	*
ADC	ADCA ADCB	89 C9	2 2	2 2	99 D9	4 4	2 2	A9 E9	4+ 4+	2+ 2+	B9 F9	5 5	3 3						A + M + C - A B + M + C - B	1	1	1	1	1
ADD	ADDA ADDB ADDD	8B CB C3	2 2 4	2 2 3	9B DB D3	4 4 6	2 2 2	AB EB F3	4+ 4+ 6+	2+ 2+ 2+	BB FB F3	5 5 7	3 3 3						A + M - A B + M - B D + M M + 1 - D	1	1	1	1	1
AND	ANDA ANDB ANDCC	84 C4 1C	2 2 3	2 2 2	94 D4 0C	4 4 3	2 2 2	A4 E4	4+ 4+	2+ 2+	B4 F4	5 5	3 3						A A M - A B A M - B CC A IMM - CC	*	1	1	0	*
ASL	ASLA ASLB ASL				08	6	2	68	6+	2+	78	7	3		48 58	2 2	1 1			8	1	1	1	1
ASR	ASRA ASRB ASR				07	6	2	67	6+	2+	77	7	3		47 57	2 2	1 1			8	1	1	1	1
BIT	BITA BITB	85 C5	2 2	2 2	95 D5	4 4	2 2	A5 E5	4+	2+	B5 F5	5 5	3 3						Bit Test: A (IM A A) Bit Test: B (IM A B)	*	1	1	0	*
CLR	CLRA CLRB CLR				0F	6	2	6F	6+	2+	7F	7	3		4F 5F	2 2	1 1		0 - A 0 - B 0 - M	*	0	1	0	0
CMP	CMPA CMPB CMPD CMPS CMPU CMPX CMPY	81 C1 10 83 11 11 83 8C 10 8C	2 2 5 5 5 5 4 4 5	2 2 4 4 4 4 3 3 4	91 D1 10 93 11 11 93 9C 7 9C	4 4 7 7 7 7 6 6 7	2 2 3 3 3 3 2 2 3	A1 E1 A3 AC A3 AC	4+ 4+ 7+	2+ 2+ 3+	B1 F1 10 B3 11 11 B3 BC 10 BC	5 5 8 8 8 8 7 7 8 8	3 3 4 4 4 4 3 3 4 4						Compare M from A Compare M from B Compare M:M+1 from D Compare M:M+1 from S Compare M:M+1 from U Compare M:M+1 from X Compare M:M+1 from Y	8	1	1	1	1
COM	COMA COMB COM				03	6	2	63	6+	2+	73	7	3		43 53	2 2	1 1		A - A B - B M - M	*	1	1	0	1
CWA!		3C	2	2	2														CC A IMM - CC Wait for Interrupt	*	1	1	0	1
DAA															19 5A	2 2	1 1		Decimal Adjust A	*	1	1	0	1
DEC	DECA DECB DEC				0A	6	2	6A	6+	2+	7A	7	3		4A 5A	2 2	1 1		A - 1 - A B - 1 - B M - 1 - M	*	1	1	1	*
EOR	EORA EORB	88 C8	2 2	2 2	98 D8	4 4	2 2	A8 E8	4+	2+	B8 F8	5 5	3 3						A ⊕ M - A B ⊕ M - B	*	1	1	0	*
EXG	R1, R2	1E	8	2															R1 - R2 ²	*	*	*	*	*
INC	INCA INCB INCL				0C	6	2	6C	6+	2+	7C	7	3		4C 5C	2 2	1 1		A + 1 - A B + 1 - B M + 1 - M	*	1	1	1	*
JMP					0E	3	2	6E	3+	2+	7E	4	3						EA ³ - PC	*	*	*	*	*
JSR					9D	7	2	AD	7+	2+	BD	8	3						Jump to Subroutine	*	*	*	*	*
LD	LDA LDB LDD LDS CE CE LDU LDX LDY	86 C6 CC 10 CE CE 8E 10 8E	2 2 3 4 3 3 3 3 4	2 2 3 4 3 3 3 3 4	96 D6 DC 10 DE DE 9E 10 9E	4 4 5 6 5 5 6 6 4	2 2 2 3 2 2 2 2 2	A6 E6 EC 10 EE EE AE AE	4+ 4+ 5+ 6+	2+ 2+ 3+	B6 F6 FC 10 FE FE BE 10 BE	5 5 6 7 6 6 6 7 4	3 3 3 4 3 3 3 4 4						M - A M - B M:M + 1 - D M:M + 1 - S M:M + 1 - U M:M + 1 - X M:M + 1 - Y	*	1	1	0	*
LEA	LEAS LEAU LEAX LEAY							32 33 30 31	4+	2+									EA ³ - S EA ³ - U EA ³ - X EA ³ - Y	*	*	*	*	*

LEGEND

OP Operation Code (Hexadecimal)
 - Number of MPU Cycles
 # Number of Program Bytes
 + Arithmetic Plus
 - Arithmetic Minus
 • Multiply

M Complement of M
 - Transfer Into
 H Half-carry (from bit 3)
 N Negative (sign bit)
 Z Zero result
 V Overflow, 2's complement
 C Carry from ALU

! Test and set if true, cleared otherwise
 * Not Affected
 CC Condition Code Register
 : Concatenation
 V Logical or
 A Logical and
 ⊕ Logical Exclusive or

FIGURE 18 – PROGRAMMING AID (CONTINUED)

Instruction	Forms	Addressing Modes												Description	5	3	2	1	0									
		Immediate			Direct			Indexed Modes			Extended				Inherent			H	N	Z	V	C						
		Op	-	/	Op	-	/	Op	-	/	Op	-	/		Op	-	/											
LSL	LSLA																											
	LSLB																											
	LSL				08	6	2		68	6+	2+		78	7	3													
LSR	LSRA																											
	LSRB																											
	LSR				04	6	2		64	6+	2+		74	7	3													
MUL																												
NEG	NEGA																											
	NEGB																											
	NEG				00	6	2		60	6+	2+		70	7	3													
NOP																												
OR	ORA	8A	2	2		9A	4	2	AA	4+	2+	BA	5	3														
	ORB	CA	2	2		DA	4	2	EA	4+	2+	FA	5	3														
	ORCC	1A	3	2																								
PSH	PSHS	34	5+4	2																								
	PSHU	36	5+4	2																								
PUL	PULS	35	5+4	2																								
	PULU	37	5+4	2																								
ROL	ROLA																											
	ROLB																											
	ROL				09	6	2		69	6+	2+		79	7	3													
ROR	RORA																											
	RORB																											
	ROR				06	6	2		66	6+	2+		76	7	3													
RTI																												
RTS																												
SBC	SBCA	82	2	2		92	4	2	A2	4+	2+	B2	5	3														
	SBCB	C2	2	2		D2	4	2	E2	4+	2+	F2	5	3														
SEX																												
ST	STA																											
	STB																											
	STD																											
	STS																											
	STU																											
	STX																											
	STY																											
SUB	SUBA	80	2	2		90	4	2	A0	4+	2+	B0	5	3														
	SUBB	C0	2	2		D0	4	2	E0	4+	2+	F0	5	3														
	SUBD	83	4	3		93	6	2	A3	6+	2+	B3	7	3														
SWI	SWI ⁶																											
	SWI ⁶																											
	SWI ⁶																											
SYNC																												
TFR	R1, R2	1F	6	2																								
TST	TSTA																											
	TSTB																											
	TST				0D	6	2		6D	6+	2+		7D	7	3													

NOTES:

- This column gives a base cycle and byte count. To obtain total count, add the values obtained from the INDEXED ADDRESSING MODE table, Table 2.
- R1 and R2 may be any pair of 8 bit or any pair of 16 bit registers
The 8 bit registers are: A, B, CC, DP
The 16 bit registers are: X, Y, U, S, D, PC
- EA is the effective address.
- The PSH and PUL instructions require 5 cycles plus 1 cycle for each byte pushed or pulled.
- 5(b)l means: 5 cycles if branch not taken, 6 cycles if taken (Branch instructions).
- SWI sets I and F bits. SWI2 and SWI3 do not affect I and F.
- Conditions Codes set as a direct result of the instruction.
- Value of half-carry flag is undefined.
- Special Case – Carry set if b7 is SET.

Branch Instructions

Instruction	Forms	Addressing Mode			Description	5	3	2	1	0
		OP	-	#						
BCC	BCC	24	3	2	Branch C = 0	*	*	*	*	*
	LBCC	10 24	5(6)	4	Long Branch C = 0	*	*	*	*	*
BCS	BCS	25	3	2	Branch C = 1	*	*	*	*	*
	LBCS	10 25	5(6)	4	Long Branch C = 1	*	*	*	*	*
BEQ	BEQ	27	3	2	Branch Z = 1	*	*	*	*	*
	LBEO	10 27	5(6)	4	Long Branch Z = 1	*	*	*	*	*
BGE	BGE	2C	3	2	Branch ≥ Zero	*	*	*	*	*
	LBGE	10 2C	5(6)	4	Long Branch ≥ Zero	*	*	*	*	*
BGT	BGT	2E	3	2	Branch > Zero	*	*	*	*	*
	LBGT	10 2E	5(6)	4	Long Branch > Zero	*	*	*	*	*
BHI	BHI	22	3	2	Branch Higher	*	*	*	*	*
	LBHI	10 22	5(6)	4	Long Branch Higher	*	*	*	*	*
BHS	BHS	24	3	2	Branch Higher or Same	*	*	*	*	*
	LBHS	10 24	5(6)	4	Long Branch Higher or Same	*	*	*	*	*
BLE	BLE	2F	3	2	Branch ≤ Zero	*	*	*	*	*
	LBLE	10 2F	5(6)	4	Long Branch ≤ Zero	*	*	*	*	*
BLO	BLO	25	3	2	Branch lower	*	*	*	*	*
	LBLO	10 25	5(6)	4	Long Branch Lower	*	*	*	*	*

Instruction	Forms	Addressing Mode			Description	5	3	2	1	0
		OP	-	#						
BLS	BLS	23	3	2	Branch Lower or Same	*	*	*	*	*
	LBLS	10 23	5(6)	4	Long Branch Lower or Same	*	*	*	*	*
BLT	BLT	2D	3	2	Branch < Zero	*	*	*	*	*
	LBLT	10 2D	5(6)	4	Long Branch < Zero	*	*	*	*	*
BMI	BMI	2B	3	2	Branch Minus	*	*	*	*	*
	LBMI	10 2B	5(6)	4	Long Branch Minus	*	*	*	*	*
BNE	BNE	26	3	2	Branch Z = 0	*	*	*	*	*
	LBNE	10 26	5(6)	4	Long Branch Z = 0	*	*	*	*	*
BPL	BPL	2A	3	2	Branch Plus	*	*	*	*	*
	LBPL	10 2A	5(6)	4	Long Branch Plus	*	*	*	*	*
BRA	BRA	20	3	2	Branch Always	*	*	*	*	*
	LBRA	16 20	5	3	Long Branch Always	*	*	*	*	*
BRN	BRN	21	3	2	Branch Never	*	*	*	*	*
	LB RN	10 21	5	4	Long Branch Never	*	*	*	*	*
BSR	BSR	8D	7	2	Branch to Subroutine	*	*	*	*	*
	LB SR	17 8D	9	3	Long Branch to Subroutine	*	*	*	*	*
BVC	BVC	28	3	2	Branch V = 0	*	*	*	*	*
	LBVC	10 28	5(6)	4	Long Branch V = 0	*	*	*	*	*
BVS	BVS	29	3	2	Branch V = 1	*	*	*	*	*
	LBVS	10 29	5(6)	4	Long Branch V = 1	*	*	*	*	*

SIMPLE BRANCHES

	OP	~	#
BRA	20	3	2
LBRA	16	5	3
BRN	21	3	2
LBRN	1021	5	4
BSR	8D	7	2
LBSR	17	9	3

SIMPLE CONDITIONAL BRANCHES (Notes 1-4)

Test	True	OP	False	OP
N = 1	BMI	2B	BPL	2A
Z = 1	BEQ	27	BNE	26
V = 1	BVS	29	BVC	28
C = 1	BCS	25	BCC	24

SIGNED CONDITIONAL BRANCHES (Notes 1-4)

Test	True	OP	False	OP
r > m	BGT	2E	BLE	2F
r ≥ m	BGE	2C	BLT	2D
r = m	BEQ	27	BNE	26
r ≤ m	BLE	2F	BGT	2E
r < m	BLT	2D	BGE	2C

UNSIGNED CONDITIONAL BRANCHES (Notes 1-4)

Test	True	OP	False	OP
r > m	BHI	22	BLS	23
r ≥ m	BHS	24	BLO	25
r = m	BEQ	27	BNE	26
r ≤ m	BLS	23	BHI	22
r < m	BLO	25	BHS	24

NOTES:

1. All conditional branches have both short and long variations.
2. All short branches are 2 bytes and require 3 cycles.
3. All conditional long branches are formed by prefixing the short branch opcode with \$10 and using a 16-bit destination offset.
4. All conditional long branches require 4 bytes and 6 cycles if the branch is taken or 5 cycles if the branch is not taken.
5. 5(6) means: 5 cycles if branch not taken, 6 cycles if taken.

INDEXED ADDRESSING MODES

Type	Forms	Nondirect			Indirect		
		Assembler Form	Post-Byte Opcode	+ - #	Assembler Form	Post-Byte Opcode	+ - #
Constant Offset From R	No Offset	. R	1RR00100	0 0	[, R]	1RR10100	3 0
	5-Bit Offset	n, R	0RRnnnnn	1 0	defaults to 8-bit		
	8-Bit Offset	n, R	1RR01000	1 1	[n, R]	1RR11000	4 1
	16-Bit Offset	n, R	1RR01001	4 2	[n, R]	1RR11001	7 2
Accumulator Offset From R	A - Register Offset	A, R	1RR0110	1 0	[A, R]	1RR10110	4 0
	B - Register Offset	B, R	1RR0101	1 0	[B, R]	1RR10101	4 0
	D - Register Offset	D, R	1RR01011	4 0	[D, R]	1RR11011	7 0
Auto Increment/Decrement R	Increment By 1	. R +	1RR00000	2 0	not allowed		
	Increment By 2	. R ++	1RR00001	3 0	[, R ++]	1RR10001	6 0
	Decrement By 1	. - R	1RR00010	2 0	not allowed		
	Decrement By 2	. - - R	1RR00011	3 0	[, - - R]	1RR10011	6 0
Constant Offset From PC	8-Bit Offset	n, PCR	1XX01100	1 1	[n, PCR]	1XX11100	4 1
	16-Bit Offset	n, PCR	1XX01101	5 2	[n, PCR]	1XX11101	8 2
Extended Indirect	16-Bit Address	-	-	-	[n]	10011111	5 2

R = X, Y, U, or S
X = Don't Care

RR: 00 = X 10 = U
01 = Y 11 = S

INDEXED ADDRESSING POSTBYTE REGISTER BIT ASSIGNMENTS

Post-Byte Register Bit	Indexed Addressing Mode
7 6 5 4 3 2 1 0	
0 R R x x x x x	EA = , R + 5 Bit Offset
1 R R 0 0 0 0 0	. R +
1 R R 1 0 0 0 0	. R ++
1 R R 0 0 0 0 1	. - R
1 R R 1 0 0 0 1	. - - R
1 R R 1 0 1 0 0	EA = , R + 0 Offset
1 R R 1 0 1 0 1	EA = , R + ACCB Offset
1 R R 1 0 1 1 0	EA = , R + ACCA Offset
1 R R 1 1 0 0 0	EA = , R + 8-Bit Offset
1 R R 1 1 0 0 1	EA = , R + 16-Bit Offset
1 R R 1 1 0 1 1	EA = , R + D Offset
1 x x 1 1 1 0 0	EA = , PC + 8-Bit Offset
1 x x 1 1 1 0 1	EA = , PC + 16-Bit Offset
1 R R 1 1 1 1 1	EA = [, Address]

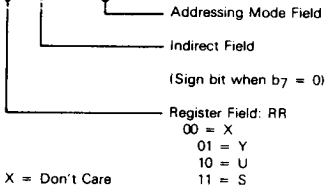

8809 PROGRAMMING MODEL

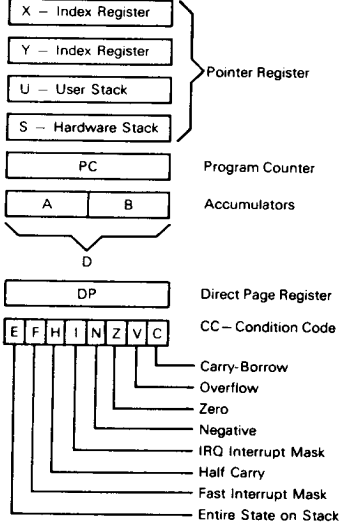

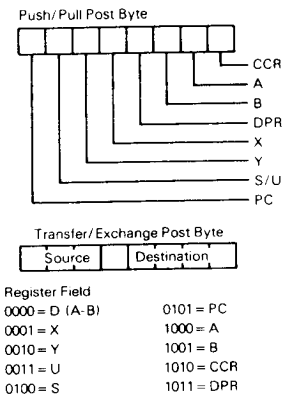

6809 Stacking Order

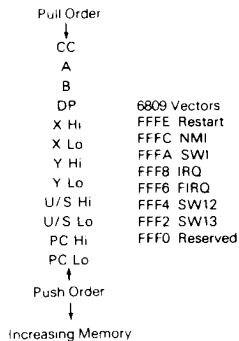

ORDERING INFORMATION

EF68A09E C M B/B												
Device							Screening level					
Package							Oper. temp.					
The table below horizontally shows all available suffix combinations for package, operating temperature and screening level. Other possibilities on request.												
DEVICE	PACKAGE					OPER. TEMP			SCREENING LEVEL			
	C	J	P	E	FN	L*	V	M	Std	D	G/B	B/B
EF6809E (1.0 MHz)	•	•	•		•	•			•			
	•	•					•		•		•	•
	•	•						•	•		•	
EF68A09E (1.5 MHz)	•	•	•			•			•			
	•	•					•		•			
	•	•						•	•		•	•
EF68B09E (2.0 MHz)	•	•	•			•			•			
	•	•					•		•		•	
Examples: EF6809EC, EF6809ECV, EF6809ECM												
Package: C: Ceramic DIL, J: Cerdip DIL, P: Plastic DIL, E: LCCC, FN: PLCC. Oper. temp.: L*: 0°C to +70°C, V: -40°C to +85°C, M: -55°C to +125°C, * : may be omitted. Screening level: Std: (no-end suffix), D: NFC 96883 level D, G/B: NFC 96883 level G, B/B: NFC 96883 level B and MIL-STD-883C level B.												

PHYSICAL DIMENSIONS

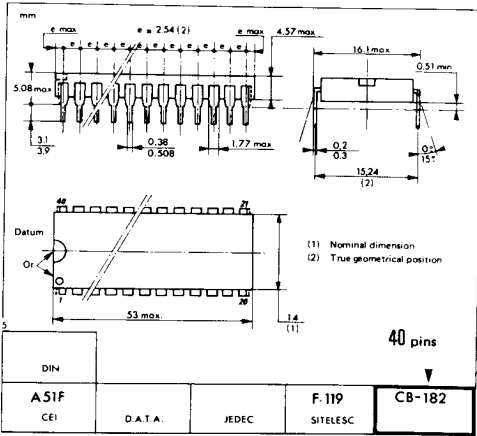

CB-182

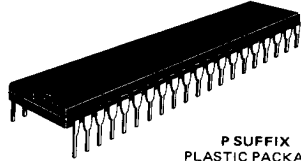

P SUFFIX
PLASTIC PACKAGE

ALSO AVAILABLE

J SUFFIX
CERDIP PACKAGE

C SUFFIX
CERAMIC PACKAGE

CB-521



FN SUFFIX
PLCC 44

