

OBSOLETE PRODUCT
See HA-2540 or HA-2850

600MHz, Very High Slew Rate Operational Amplifier

The HA-2840 is a wideband, very high slew rate, operational amplifier featuring superior speed and bandwidth characteristics. Bipolar construction, coupled with dielectric isolation, delivers outstanding performance in circuits with a closed loop gain of 10 or greater.

A 625V/μs slew rate and a 600MHz gain bandwidth product ensure high performance in video and RF amplifier designs. Differential gain and phase are a low 0.03% and 0.03 degrees respectively, making the HA-2840 ideal for video applications. A full ±10V output swing, high open loop gain, and outstanding AC parameters, make the HA-2840 an excellent choice for high speed Data Acquisition Systems.

The HA-2840 is available in commercial and industrial temperature ranges, and a choice of packages. See the "Ordering Information" below for more information. For military grade product, refer to the HA-2840/883 data sheet.

Part Number Information

PART NUMBER (BRAND)	TEMP. RANGE (°C)	PACKAGE	PKG. NO.
HA3B2840-5	0 to 75	14 Ld PDIP	E14.3
HA3-2840-5	0 to 75	8 Ld PDIP	E8.3
HA9P2840-5 (H28405)	0 to 75	8 Ld SOIC	M8.15
HA3B2840-9	-40 to 85	14 Ld PDIP	E14.3
HA7-2840-9	-40 to 85	8 Ld CERDIP	F8.3A
HA3-2840-9	-40 to 85	8 Ld PDIP	E8.3

Features

- Low Supply Current 13mA
- Very High Slew Rate 625V/μs
- Open Loop Gain 25kV/V
- Wide Gain-Bandwidth ($A_{V} \geq 10$) 600MHz
- Full Power Bandwidth 10MHz
- Low Offset Voltage 0.6mV
- Differential Gain/Phase 0.03%/0.03 Degrees
- Enhanced Replacement for EL2039

Applications

- Pulse and Video Amplifiers
- Wideband Amplifiers
- High Speed Sample-Hold Circuits
- RF Oscillators

Pinouts

HA-2840 (CERDIP, PDIP, SOIC) TOP VIEW

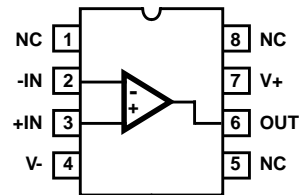

HA-2840 (PDIP) TOP VIEW

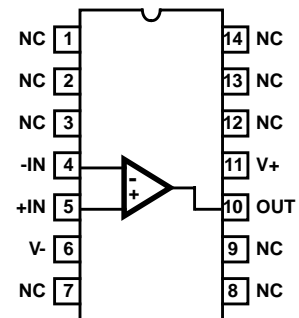

NOTE: No Connection (NC) pins may be tied to a ground plane for better isolation and heat dissipation.

HA-2840

Absolute Maximum Ratings

Voltage Between V+ and V- Terminals	35V
Differential Input Voltage	6V
Output Current	50mA

Operating Conditions

Temperature Range	
HA-2840-5	0°C to 75°C
HA-2840-9	-40°C to 85°C
Recommended Supply Voltage Range	±7V to ±15V

Thermal Information

Thermal Resistance (Typical, Note 2)	θ_{JA} (°C/W)	θ_{JC} (°C/W)
14 Lead PDIP Package	80	N/A
8 Lead CERDIP Package	135	50
8 Lead PDIP Package	96	N/A
8 Lead SOIC Package	157	N/A
Maximum Internal Quiescent Power Dissipation (Note 1)		
Maximum Junction Temperature (Ceramic Package)	175°C	
Maximum Junction Temperature (Plastic Package)	150°C	
Maximum Storage Temperature Range	-65°C to 150°C	
Maximum Lead Temperature (Soldering 10s)	300°C	
(SOIC - Lead Tips Only)		

CAUTION: Stresses above those listed in "Absolute Maximum Ratings" may cause permanent damage to the device. This is a stress only rating and operation of the device at these or any other conditions above those indicated in the operational sections of this specification is not implied.

NOTES:

- Maximum power dissipation with load conditions must be designed to maintain the maximum junction temperature below 175°C for ceramic packages and below 150°C for plastic packages.
- θ_{JA} is measured with the component mounted on an evaluation PC board in free air.

Electrical Specifications $V_{SUPPLY} = \pm 15V, R_L = 1k\Omega, C_L \leq 10pF$, Unless Otherwise Specified

PARAMETER	TEST CONDITIONS	TEMP (°C)	HA-2840-5, -9			UNITS
			MIN	TYP	MAX	
INPUT CHARACTERISTICS						
Offset Voltage (Note 8)		25	-	0.6	2	mV
		Full	-	2	6	mV
Average Offset Voltage Drift		Full	-	20	-	$\mu V/^\circ C$
Bias Current (Note 8)		25	-	5	14.5	μA
		Full	-	8	20	μA
Offset Current		25	-	1	4	μA
		Full	-	-	8	μA
Input Resistance		25	-	10	-	k Ω
Input Capacitance		25	-	1	-	pF
Common Mode Range		Full	±10	-	-	V
Input Noise Voltage (Note 8)	f = 1kHz, R _{SOURCE} = 0 Ω	25	-	6	-	nV/ \sqrt{Hz}
Input Noise Current (Note 8)	f = 1kHz, R _{SOURCE} = 10k Ω	25	-	6	-	pA/ \sqrt{Hz}
TRANSFER CHARACTERISTICS						
Large Signal Voltage Gain	Note 3	25	20	25	-	kV/V
		Full	15	20	-	kV/V
Common-Mode Rejection Ratio (Note 8)	V _{CM} = ±10V	Full	75	80	-	dB
Minimum Stable Gain		25	10	-	-	V/V
Gain Bandwidth Product (Note 8)	V _O = 90mV, A _V = +100	25	-	600	-	MHz
OUTPUT CHARACTERISTICS						
Output Voltage Swing (Note 8)	Note 3	Full	±10	-	-	V
Output Current (Note 8)	Note 3	Full	±10	±20	-	mA
Output Resistance		25	-	30	-	Ω
Full Power Bandwidth (Note 4)	Note 3	25	8.7	10	-	MHz
Differential Gain (Note 7)	A _V = 10	25	-	0.03	-	%

HA-2840

Electrical Specifications $V_{SUPPLY} = \pm 15V$, $R_L = 1k\Omega$, $C_L \leq 10pF$, Unless Otherwise Specified (Continued)

PARAMETER	TEST CONDITIONS	TEMP (°C)	HA-2840-5, -9			UNITS
			MIN	TYP	MAX	
Differential Phase (Note 7)	$A_V = 10$	25	-	0.03	-	Degrees
Harmonic Distortion (Note 8)	$A_V = 10$, $V_O = 2V_{P-P}$, $f = 1MHz$	25	-	-79	-	dBc
TRANSIENT RESPONSE (Note 5)						
Rise Time		25	-	4	-	ns
Overshoot		25	-	20	-	%
Slew Rate (Notes 6, 8)	Note 3	25	550	625	-	V/ μs
Settling Time	10V Step to 0.1%	25	-	180	-	ns
POWER REQUIREMENTS						
Supply Current (Note 8)		Full	-	13	15	mA
Power Supply Rejection Ratio (Note 8)	$V_S = \pm 10V$ to $\pm 20V$	Full	75	90	-	dB

NOTES:

- $R_L = 1k\Omega$, $V_O = \pm 10V$, $0V$ to $\pm 10V$ for slew rate.
- Full Power Bandwidth guaranteed based on slew rate measurement using: $FPBW = \frac{\text{Slew Rate}}{2\pi V_{PEAK}}$; ($V_{PEAK} = 10V$).
- Refer to Test Circuit section of data sheet.
- This parameter is not tested. The limits are guaranteed based on lab characterization, and reflect lot-to-lot variation.
- Differential gain and phase are measured with a VM700A video tester, using a NTC-7 composite VITS.
- See "Typical Performance Curves" for more information.

Test Circuits and Waveforms

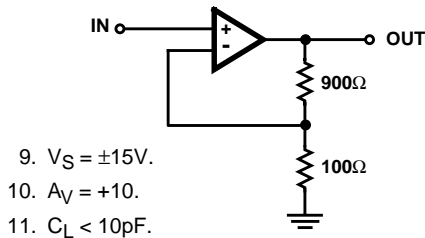

TEST CIRCUIT

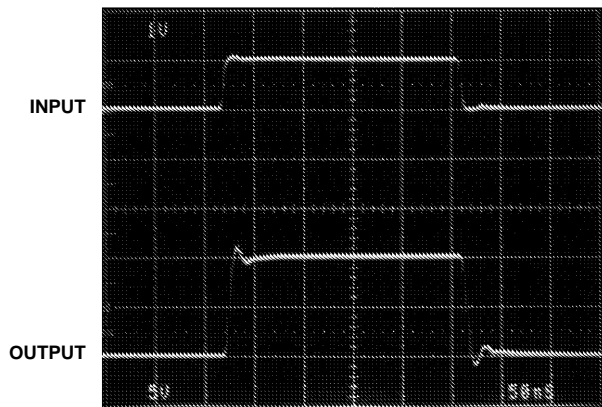

Input = 1V/Div.
 Output = 5V/Div.
 50ns/Div.

LARGE SIGNAL RESPONSE

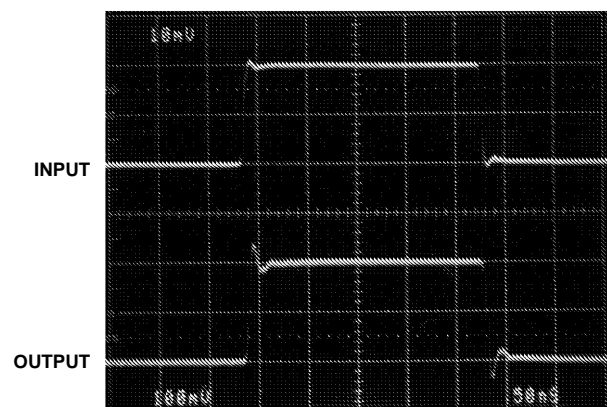

Input = 10mV/Div.
 Output = 100mV/Div.
 50ns/Div.

SMALL SIGNAL RESPONSE

Test Circuits and Waveforms (Continued)

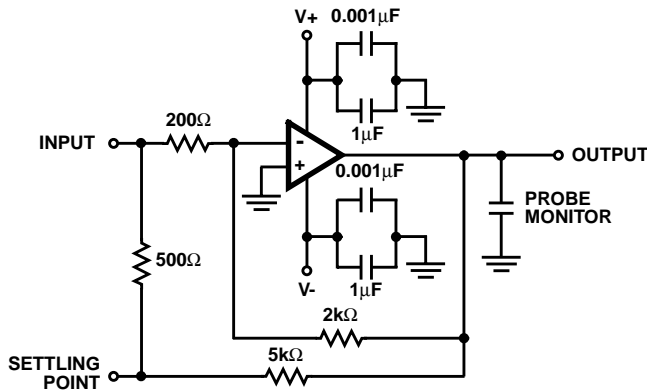

NOTES:

12. $A_V = -10$.
13. Load Capacitance should be less than 10pF.
14. It is recommended that resistors be carbon composition and that feedback and summing network ratios be matched to 0.1%.
15. SETTLING POINT (Summing Node) capacitance should be less than 10pF. For optimum settling time results, it is recommended that the test circuit be constructed directly onto the device pins. A Tektronix 568 Sampling Oscilloscope with S-3A sampling heads is recommended as a settle point monitor.

SETTLING TIME TEST CIRCUIT

Typical Performance Curves $T_A = 25^\circ\text{C}$, $V_{\text{SUPPLY}} = \pm 15\text{V}$, $R_L = 1\text{k}\Omega$, $C_L < 10\text{pF}$, Unless Otherwise Specified

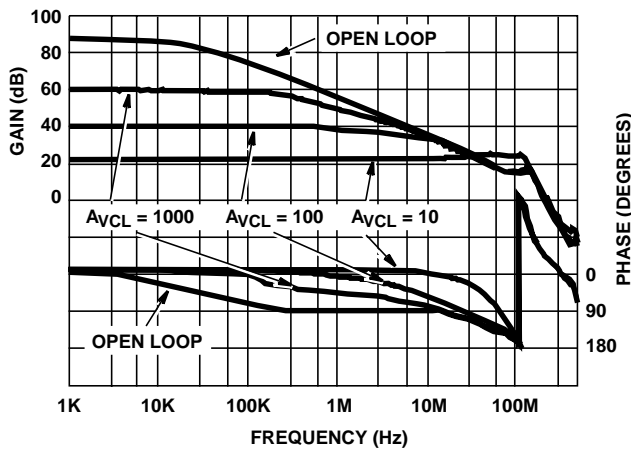

FIGURE 1. FREQUENCY RESPONSE FOR VARIOUS GAINS

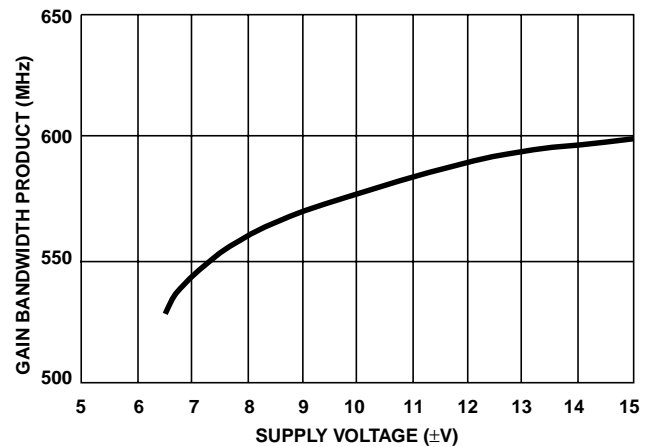

FIGURE 2. GAIN BANDWIDTH PRODUCT vs SUPPLY VOLTAGE

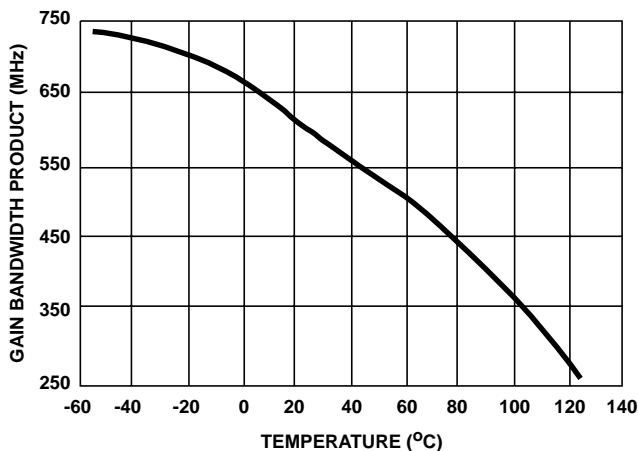

FIGURE 3. GAIN BANDWIDTH PRODUCT vs TEMPERATURE

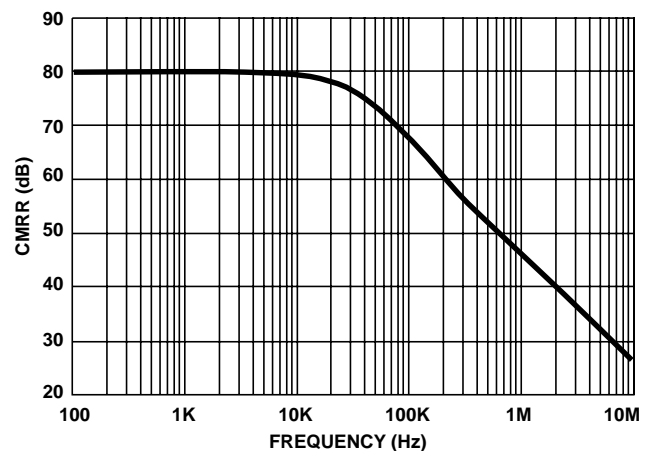

FIGURE 4. CMRR vs FREQUENCY

Typical Performance Curves $T_A = 25^\circ\text{C}$, $V_{\text{SUPPLY}} = \pm 15\text{V}$, $R_L = 1\text{k}\Omega$, $C_L < 10\text{pF}$, Unless Otherwise Specified (Continued)

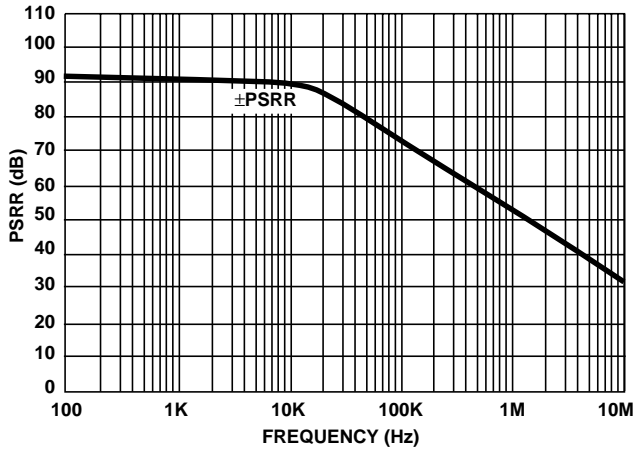

FIGURE 5. PSRR vs FREQUENCY

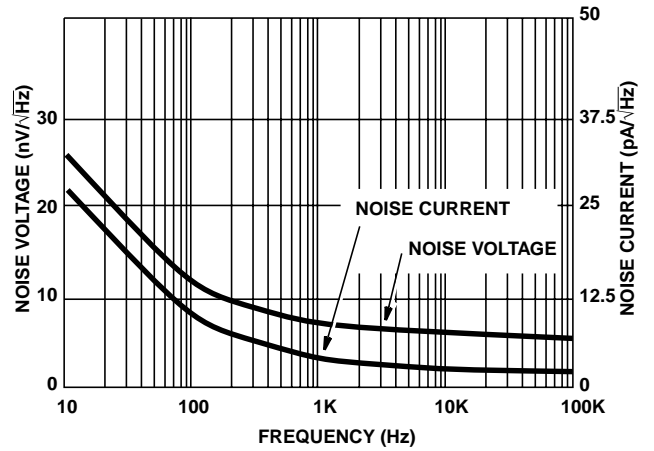

FIGURE 6. INPUT NOISE vs FREQUENCY

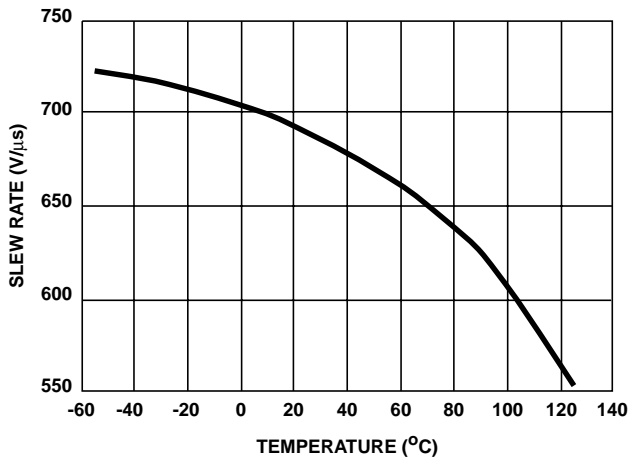

FIGURE 7. SLEW RATE vs TEMPERATURE

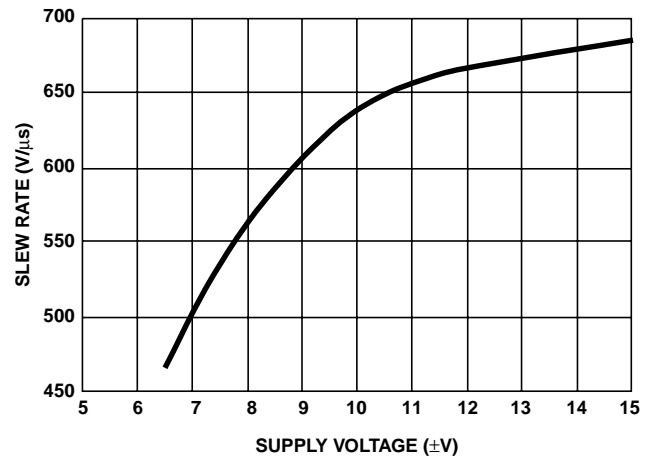

FIGURE 8. SLEW RATE vs SUPPLY VOLTAGE

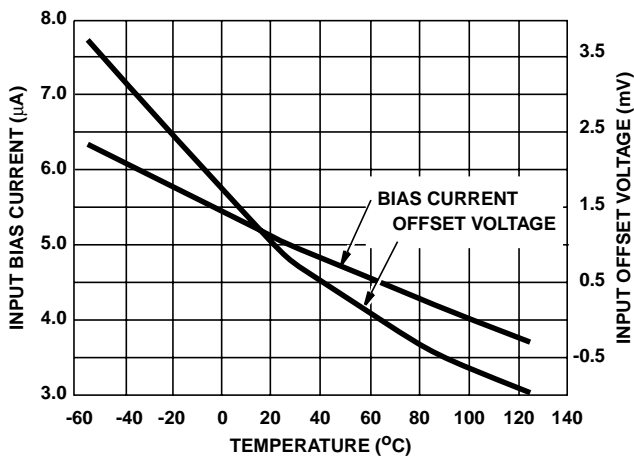

FIGURE 9. INPUT OFFSET VOLTAGE AND INPUT BIAS CURRENT vs TEMPERATURE

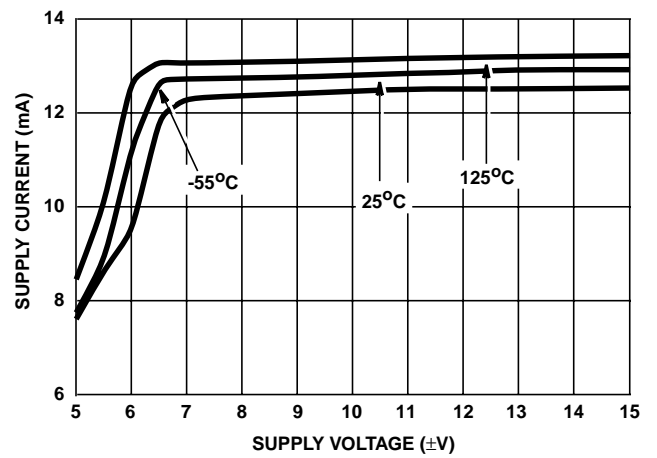

FIGURE 10. SUPPLY CURRENT vs SUPPLY VOLTAGE

Typical Performance Curves $T_A = 25^\circ\text{C}$, $V_{\text{SUPPLY}} = \pm 15\text{V}$, $R_L = 1\text{k}\Omega$, $C_L < 10\text{pF}$, Unless Otherwise Specified (Continued)

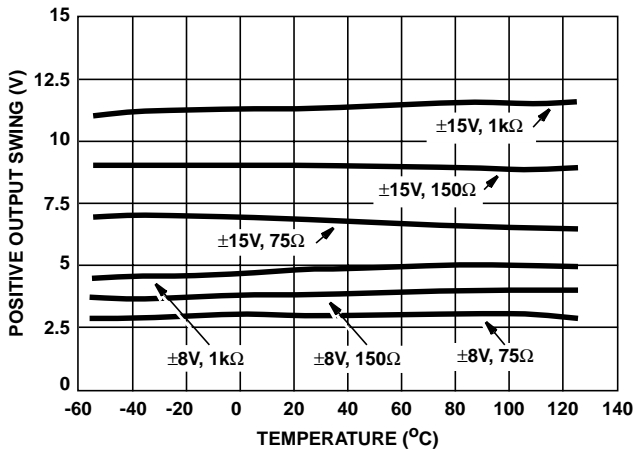

FIGURE 11. POSITIVE OUTPUT SWING vs TEMPERATURE

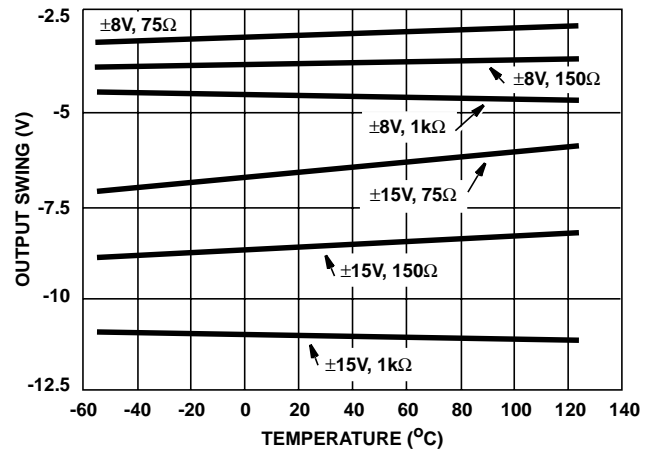

FIGURE 12. NEGATIVE OUTPUT SWING vs TEMPERATURE

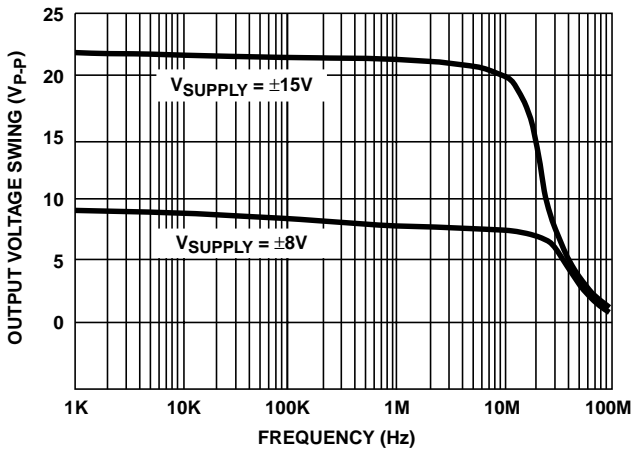

FIGURE 13. MAXIMUM UNDISTORTED OUTPUT SWING vs FREQUENCY

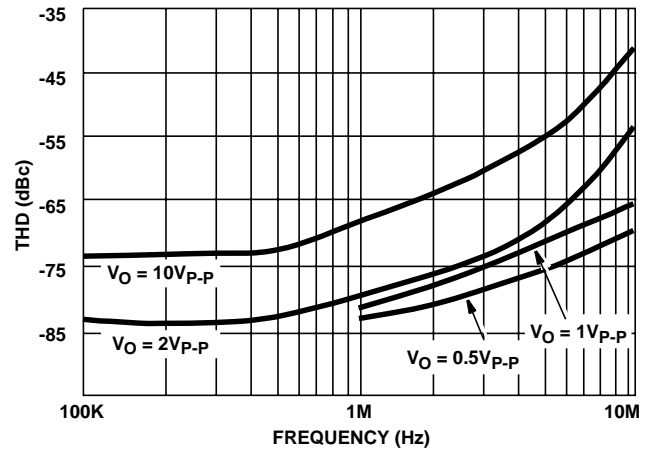

FIGURE 14. TOTAL HARMONIC DISTORTION vs FREQUENCY

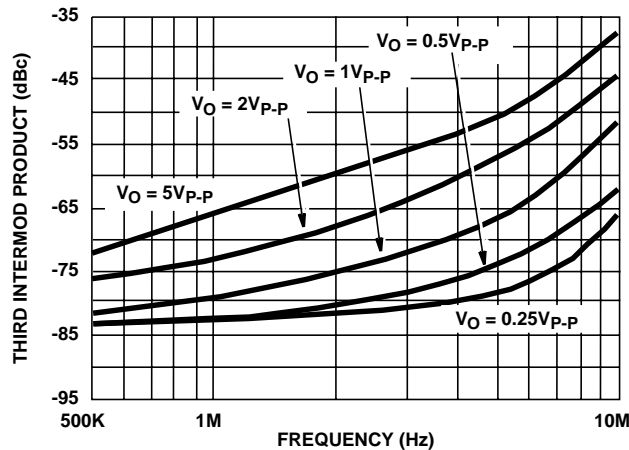

FIGURE 15. INTERMODULATION DISTORTION vs FREQUENCY (TWO TONE)

Die Characteristics

DIE DIMENSIONS:

65 mils x 52 mils x 19 mils
1650 μ m x 1310 μ m x 483 μ m

METALLIZATION:

Type: Aluminum, 1% Copper
Thickness: 16k Å \pm 2k Å

PASSIVATION:

Type: Nitride over Silox
Silox Thickness: 12k Å \pm 2k Å
Nitride thickness: 3.5k Å \pm 1k Å

SUBSTRATE POTENTIAL (Powered Up):

V-

TRANSISTOR COUNT:

34

PROCESS:

High Frequency Bipolar Dielectric Isolation

Metallization Mask Layout

HA-2840

