

SHINDENGEN

Schottky Rectifiers (SBD)

Dual

SF15SC4

40V 15A

OUTLINE DIMENSIONS

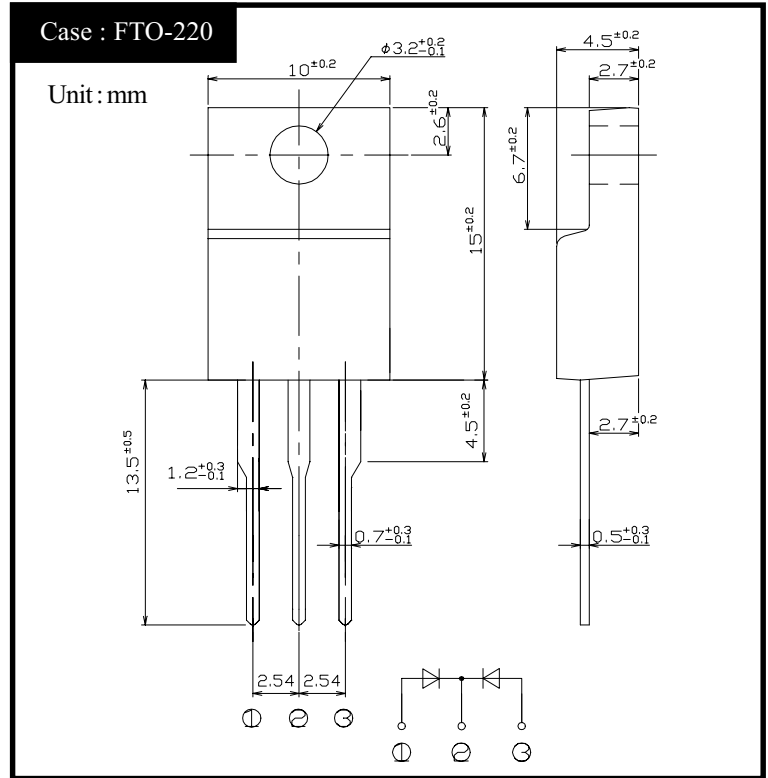

RATINGS

● Absolute Maximum Ratings (Unless otherwise specified, $T_c=25^\circ\text{C}$)

Item	Symbol	Conditions	Ratings	Unit
Storage Temperature	T_{stg}		-55~150	$^\circ\text{C}$
Operating Junction Temperature	T_j		150	$^\circ\text{C}$
Maximum Reverse Voltage	V_{RM}		40	V
Repetitive Peak Surge Reverse Voltage	V_{RRSM}	Pulse width 0.5ms, duty 1/40	45	V
Average Rectified Forward Current	I_O	50Hz sine wave, R-load, Rating for each diode $I_o/2$, $T_c=125^\circ\text{C}$	15	A
Peak Surge Forward Current	I_{FSM}	50Hz sine wave, Non-repetitive 1 cycle peak value, $T_j=25^\circ\text{C}$	200	A
Repetitive Peak Surge Reverse Power	P_{RRSM}	Pulse width 10 μs , Rating of per diode, $T_j=25^\circ\text{C}$	330	W
Dielectric Strength	V_{dis}	Terminals to case, AC 1 minute	2	kV
Mounting Torque	TOR	(Recommended torque: 0.3N·m)	0.5	N·m

● Electrical Characteristics (Unless otherwise specified, $T_c=25^\circ\text{C}$)

Item	Symbol	Conditions	Ratings	Unit
Forward Voltage	V_F	$I_F=7.5\text{A}$, Pulse measurement, Rating of per diode	Max 0.55	V
Reverse Current	I_R	$V_R=V_{RM}$, Pulse measurement, Rating of per diode	Max 5.0	mA
Junction Capacitance	C_j	$f=1\text{MHz}$, $V_R=10\text{V}$, Rating of per diode	Typ 340	pF
Thermal Resistance	θ_{jc}	junction to case	Max 2.0	$^\circ\text{C/W}$
	θ_{jf}	junction to heatsink	Max 4.5	$^\circ\text{C/W}$
	θ_{cf}	case to heatsink	Max 2.5	$^\circ\text{C/W}$

SF15SC4 Forward Voltage

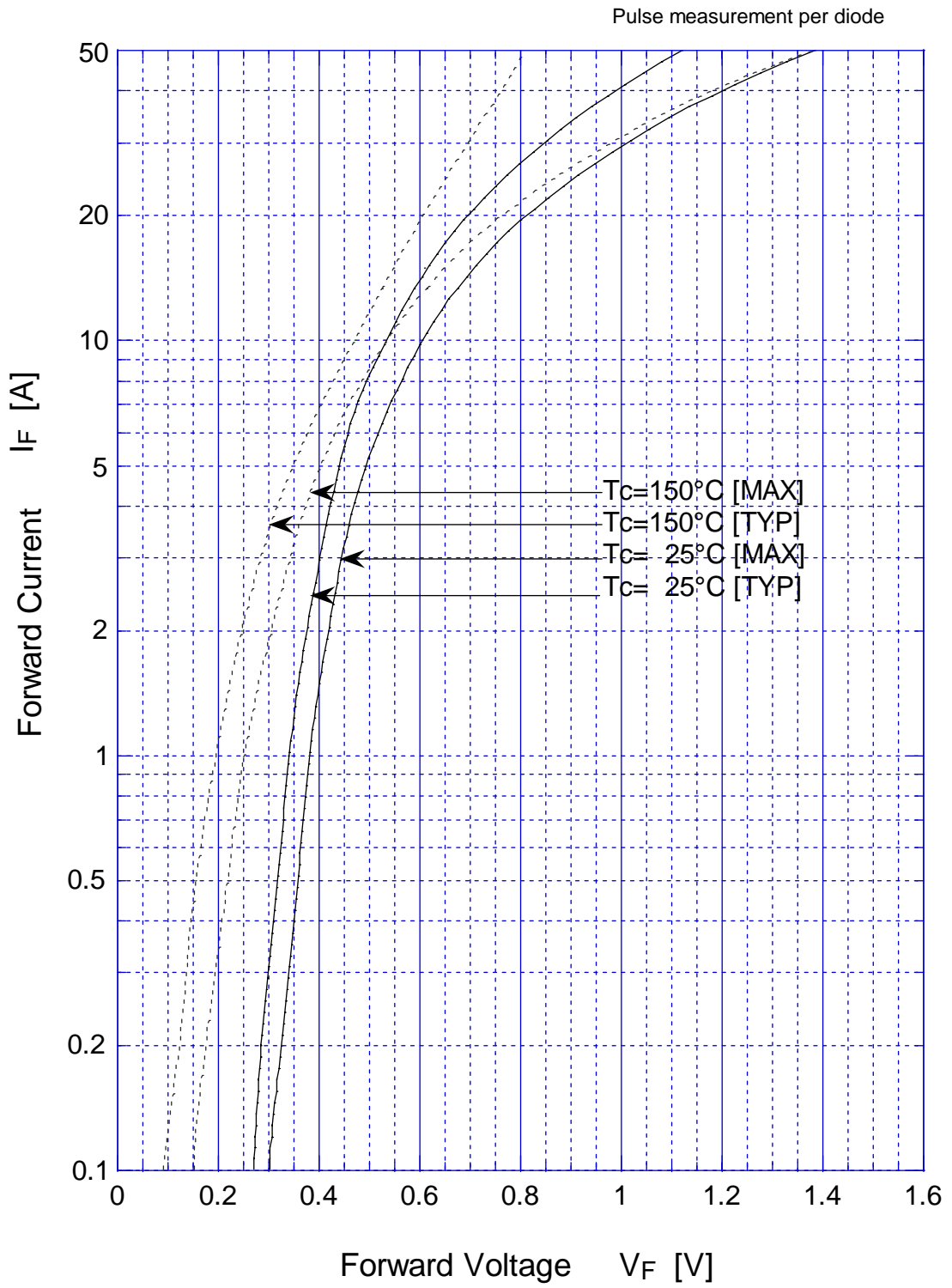

SF15SC4 Reverse Current

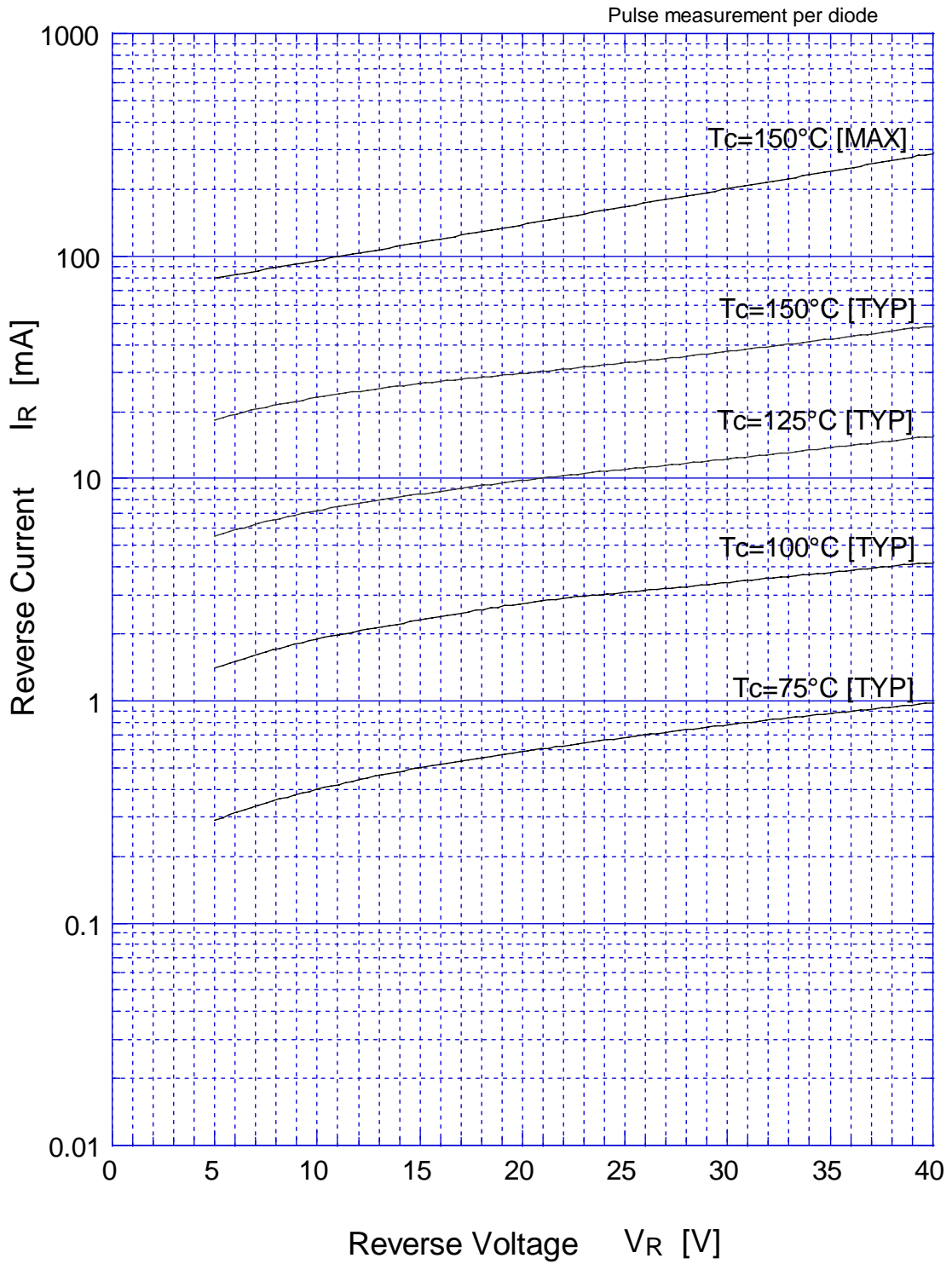

SF15SC4 Forward Power Dissipation

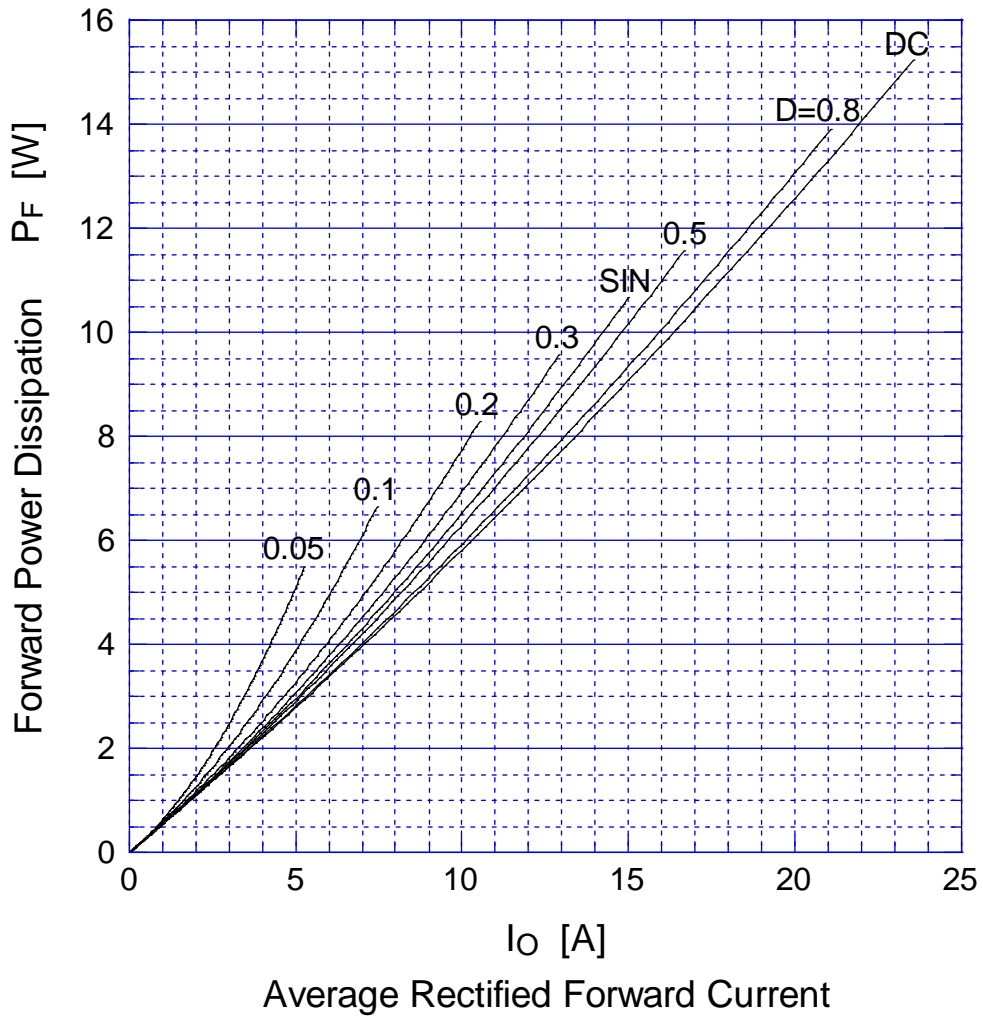

$T_j = 150^\circ\text{C}$

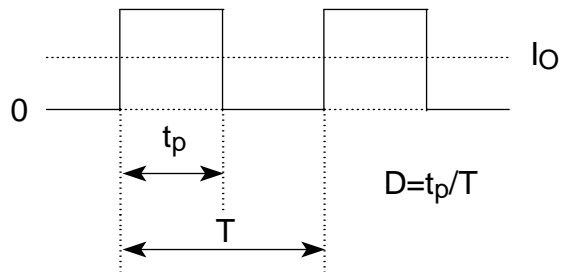

SF15SC4 Reverse Power Dissipation

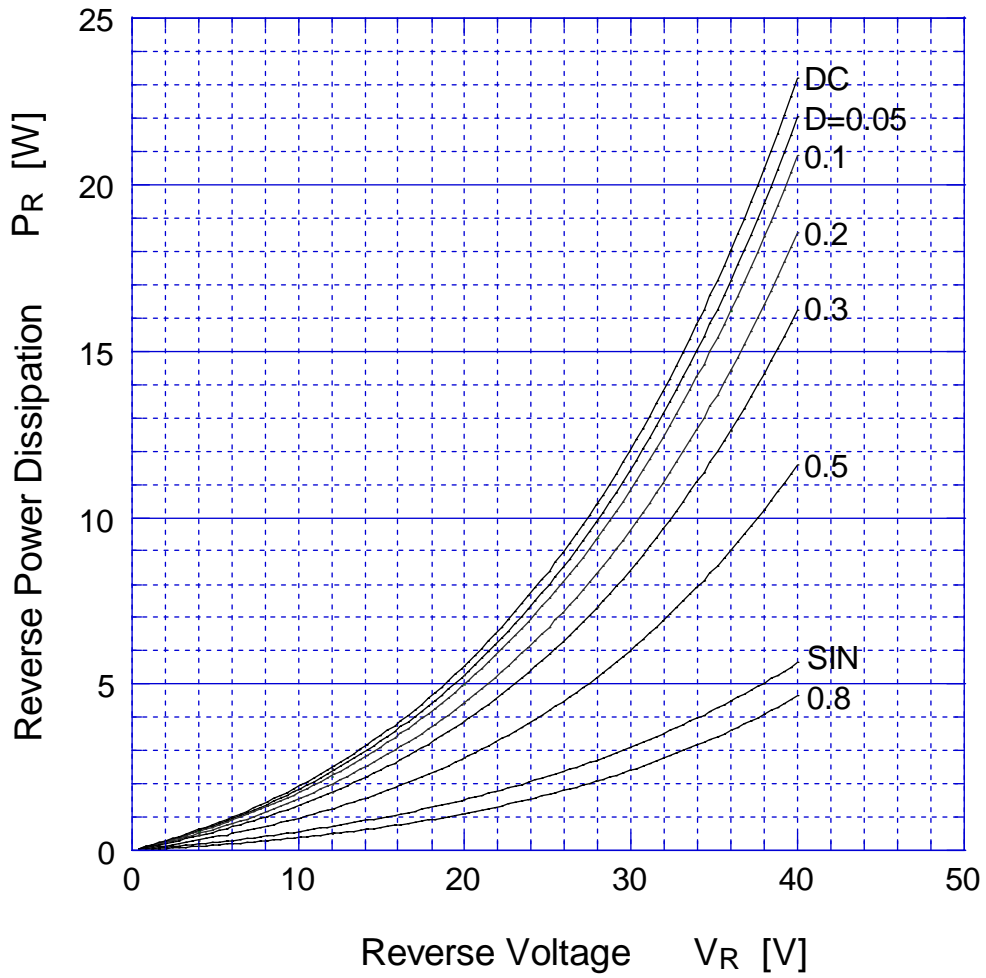

$T_j = 150^\circ\text{C}$

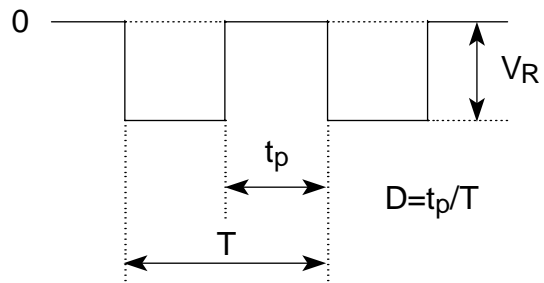

SF15SC4

Derating Curve

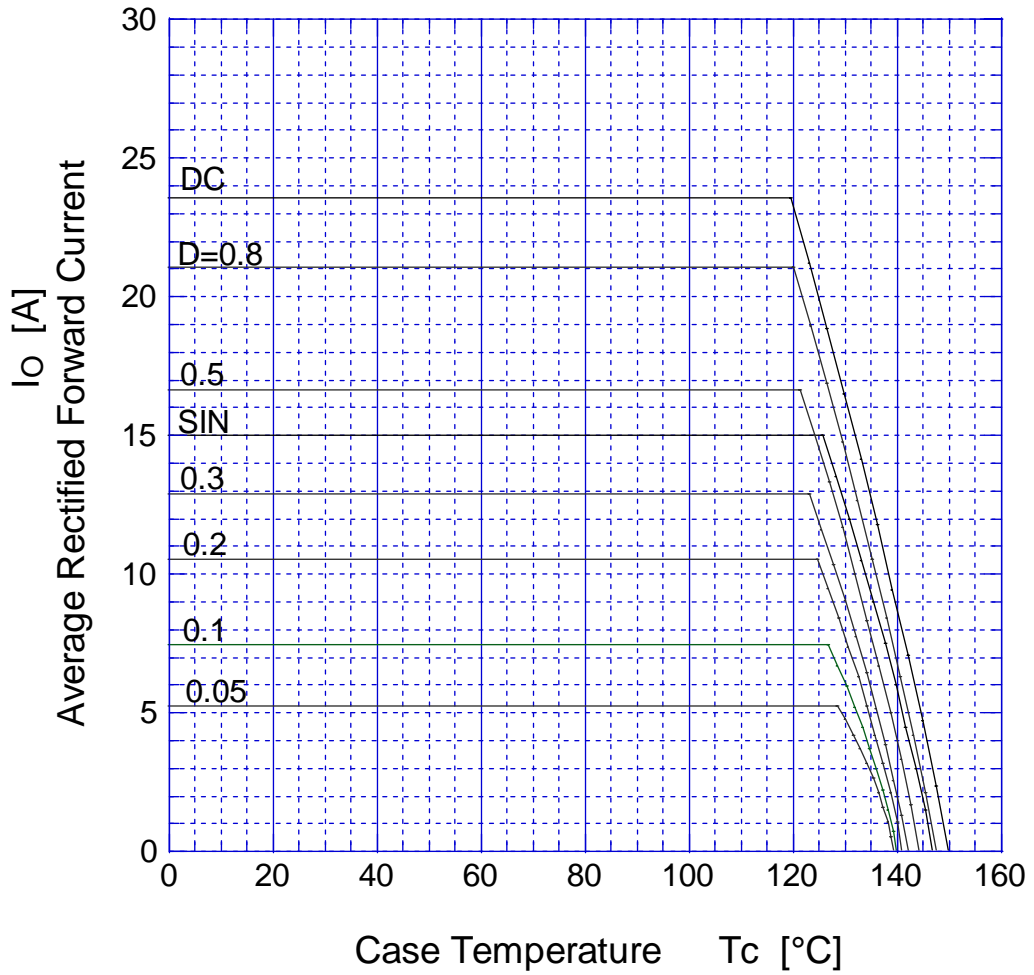

$V_R = 20V$

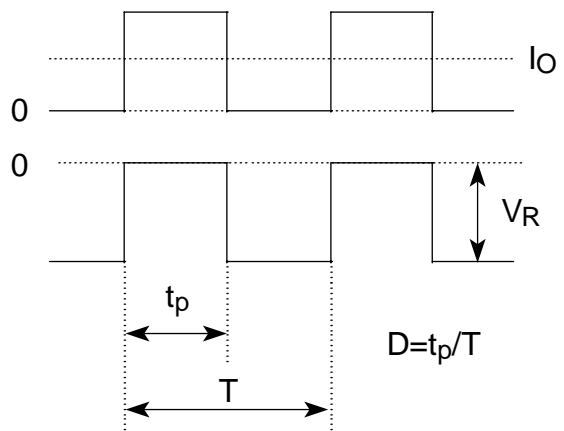

SF15SC4 Peak Surge Forward Capability

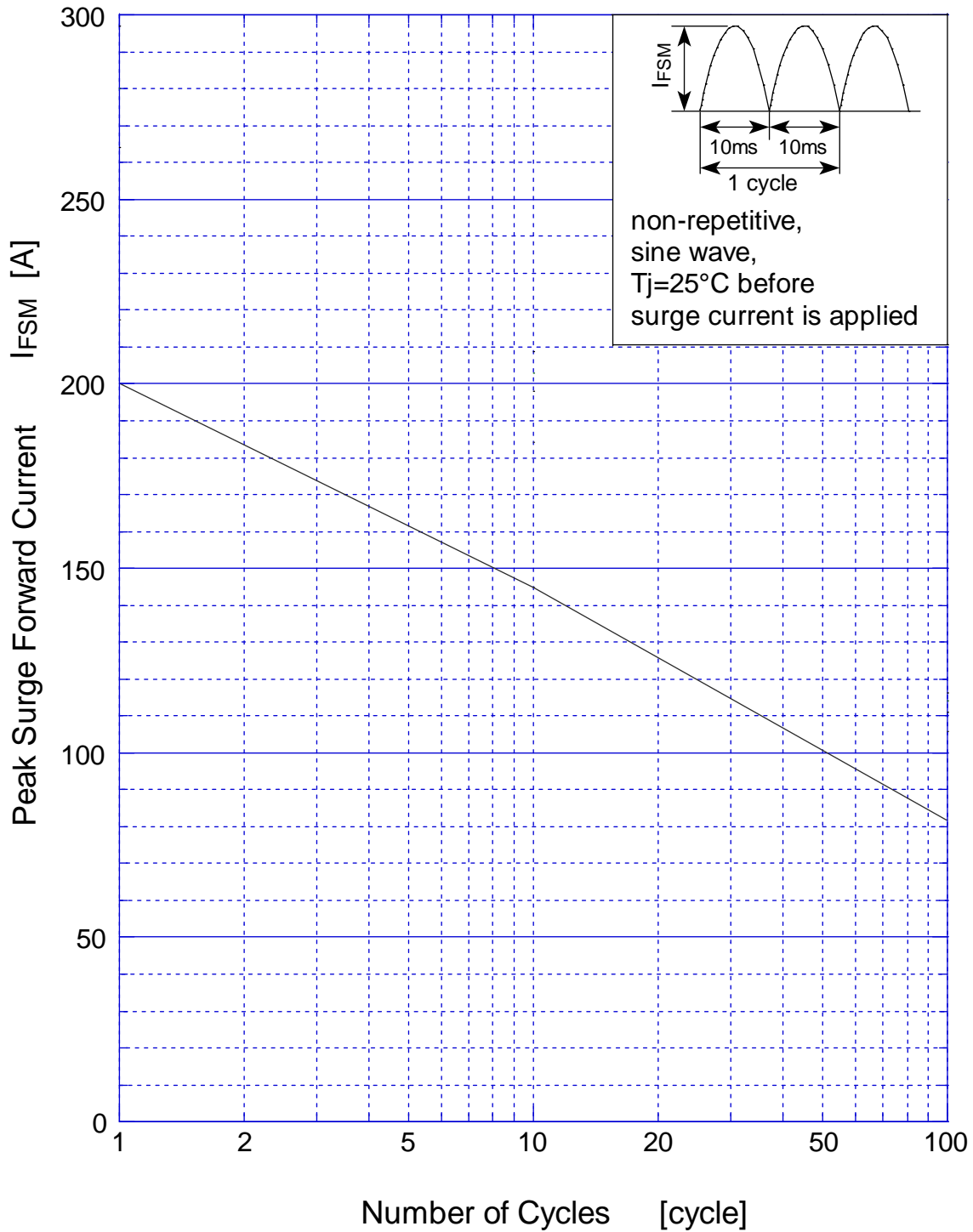

SF15SC4 Junction Capacity

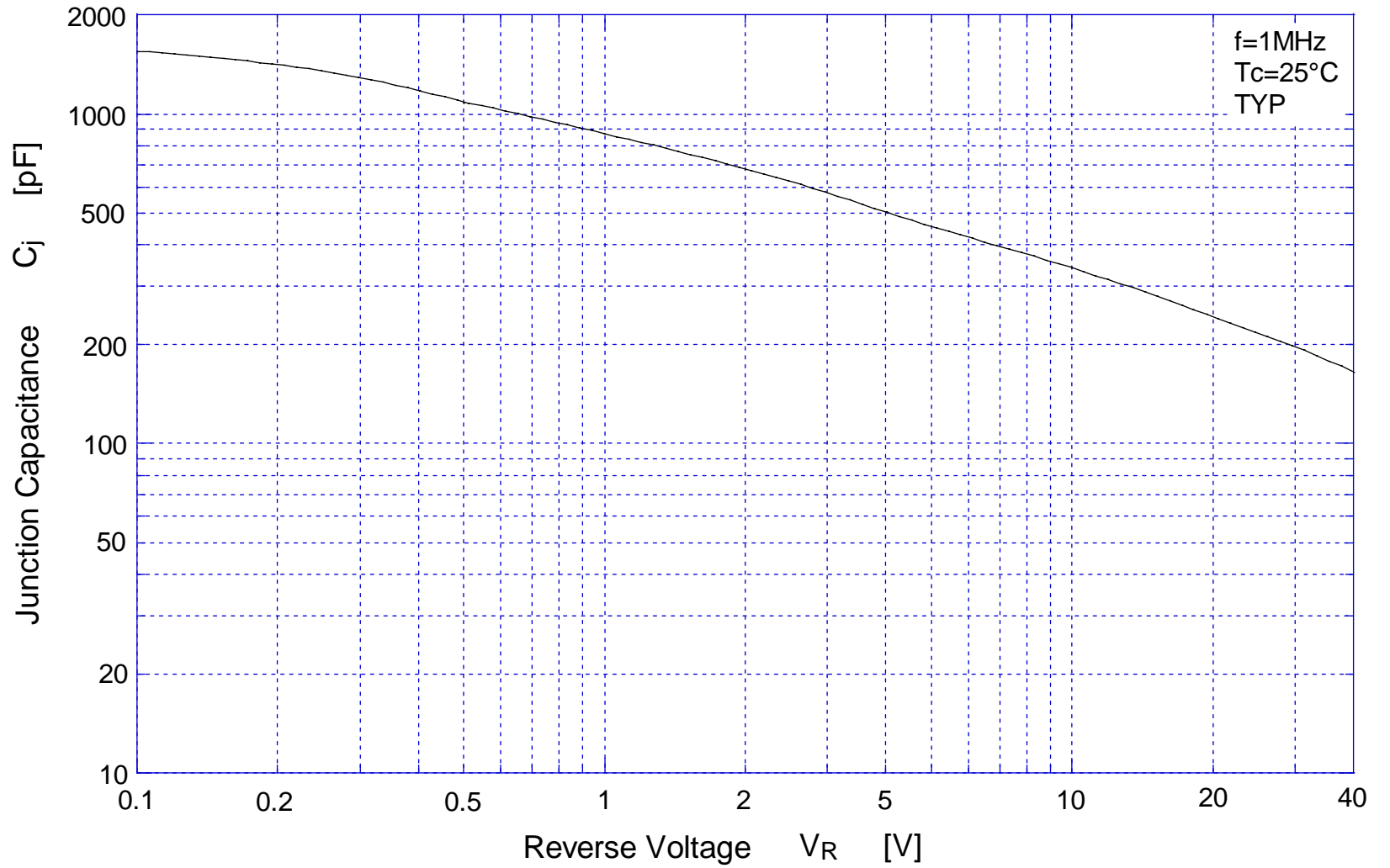

SF15SC4 Repetitive Surge Reverse Power Capability

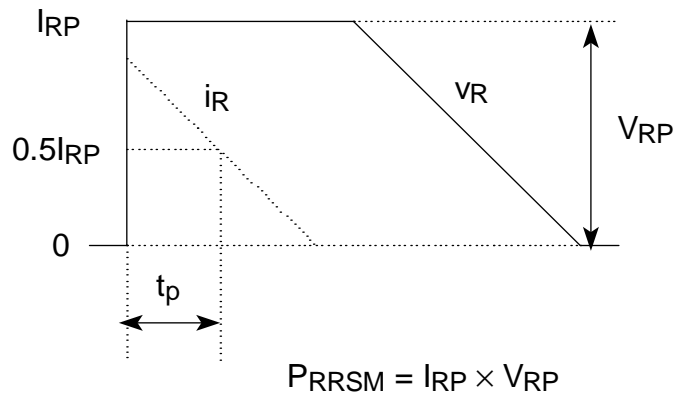
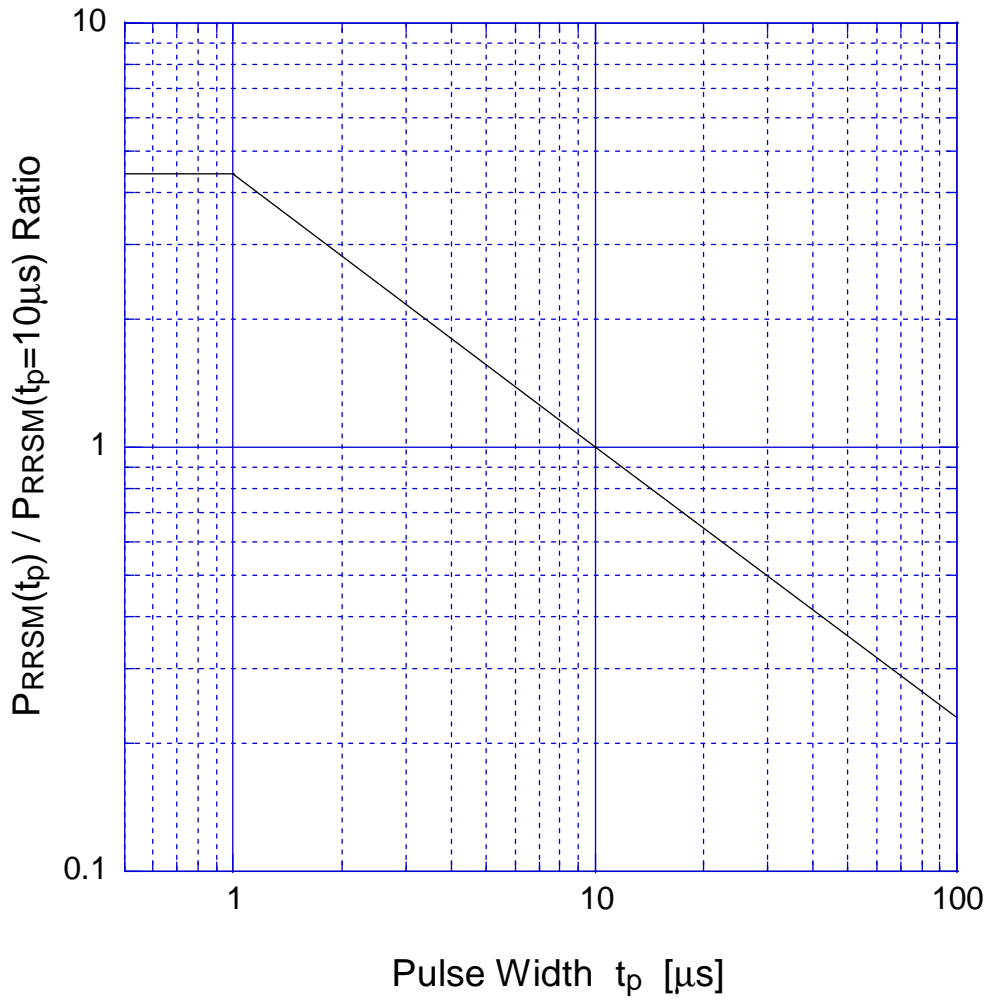

SF15SC4 Repetitive Surge Reverse Power Derating Curve

