

BIPOLAR ANALOG INTEGRATED CIRCUIT

μ PC3533,3504

THREE-THERMAL POSITIVE OUTPUT VOLTAGE

DESCRIPTION

The μ PC3533 and 3504 are three-thermal positive output voltage regulators with an output current of 1 A at respective output voltages of 3.3 and 4 V. These regulators are guaranteed to operate at as low as -40°C .

FEATURES

- Output current capacity: 1 A
- On-chip overcurrent limiter
- On-chip output transistor safe operation area protection
- On-chip thermal protection
- Output capacitor capacitance: 0.1 μF or higher
- Wide operating temperature range: $T_A = -40$ to $+85^{\circ}\text{C}$

PIN CONFIGURATION (Marking Side)

μ PC3533HF, 3504HF: MP-45G

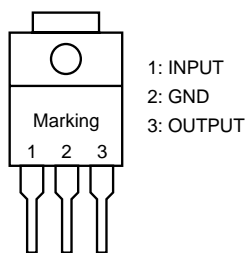

BLOCK DIAGRAM

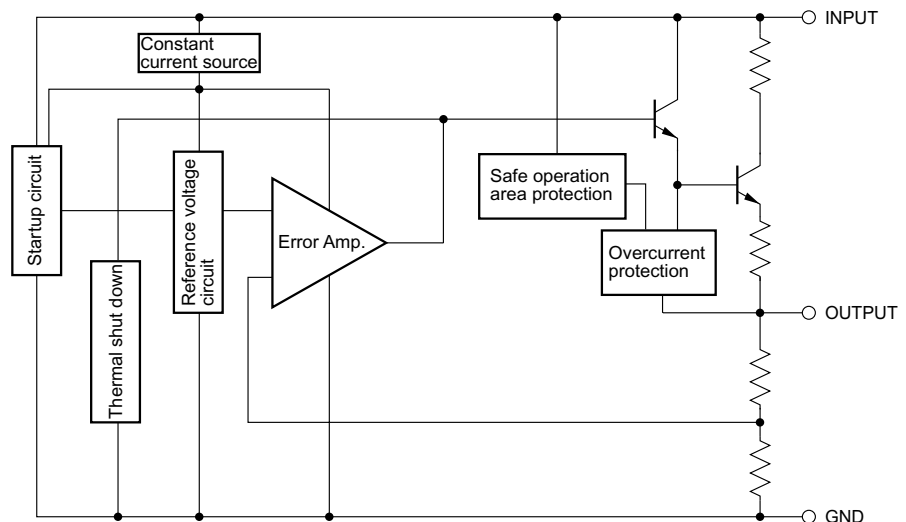

ORDERING INFORMATION

Part Number	Package	Outputs	Marking	Packing Type
μ PC3533HF	MP-45G (Isolated TO-220)	3.3 V	3533	• Bag stuffing
μ PC3540HF	MP-45G (Isolated TO-220)	4.0 V	3504	• Bag stuffing

The information in this document is subject to change without notice. Before using this document, please confirm that this is the latest version.
Not all devices/types available in every country. Please check with local NEC representative for availability and additional information.

ABSOLUTE MAXIMUM RATINGS ($T_A = 25^\circ\text{C}$ unless otherwise specified)

Parameter	Symbol	Rating	Unit
Input Voltage	V_{IN}	-0.3 to +25	V
Internal Power Dissipation ($T_C = 25^\circ\text{C}$)	P_T	15 ^{Note}	W
Operating Ambient Temperature	T_A	-40 to +85	$^\circ\text{C}$
Operating Junction Temperature	T_J	-40 to +150	$^\circ\text{C}$
Storage Temperature	T_{stg}	-55 to +150	$^\circ\text{C}$
Thermal Resistance (junction to case)	$R_{th(J-C)}$	7	$^\circ\text{C/W}$
Thermal Resistance (junction to ambient)	$R_{th(J-A)}$	65	$^\circ\text{C/W}$

Note Internally limited. When the operating junction temperature rises over 150°C , the internal circuit shuts down the output voltage.

Caution Product quality may suffer if the absolute maximum rating is exceeded even momentarily for any parameter. That is, the absolute maximum ratings are rated values at which the product is on the verge of suffering physical damage, and therefore the product must be used under conditions that ensure that the absolute maximum ratings are not exceeded.

TYPICAL CONNECTION

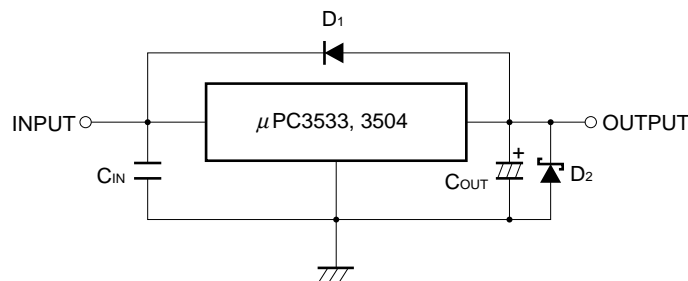

C_{IN} : 0.1 to 0.47 μF or higher. Set this value according to the length of the line between the regulator and INPUT pin. Be sure to connect C_{IN} to prevent parasitic oscillation. Use of a film capacitor or other capacitor with excellent voltage and temperature characteristics is recommended. If using a laminated ceramic capacitor, it is necessary to ensure that C_{IN} is 0.1 μF or higher for the voltage and temperature range to be used.

C_{OUT} : 0.1 μF or higher. Be sure to connect C_{OUT} to prevent oscillation and improve excessive load regulation. Place C_{IN} and C_{OUT} as close as possible to the IC pins (within 2 cm). Also, use an electrolytic capacitor with low impedance characteristics if considering use at sub-zero temperatures.

D1: If the OUTPUT pin has a higher voltage than the INPUT pin, connect a diode.

D2: If the OUTPUT pin has a lower voltage than the GND pin, connect a Schottky barrier diode.

Caution Make sure that no voltage is applied to the OUTPUT pin from external.

RECOMMENDED OPERATING CONDITIONS

Parameter	Symbol	Type Number	MIN.	TYP.	MAX.	Unit
Input Voltage	V _{IN}	μPC3533	5.8		20	V
		μPC3504	6.5		20	V
Output Current	I _o	All	0.005		1	A

Caution Use of conditions other than the above-listed recommended operating conditions is not a problem as long as the absolute maximum ratings are not exceeded. However, since the use of such conditions diminishes the margin of safety, careful evaluation is required before such conditions are used. Moreover, using the MAX. value for all the recommended operating conditions is not guaranteed to be safe.

ELECTRICAL CHARACTERISTICS

μPC3533 (T_J = 25°C, V_{IN} = 5.8 V, I_o = 0.5 A, C_{IN} = 0.33 μF, C_{OUT} = 0.1 μF, unless otherwise specified)

Parameter	Symbol	Conditions	MIN.	TYP.	MAX.	Unit
Output Voltage	V _{O1}		3.168	3.3	3.432	V
	V _{O2}	5.8 V ≤ V _{IN} ≤ 20 V, 5 mA ≤ I _o ≤ 1 A	3.135		3.465	V
Line Regulation	REG _{IN1}	5.8 V ≤ V _{IN} ≤ 20 V		20	50	mV
	REG _{IN2}	5.8 V ≤ V _{IN} ≤ 9 V		10	30	mV
Load Regulation	REG _{L1}	5 mA ≤ I _o ≤ 1 A		20	50	mV
	REG _{L2}	250 mA ≤ I _o ≤ 750 mA		10	20	mV
Quiescent Current	I _{BIAS}			2.8	6	mA
Quiescent Current Change	ΔI _{BIAS1}	5.8 V ≤ V _{IN} ≤ 20 V			1.0	mA
Output Noise Voltage	V _n	10 Hz ≤ f ≤ 100 kHz		55		μV _{r.m.s.}
Ripple Rejection	R•R	f = 120 Hz, 5.8 V ≤ V _{IN} ≤ 9 V		57		dB
Dropout Voltage	V _{DIF}	I _o = 1 A		2.0	2.5	V
Short Circuit Current	I _{Oshort1}	V _{IN} = 5.8 V		1.8		A
Peak Output Current	I _{Opeak}	V _{IN} = 10 V	1.0	2.1	2.8	A
Temperature Coefficient of Output Voltage	ΔV _o / ΔT	I _o = 5 mA, 0°C ≤ T _J ≤ 125°C		-0.4		mV/°C

μPC3504 (T_J = 25°C, V_{IN} = 6.5 V, I_o = 0.5 A, C_{IN} = 0.33 μF, C_{OUT} = 0.1 μF, unless otherwise specified)

Parameter	Symbol	Conditions	MIN.	TYP.	MAX.	Unit
Output Voltage	V _{O1}		3.84	4.0	4.16	V
	V _{O2}	6.5 V ≤ V _{IN} ≤ 20 V, 5 mA ≤ I _o ≤ 1 A	3.80		4.20	V
Line Regulation	REG _{IN1}	6.5 V ≤ V _{IN} ≤ 20 V		20	50	mV
	REG _{IN2}	6.5 V ≤ V _{IN} ≤ 10 V		10	30	mV
Load Regulation	REG _{L1}	5 mA ≤ I _o ≤ 1 A		20	50	mV
	REG _{L2}	250 mA ≤ I _o ≤ 750 mA		10	20	mV
Quiescent Current	I _{BIAS}			2.8	6	mA
Quiescent Current Change	ΔI _{BIAS1}	6.5 V ≤ V _{IN} ≤ 20 V			1.0	mA
Output Noise Voltage	V _n	10 Hz ≤ f ≤ 100 kHz		55		μV _{r.m.s.}
Ripple Rejection	R•R	f = 120 Hz, 6.5 V ≤ V _{IN} ≤ 10 V		60		dB
Dropout Voltage	V _{DIF}	I _o = 1 A		2.0	2.5	V
Short Circuit Current	I _{Oshort1}	V _{IN} = 6.5 V		1.8		A
Peak Output Current	I _{Opeak}	V _{IN} = 10 V	1.1	2.1	2.8	A
Temperature Coefficient of Output Voltage	ΔV _o / ΔT	I _o = 5 mA, 0°C ≤ T _J ≤ 125°C		-0.4		mV/°C

★ TYPICAL CHARACTERISTICS (Reference Values)

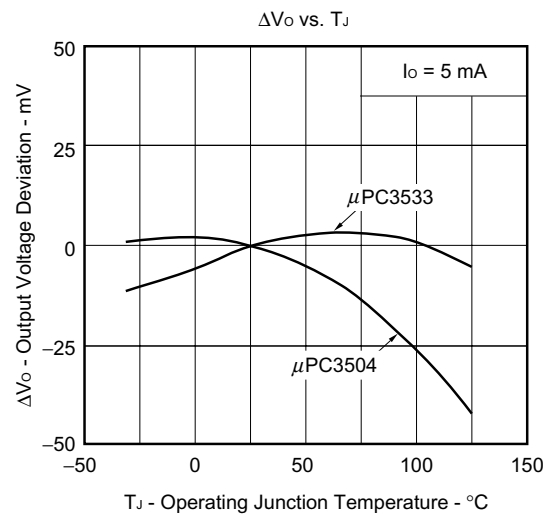
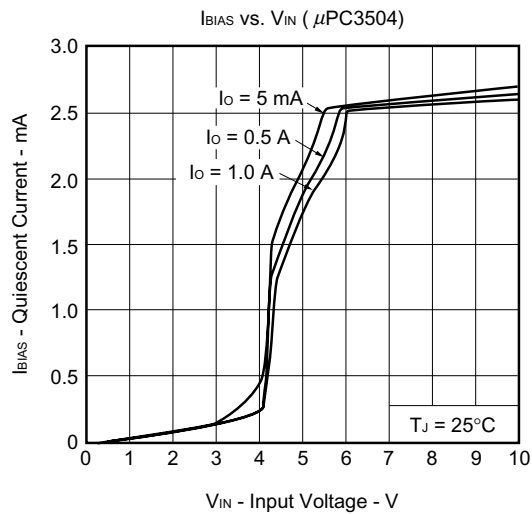
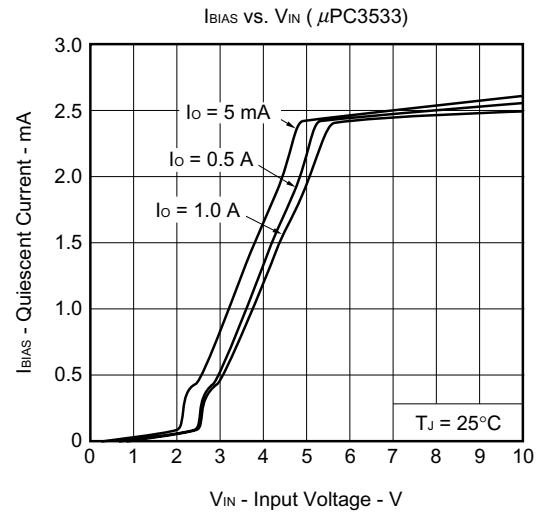
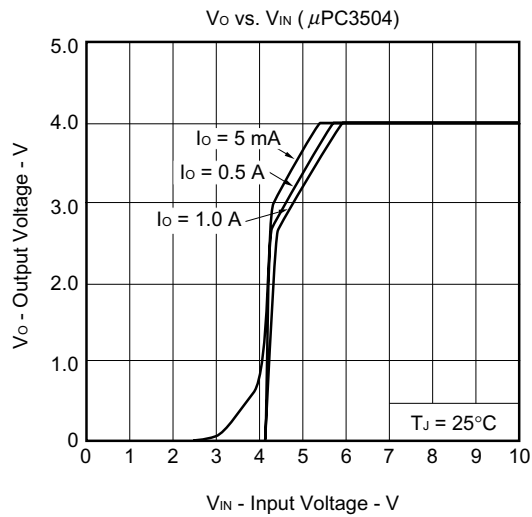
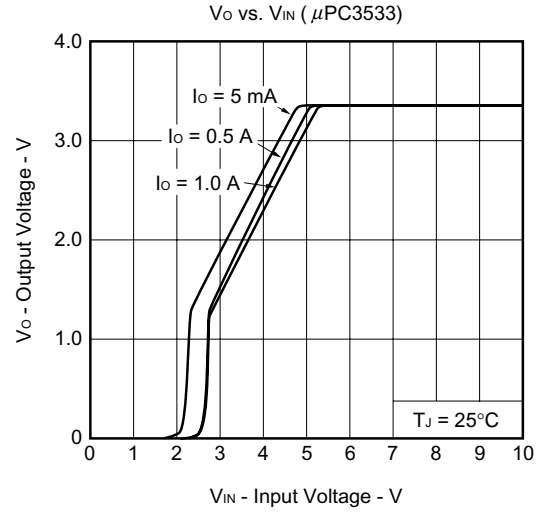
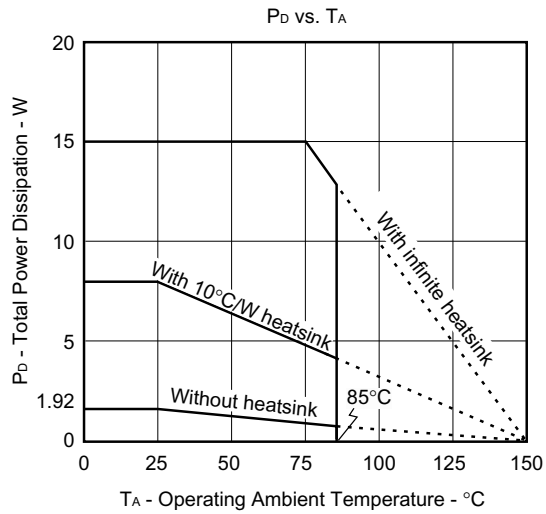

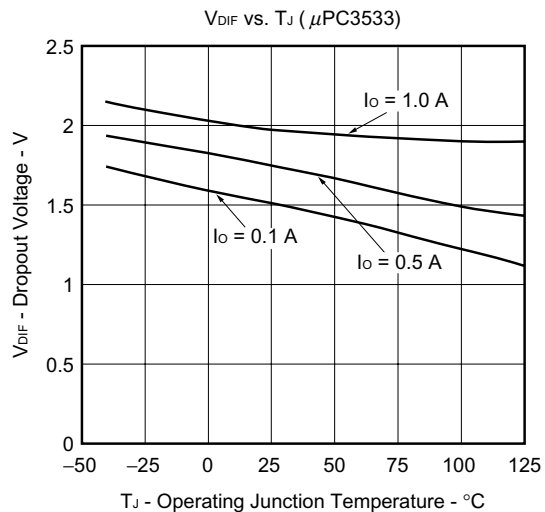
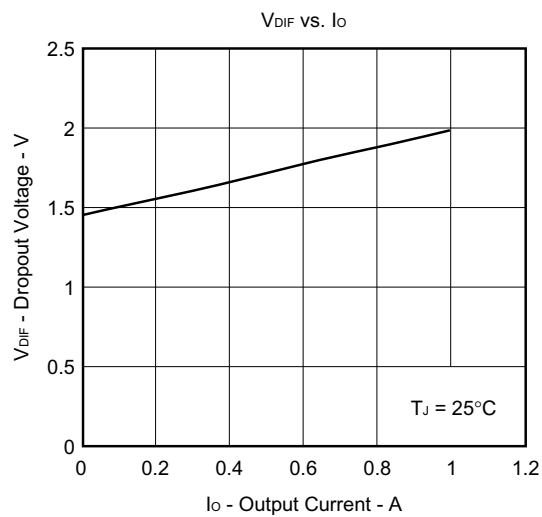
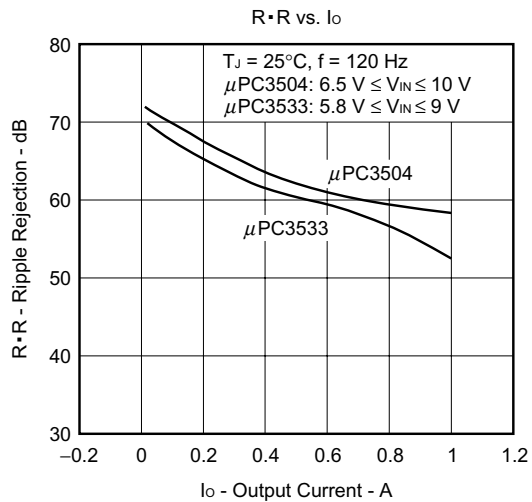
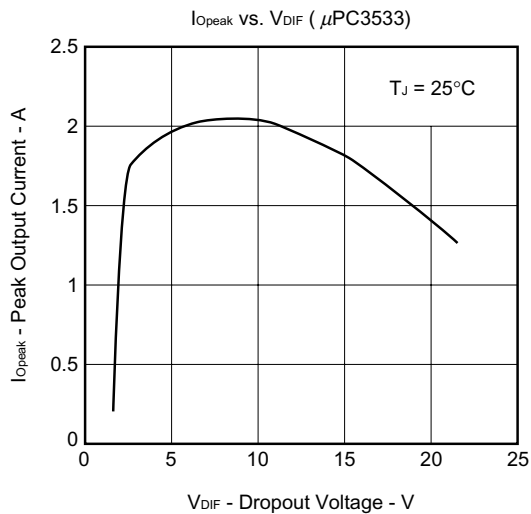
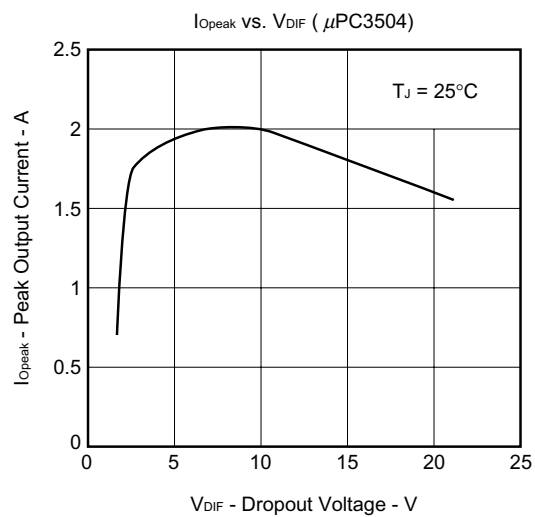
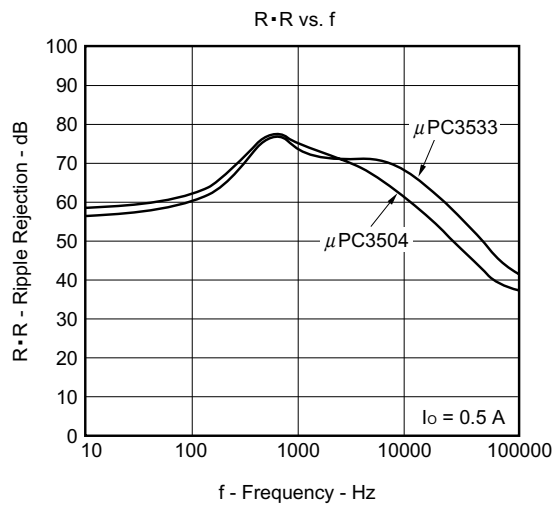

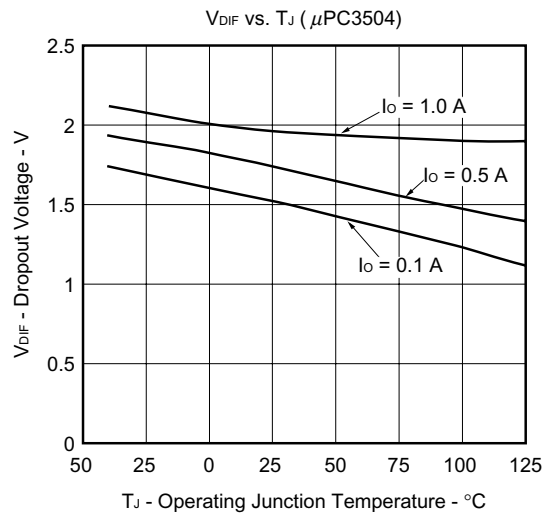

PACKAGE DRAWING

μPC3533HF, 3504HF
 3PIN PLASTIC SIP (MP-45G)

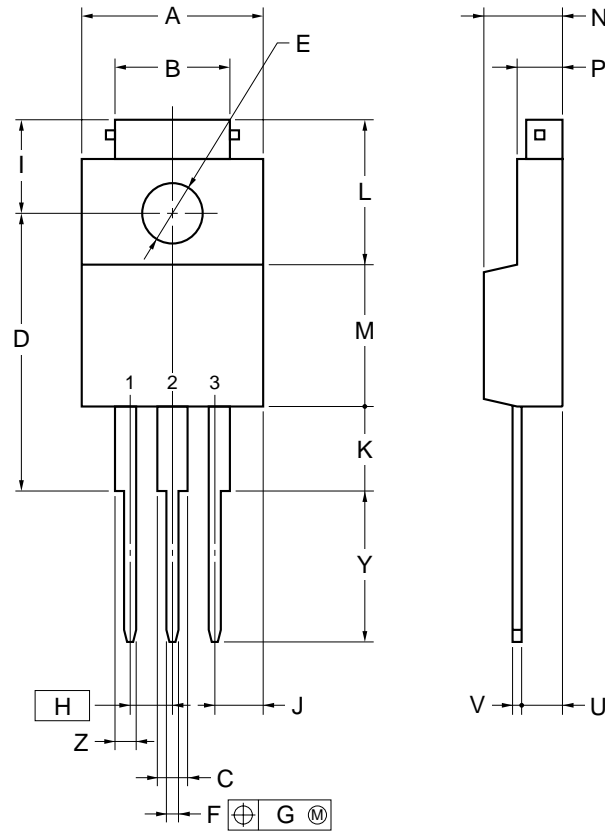

NOTE

Each lead centerline is located within 0.25 mm of its true position (T.P.) at maximum material condition.

ITEM	MILLIMETERS
A	10.0±0.2
B	7.0±0.2
C	1.50±0.2
D	17.0±0.3
E	φ3.3±0.2
F	0.75±0.10
G	0.25
H	2.54 (T.P.)
I	5.0±0.3
J	2.46±0.2
K	5.0±0.2
L	8.5±0.2
M	8.5±0.2
N	4.5±0.2
P	2.8±0.2
U	2.4±0.5
V	0.65±0.10
Y	8.9±0.7
Z	1.30±0.2

P3HF-254B-4

RECOMMENDED MOUNTING CONDITIONS

The following conditions must be met for mounting conditions of the μPC3533, 3504.

For more details, refer to the **Semiconductor Device Mounting Technology Manual (C10535E)**.

Please consult with our sales offices in case other mounting process is used, or in case the mounting is done under different conditions.

Type of Through-hole Device

μPC3533HF, 3504HF: MP-45G

Process	Conditions
Wave Soldering (only to leads)	Solder temperature: 260°C or below, Flow time: 10 seconds or less
Partial Heating Method	Pin temperature: 300°C or below, Heat time: 3 seconds or less (Per each pin).

Caution For through-hole device, the wave soldering process must be applied only to leads, and make sure that the package body does not get jet soldered.