

LH5764/J

CMOS 64K (8K × 8) OTPROM/EPROM

FEATURES

- 8,192 × 8 bit organization
- Access times:
LH5764J: 200/250 ns (MAX.)
LH5764: 200/250 ns (MAX.)
- Single +5 V power supply
- Low power consumption:
Operating: 165 mW (MAX.)
Standby: 550 μW (MAX.)
- High speed programming:
tpw = 0.1 ms (V_{PP} = 12.75 V) or
tpw = 1 ms (V_{PP} = 12.5 V)
Compatible to INTEL quick pulse programming™ algorithm
(1 second programming)
- Fully static operation
- Three-state outputs
- TTL compatible I/O
- Pin compatible with the i2764
- Packages:
EPROM
28-pin, 600-mil Cerdip
OTPROM
28-pin, 600-mil DIP
28-pin, 450-mil SOP
- JEDEC standard pinout (CERDIP/DIP)

DESCRIPTION

The LH5764J is a CMOS UV erasable and electrically programmable read-only-memory, organized as 8,192 × 8 bits. It provides low power consumption in standby mode.

The LH5764 is a one-time PROM packaged in plastic DIP.

PIN CONNECTIONS

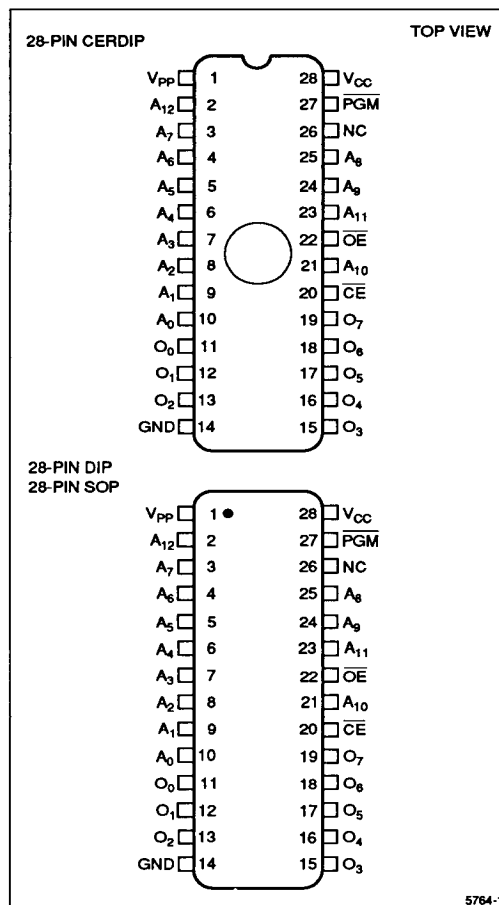

Figure 1. Pin Connections for CERDIP, DIP, and SOP Packages

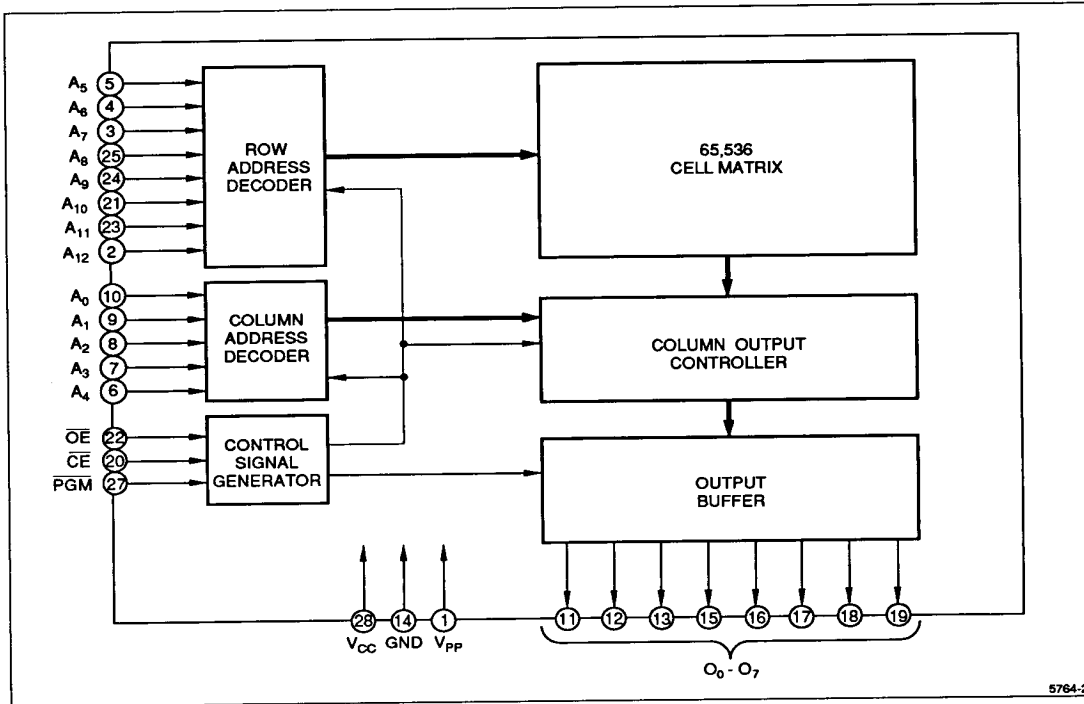

Figure 2. LH5764/J Block Diagram

PIN DESCRIPTION

SIGNAL	PIN NAME	NOTE
A ₀ - A ₁₂	Address input	
O ₀ - O ₇	Data output (input)	1
CE	Chip Enable input	
OE	Output Enable input	
PGM	Program input	

SIGNAL	PIN NAME	NOTE
V _{pp}	Program power	
V _{cc}	Power supply	
GND	Ground	
NC	Non connection	

NOTE:

1. O₀ - O₇ pins are also used to input data to the column output controller through input buffers in programming mode.

TRUTH TABLE

MODE		O ₀ - O ₇	CE	OE	PGM	V _{cc}	V _{pp}
Read	Read	Data out	L	L	H	+5 V	+5 V
	Output disable	High-Z	L	H	H	+5 V	+5 V
	Standby	High-Z	H	X	X	+5 V	+5 V
Program	Program	Data in	L	H	L	+6.25 V	+12.75 V
	Program verify	Data out	L	L	H	+6.25 V	+12.75 V
	Program inhibit	High-Z	H	X	X	+6.25 V	+12.75 V

NOTE:

X = H or L, H = V_H, L = V_L

ABSOLUTE MAXIMUM RATINGS

PARAMETER	SYMBOL	RATING	UNIT	NOTE
Supply voltage	V _{CC}	-0.6 to +7.0	V	1
	V _{PP}	-0.6 to +13.5		
	V _{IN}	-0.6 to +7.0		
Operating temperature	T _{opr}	0 to +70	°C	
Storage temperature	T _{stg}	-65 to +150	°C	2
		-55 to +150		3

NOTES:

- The maximum applicable voltage on any pin with respect to GND.
Maximum ratings are those values beyond which damage to the device may occur.
- Applied to ceramic package.
- Applied to plastic package.

RECOMMENDED OPERATING CONDITIONS (Read Mode) (T_A = 0 to +70°C)

PARAMETER	SYMBOL	MIN.	TYP.	MAX.	UNIT
Supply voltage	V _{CC}	4.5	5.0	5.5	V
	V _{PP}	4.5	5.0	5.5	V
Input "Low" voltage	V _{IL}	-0.1		0.8	V
Input "High" voltage	V _{IH}	2.0		V _{CC} + 0.3	V

DC CHARACTERISTICS (Read Mode) (V_{CC} = 5 V ± 10%, V_{PP} = V_{CC}, T_A = 0 to +70°C)

PARAMETER	SYMBOL	CONDITIONS	MIN.	TYP.	MAX.	UNIT	NOTE
Input "Low" voltage	V _{IL}		-0.1		0.8	V	
Input "High" voltage	V _{IH}		2.0		V _{CC} + 0.3	V	
Output "Low" voltage	V _{OL}	I _{OL} = 2.1 mA			0.45	V	
Output "High" voltage	V _{OH}	I _{OH} = -400 μA	2.4			V	
Input leakage current	I _{LI}	V _{IN} = GND or V _{CC}	-10		10	μA	
Output leakage current	I _{LO}	V _{OUT} = GND or V _{CC}	-10		10	μA	
V _{CC} operating current	I _{CC1}	$\overline{CE} = GND \pm 0.3 V$			25	mA	1, 2
	I _{CC2}	$\overline{CE} = V_{IL}$			30	mA	1, 3
V _{PP} supply current	I _{PP}	V _{PP} = V _{CC}			100	μA	
V _{PP} pin voltage	V _{PP}		V _{CC} - 0.4		V _{CC}	V	
V _{CC} standby current	I _{SB1}	$\overline{CE} = V_{CC} \pm 0.3 V$			100	μA	
	I _{SB2}	$\overline{CE} = V_{IH}$			1	mA	

NOTES:

- Minimum cycle time, I_{OUT} = 0 mA
- CMOS input: V_{IN} = GND ± 0.3 V or V_{CC} ± 0.3 V
- TTL input: V_{IN} = V_{IL} or V_{IH}

AC CHARACTERISTICS (Read Mode) ($V_{CC} = 5 V \pm 10\%$, $V_{PP} = V_{CC}$, $T_A = 0$ to $+70^\circ C$)

PARAMETER	SYMBOL	LH5764J-20		LH5764J-25 LH5764N-25		UNIT
		MIN.	MAX.	MIN.	MAX.	
Address to output delay	t_{ACC}		200		250	ns
\overline{CE} to output delay	t_{CE}		200		250	ns
\overline{OE} to output delay	t_{OE}		55		65	ns
Output enable high to output float	t_{DF}	0	55	0	65	ns
Address to output hold	t_{OH}	0		0		ns

AC TEST CONDITIONS

PARAMETER	MODE
Input voltage amplitude	0.8 V to 2.2 V
Input rise/fall time	≤ 10 ns
Input reference level	1 V, 2 V
Output reference level	0.8 V, 2 V

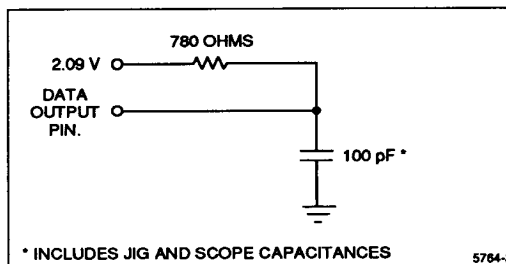

Figure 3. Output Load Circuit

CAPACITANCE ($T_A = 25^\circ C$, $f = 1$ MHz)

PARAMETER	SYMBOL	CONDITIONS	MIN.	TYP.	MAX.	UNIT
Input capacitance	C_{IN}	$V_{IN} = 0$ V		4	6	pF
Output capacitance	C_{OUT}	$V_{OUT} = 0$ V		8	12	pF

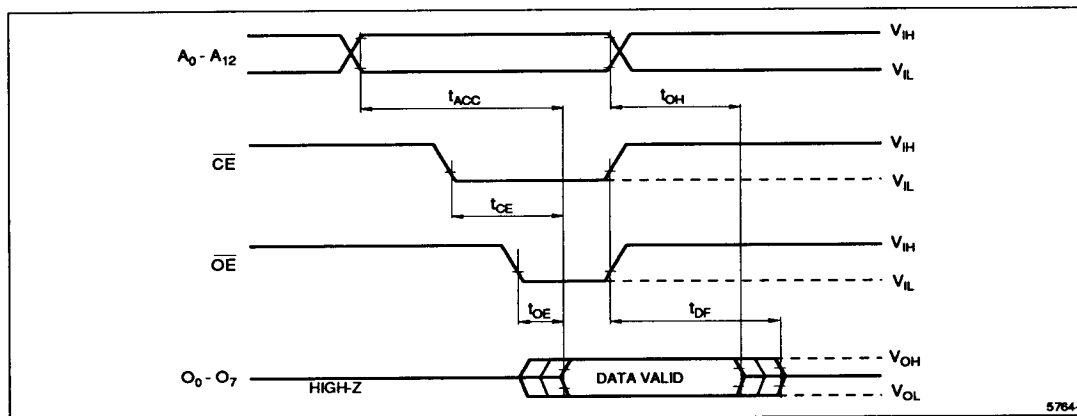

Figure 4. Timing Diagram (Read Mode)

RECOMMENDED OPERATING CONDITIONS (Program Mode) ($T_A = 25^\circ\text{C} \pm 5^\circ\text{C}$)

PARAMETER	SYMBOL	MIN.	TYP.	MAX.	UNIT
Supply voltage	V _{CC}	5.75	6.25	6.5	V
	V _{PP}	12.2	12.75	13.0	
Input "Low" voltage	V _{IL}	-0.1		0.45	V
Input "High" voltage	V _{IH}	2.4		V _{CC} + 0.3	

DC CHARACTERISTICS (Program Mode)(V_{CC} = 5.75 V to 6.5 V, V_{PP} = 12.2 V to 13.0 V, T_A = 25°C ± 5°C)

PARAMETER	SYMBOL	CONDITIONS	MIN.	TYP.	MAX.	UNIT
Input leakage current	I _{LI}	V _{IN} = V _{CC} or 0.45 V	-10		10	μA
V _{CC} supply current	I _{CC}				30	mA
V _{PP} supply current	I _{PP}	$\overline{\text{CE}} = \text{PGM} = \text{V}_{\text{IL}}$			30	mA
Input "Low" voltage	V _{IL}		-0.1		0.45	V
Input "High" voltage	V _{IH}		2.4		V _{CC} + 0.3	V
Output "Low" voltage	V _{OL}	I _{OL} = 2.1 mA			0.45	V
Output "High" voltage	V _{OH}	I _{OH} = -400 μA	2.4			V

AC CHARACTERISTICS (Program Mode)(V_{CC} = 6.25 V ± 0.25 V, V_{PP} = 12.75 V ± 0.25 V, T_A = 25°C ± 5°C) (Note 1)

PARAMETER	SYMBOL	MIN.	TYP.	MAX.	UNIT
Address setup time	t _{AS}	2			μs
Chip enable setup time	t _{CES}	2			μs
Output enable setup time	t _{OES}	2			μs
Data setup time	t _{DS}	2			μs
Address hold time	t _{AH}	0			μs
Data hold time	t _{DH}	2			μs
Chip enable to output float delay	t _{DF}	0		150	ns
Data valid from output enable	t _{OE}			150	ns
V _{PP} setup time	t _{VPS}	2			μs
V _{CC} setup time	t _{VCS}	2			μs
Program pulse width ^{1,2}	t _{PW}	95	100	105	μs
Program pulse count	N	1		25	TIMES

NOTES:

1. This width is defined by the Program Flowchart (Figure 6).
2. Programmable under conditions V_{CC} = 6.0 V ± 0.25 V, V_{PP} = 12.5 V ± 0.3 V, t_{PW} = 1 ms ± 0.05 ms

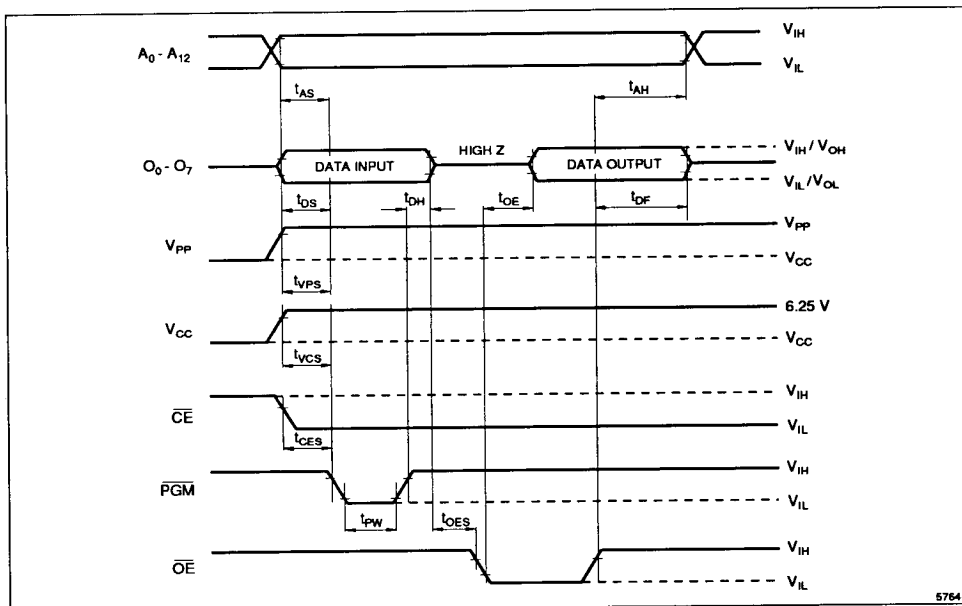

Figure 5. Timing Diagram (Program Mode)

PROGRAMMING

Upon delivery from SHARP or after each erasure (see erasure section), the LH5764 and LH5764J have all $8,192 \times 8$ bits in the "1", or high state. "0's" are loaded into the LH5764 and LH5764J through the procedure of programming.

The programming mode is entered when +12.75 V is applied to the V_{PP} pin and \overline{CE} is at V_{IL} . A $0.1 \mu\text{F}$ capacitor between V_{PP} and GND is needed to prevent excessive voltage transients, which could damage the device. The address to be programmed is applied to the proper address pins. 8-bit patterns are placed on the respective data pins. The voltage levels should be standard TTL levels.

ERASURE

In order to clear all locations of their programmed contents, it is necessary to expose the LH5764J to an ultra-violet light source. A dosage of 15W-second/cm^2 is required to completely erase an LH5764J. This dosage can be obtained by exposure to an ultra-violet lamp (wave-length of $2,537 \text{ \AA}$) with intensity of $12,000 \mu\text{W/cm}^2$ for 20 to 30 minutes. The LH5764J should be about one inch from the source and all filters should be removed from the UV light source prior to erasure.

It is important to note that the LH5764J and similar devices will erase with light sources having wave-length shorter than $4,000 \text{ \AA}$.

Although erasure times will be much longer than with UV sources at $2,537 \text{ \AA}$, the exposure to fluorescent light and sunlight will eventually erase the LH5764J and exposure to them should be prevented to realize maximum system reliability. If used in such an environment, the package windows should be covered by an opaque label or substance.

CAUTION

Fluorescent light and sunlight contain UV rays which will erase the EPROM. To prevent deterioration of EPROM data due to UV rays, it is recommended that EPROMs should not be left under direct sunlight or fluorescent light, or the package window should be covered with an opaque material.

Care must be taken to avoid friction between package window and plastics or the like, as the resulting static-electric build-up may cause faulty operation.

1. V_{CC} must be applied either coincidentally or before V_{PP} and removed either coincidentally or after V_{PP} .
2. V_{PP} must not be greater than 13.5 volts including overshoot.
3. During $\overline{CE} = \overline{PGM} = V_{IL}$, V_{PP} must not be switched from V_{CC} to 12.75 volts or vice-versa.
4. Removing or inserting the device while 12.75 volts is supplied may harm the reliability of the device.

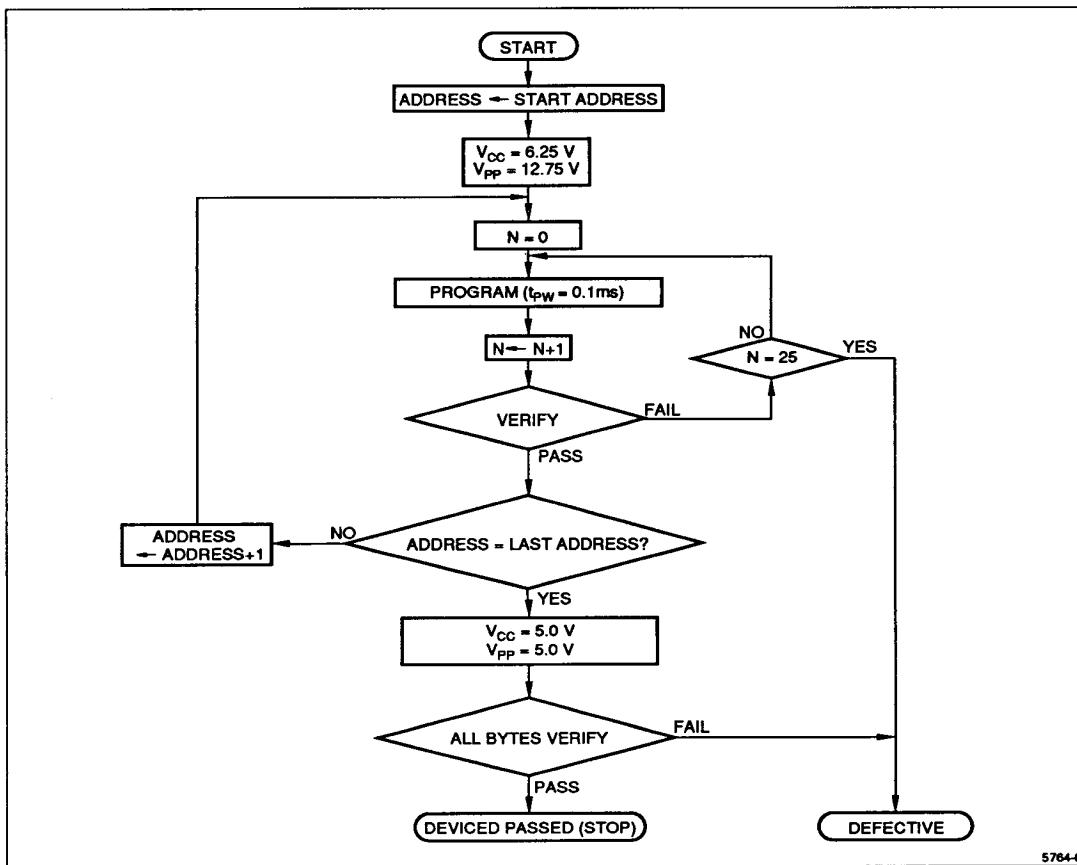

5764-6

Figure 6. Programming Flowchart

ORDERING INFORMATION

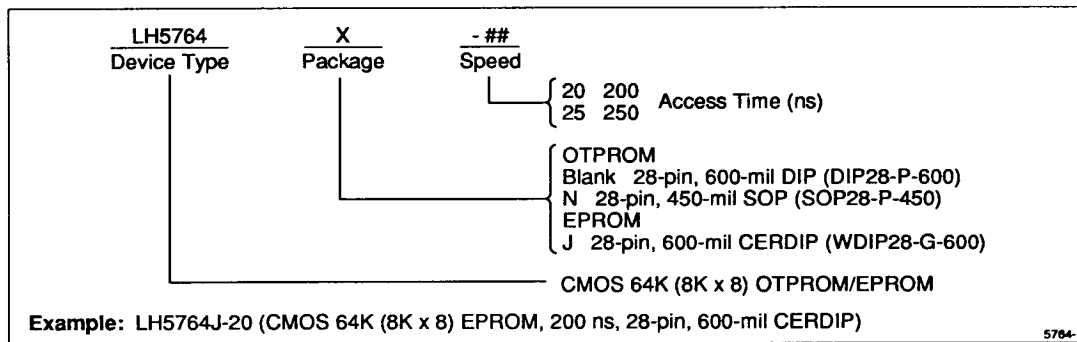

5764-7