

# Low Noise Pseudomorphic HEMT in a Surface Mount Plastic Package

## Technical Data

### ATF-33143

#### Features

- Low Noise Figure
- Excellent Uniformity in Product Specifications
- Low Cost Surface Mount Small Plastic Package SOT-343 (4 lead SC-70)
- Tape-and-Reel Packaging Option Available

#### Specifications

1.9 GHz; 4V, 80 mA (Typ.)

- 0.5 dB Noise Figure
- 15 dB Associated Gain
- 22 dBm Output Power at 1 dB Gain Compression
- 33.5 dBm Output 3<sup>rd</sup> Order Intercept

#### Applications

- Low Noise Amplifier and Driver Amplifier for Cellular/PCS Base Stations
- LNA for WLAN, WLL/RLL, LEO, and MMDS Applications
- General Purpose Discrete PHEMT for Other Ultra Low Noise Applications

#### Surface Mount Package SOT-343

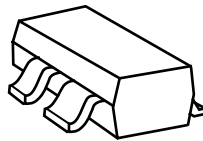

#### Pin Connections and Package Marking

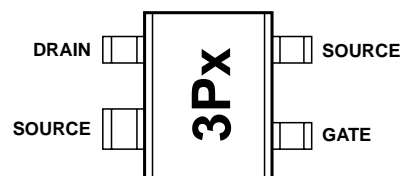

**Note:** Top View. Package marking provides orientation and identification.

“3P” = Device code

“x” = Date code character. A new character is assigned for each month, year.

#### Description

Agilent’s ATF-33143 is a high dynamic range, low noise, PHEMT housed in a 4-lead SC-70 (SOT-343) surface mount plastic package.

Based on its featured performance, ATF-33143 is suitable for applications in cellular and PCS base stations, LEO systems, MMDS, and other systems requiring super low noise figure with good intercept in the 450 MHz to 10 GHz frequency range.

## ATF-33143 Absolute Maximum Ratings<sup>[1]</sup>

Symbol	Parameter	Units	Absolute Maximum
$V_{DS}$	Drain - Source Voltage <sup>[2]</sup>	V	5.5
$V_{GS}$	Gate - Source Voltage <sup>[2]</sup>	V	-5
$V_{GD}$	Gate Drain Voltage <sup>[2]</sup>	V	-5
$I_{DS}$	Drain Current <sup>[2]</sup>	mA	$I_{dss}$ <sup>[3]</sup>
$P_{diss}$	Total Power Dissipation <sup>[4]</sup>	mW	600
$P_{in\ max}$	RF Input Power	dBm	20
$T_{CH}$	Channel Temperature <sup>[5]</sup>	°C	160
$T_{STG}$	Storage Temperature	°C	-65 to 160
$\theta_{jc}$	Thermal Resistance <sup>[6]</sup>	°C/W	145

### Notes:

1. Operation of this device above any one of these parameters may cause permanent damage.
2. Assumes DC quiescent conditions.
3.  $V_{GS} = 0V$
4. Source lead temperature is 25°C. Derate 6 mW/°C for  $T_L > 60^\circ C$ .
5. Please refer to failure rates in reliability section to assess the reliability impact of running devices above a channel temperature of 140°C.
6. Thermal resistance measured using 150°C Liquid Crystal Measurement method.

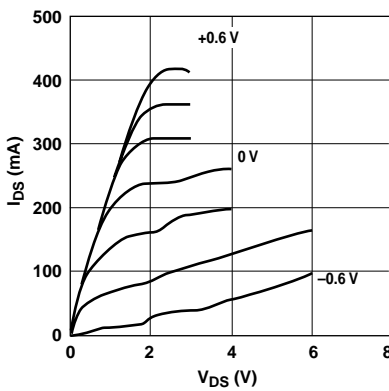

Figure 1. Typical Pulsed I-V Curves<sup>[7]</sup>.  
( $V_{GS} = -0.2V$  per step)

## Product Consistency Distribution Charts<sup>[8, 9]</sup>

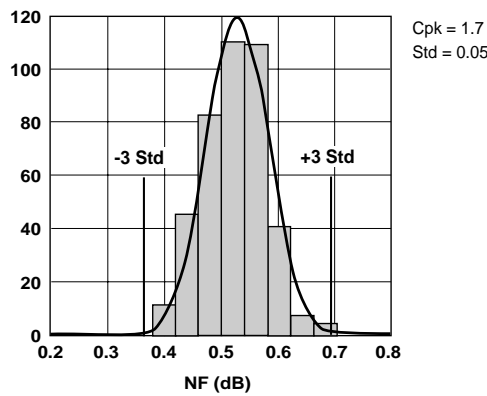

Figure 2. NF @ 2 GHz, 4 V, 80 mA.  
LSL=0.2, Nominal=0.53, USL=0.8

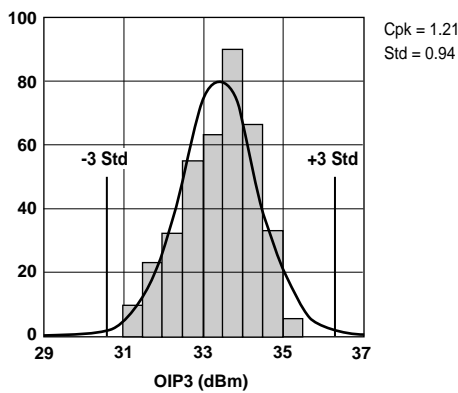

Figure 3. OIP3 @ 2 GHz, 4 V, 80 mA.  
LSL=30.0, Nominal=33.3, USL=37.0

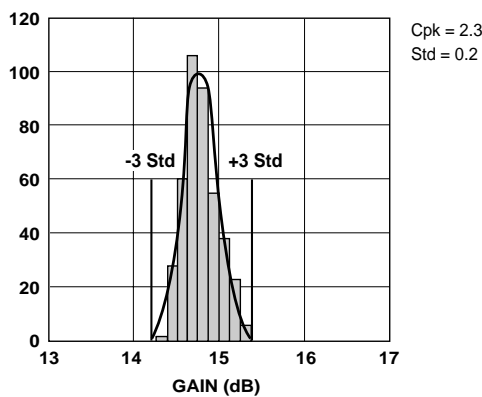

Figure 4. Gain @ 2 GHz, 4 V, 80 mA.  
LSL=13.5, Nominal=14.8, USL=16.5

### Notes:

7. Under large signal conditions,  $V_{GS}$  may swing positive and the drain current may exceed  $I_{dss}$ . These conditions are acceptable as long as the maximum  $P_{diss}$  and  $P_{in\ max}$  ratings are not exceeded.
8. Distribution data sample size is 450 samples taken from 9 different wafers.

9. Measurements made on production test board. This circuit represents a trade-off between an optimal noise match and a realizable match based on production

test requirements. Circuit losses have been de-embedded from actual measurements.

10. The probability of a parameter being between  $\pm 1\sigma$  is 68.3%, between  $\pm 2\sigma$  is 95.4% and between  $\pm 3\sigma$  is 99.7%.

## ATF-33143 DC Electrical Specifications

$T_A = 25^\circ\text{C}$ , RF parameters measured in a test circuit for a typical device

Symbol	Parameters and Test Conditions		Units	Min.	Typ. <sup>[2]</sup>	Max.
$I_{dss}^{[1]}$	Saturated Drain Current $V_{DS} = 1.5\text{ V}, V_{GS} = 0\text{ V}$		mA	175	237	305
$V_P^{[1]}$	Pinchoff Voltage $V_{DS} = 1.5\text{ V}, I_{DS} = 10\% \text{ of } I_{dss}$		V	-0.65	-0.5	-0.35
$I_d$	Quiescent Bias Current $V_{GS} = -0.5\text{ V}, V_{DS} = 4\text{ V}$		mA	—	80	—
$g_m^{[1]}$	Transconductance $V_{DS} = 1.5\text{ V}, g_m = I_{dss}/V_P$		mmho	360	440	—
$I_{GDO}$	Gate to Drain Leakage Current $V_{GD} = 5\text{ V}$		$\mu\text{A}$			1000
$I_{gss}$	Gate Leakage Current $V_{GD} = V_{GS} = -4\text{ V}$		$\mu\text{A}$	—	42	600
NF	Noise Figure	f = 2 GHz $V_{DS} = 4\text{ V}, I_{DS} = 80\text{ mA}$ $V_{DS} = 4\text{ V}, I_{DS} = 60\text{ mA}$	dB		0.5 0.5	0.8
		f = 900 MHz $V_{DS} = 4\text{ V}, I_{DS} = 80\text{ mA}$ $V_{DS} = 4\text{ V}, I_{DS} = 60\text{ mA}$	dB		0.4 0.4	
$G_a$	Associated Gain <sup>[3]</sup>	f = 2 GHz $V_{DS} = 4\text{ V}, I_{DS} = 80\text{ mA}$ $V_{DS} = 4\text{ V}, I_{DS} = 60\text{ mA}$	dB	13.5	15 15	16.5
		f = 900 MHz $V_{DS} = 4\text{ V}, I_{DS} = 80\text{ mA}$ $V_{DS} = 4\text{ V}, I_{DS} = 60\text{ mA}$	dB		21 21	
OIP3	Output 3 <sup>rd</sup> Order Intercept Point <sup>[3]</sup>	f = 2 GHz 5 dBm Pout/Tone $V_{DS} = 4\text{ V}, I_{DS} = 80\text{ mA}$ $V_{DS} = 4\text{ V}, I_{DS} = 60\text{ mA}$	dBm	30	33.5 32	
		f = 900 MHz 5 dBm Pout/Tone $V_{DS} = 4\text{ V}, I_{DS} = 80\text{ mA}$ $V_{DS} = 4\text{ V}, I_{DS} = 60\text{ mA}$	dBm		32.5 31	
$P_{1dB}$	1 dB Compressed Compressed Power <sup>[3]</sup>	f = 2 GHz $V_{DS} = 4\text{ V}, I_{DS} = 80\text{ mA}$ $V_{DS} = 4\text{ V}, I_{DS} = 60\text{ mA}$	dBm		22 21	
		f = 900 MHz $V_{DS} = 4\text{ V}, I_{DS} = 80\text{ mA}$ $V_{DS} = 4\text{ V}, I_{DS} = 60\text{ mA}$	dBm		21 20	

### Notes:

1. Guaranteed at wafer probe level.
2. Typical value determined from a sample size of 450 parts from 9 wafers.
3. Measurements obtained using production test board described in Figure 5.

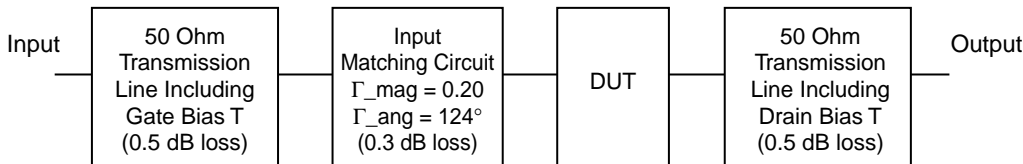

**Figure 5. Block diagram of 2 GHz production test board used for Noise Figure, Associated Gain,  $P_{1dB}$ , and OIP3 measurements. This circuit represents a trade-off between an optimal noise match and a realizable match based on production test requirements. Circuit losses have been de-embedded from actual measurements.**

## ATF-33143 Typical Performance Curves

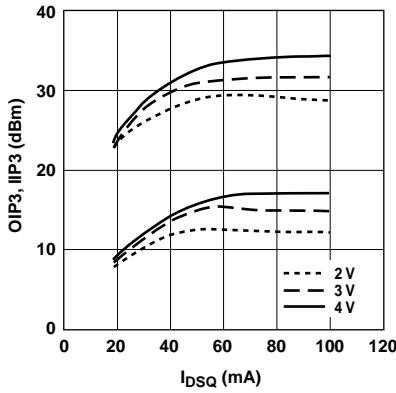

Figure 6. OIP3, IIP3 vs. Bias<sup>[1]</sup> at 2GHz.

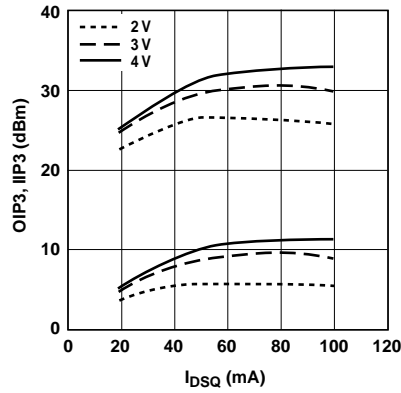

Figure 7. OIP3, IIP3 vs. Bias<sup>[1]</sup> at 900 MHz.

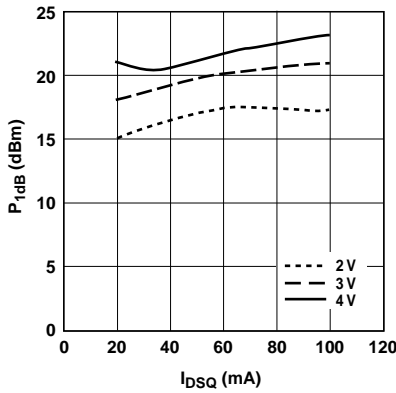

Figure 8. P<sub>1dB</sub> vs. Bias<sup>[1,2]</sup> at 2 GHz.

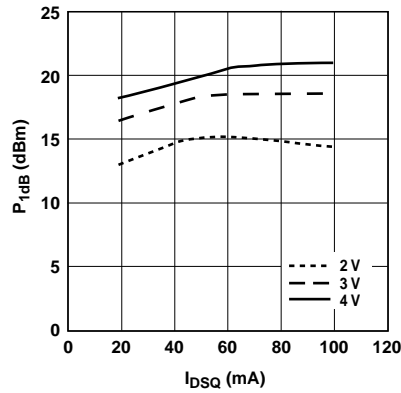

Figure 9. P<sub>1dB</sub> vs. Bias<sup>[1,2]</sup> Tuned for NF @ 4V, 80mA at 900MHz.

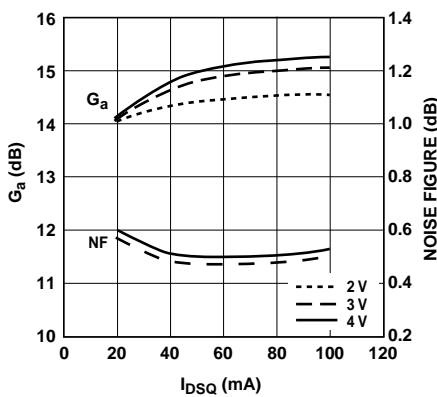

Figure 10. NF and G<sub>a</sub> vs. Bias<sup>[1]</sup> at 2GHz.

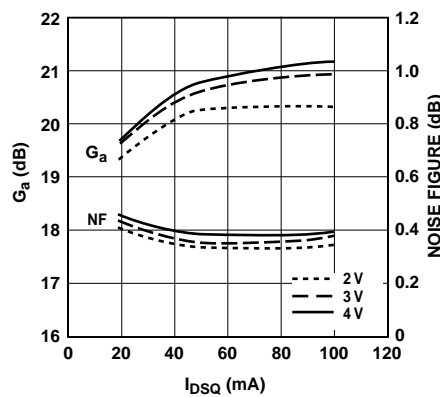

Figure 11. NF and G<sub>a</sub> vs. Bias<sup>[1]</sup> at 900 MHz.

### Notes:

1. Measurements made on a fixed tuned production test board that was tuned for optimal gain match with reasonable noise figure at 4V 80 mA bias. This circuit represents a trade-off between optimal noise match, maximum gain match and a realizable match based on production test board requirements. Circuit losses have been de-embedded from actual measurements.
2. Quiescent drain current, I<sub>DSQ</sub>, is set with zero RF drive applied. As P<sub>1dB</sub> is approached, the drain current may increase or decrease depending on frequency and dc bias point. At lower values of I<sub>DSQ</sub> the device is running closer to class B as power output approaches P<sub>1dB</sub>. This results in higher P<sub>1dB</sub> and higher PAE (power added efficiency) when compared to a device that is driven by a constant current source as is typically done with active biasing.

## ATF-33143 Typical Performance Curves, continued

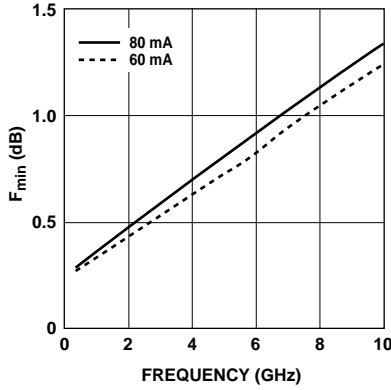

Figure 12.  $F_{min}$  vs. Frequency and Current at 4V.

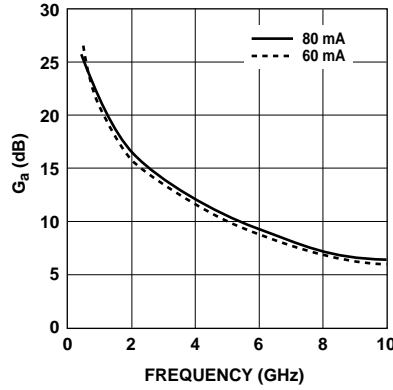

Figure 13. Associated Gain vs. Frequency and Current at 4V.

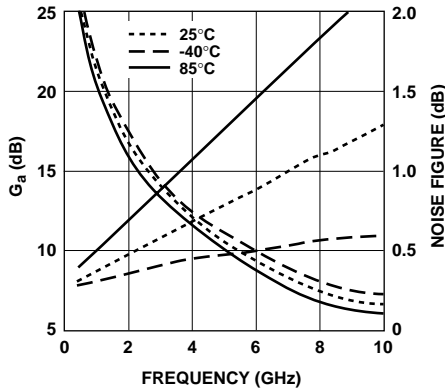

Figure 14.  $F_{min}$  and  $G_a$  vs. Frequency and Temp at  $V_{DS} = 4V$ ,  $I_{DS} = 80mA$ .

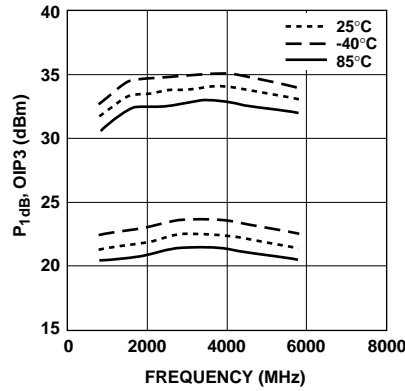

Figure 15.  $P_{1dB}$ , OIP3 vs. Frequency and Temp at  $V_{DS} = 4V$ ,  $I_{DS} = 80mA$ .

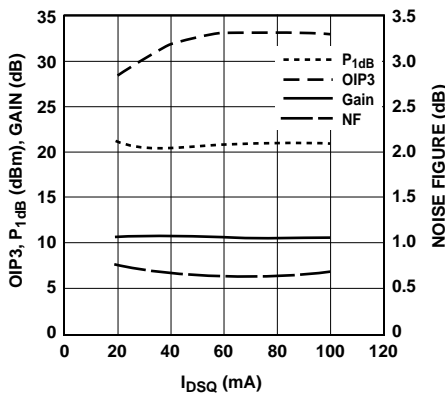

Figure 16. OIP3,  $P_{1dB}$ , NF and Gain vs. Bias<sup>[1,2]</sup> at 3.9 GHz.

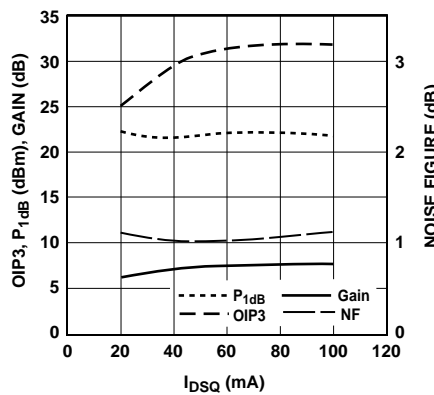

Figure 17. OIP3,  $P_{1dB}$ , NF and Gain vs. Bias<sup>[1,2]</sup> at 5.8 GHz.

### Notes:

- Measurements made on a fixed tuned test fixture that was tuned for noise figure at 4V 80 mA bias. This circuit represents a trade-off between optimal noise match, maximum gain match and a realizable match based on production test requirements. Circuit losses have been de-embedded from actual measurements.
- Quiescent drain current,  $I_{DSQ}$ , is set with zero RF drive applied. As  $P_{1dB}$  is approached, the drain current may increase or decrease depending on frequency and dc bias point. At lower values of  $I_{dsq}$  the device is running closer to class B as power output approaches  $P_{1dB}$ . This results in higher  $P_{1dB}$  and higher PAE (power added efficiency) when compared to a device that is driven by a constant current source as is typically done with active biasing.

## ATF-33143 Typical Performance Curves, continued

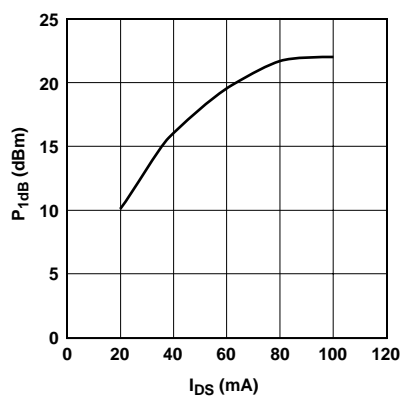

Figure 18. P<sub>1dB</sub> vs. I<sub>DS</sub> Active Bias<sup>[1]</sup>  
Tuned for NF @ 4 V, 80 mA at 2 GHz.

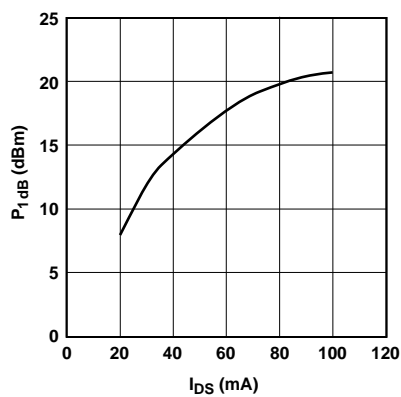

Figure 19. P<sub>1dB</sub> vs. I<sub>DS</sub> Active Bias<sup>[1]</sup>  
Tuned for NF @ 4 V, 80 mA at 900 MHz.

### Note:

1. Measurements made on a fixed tuned test board that was tuned for optimal gain match with reasonable noise figure at 4V 80 mA bias. This circuit represents a trade-off between an optimal noise match, maximum gain match and a realizable match based on production test board requirements. Circuit losses have been de-embedded from actual measurements.

**ATF-33143 Power Parameters Tuned for Max  $P_{1dB}$ ,  $V_{DS} = 4\text{ V}$ ,  $I_{DSQ} = 80\text{ mA}$**

Freq (GHz)	$P_{1dB}$ (dBm)	$I_d$ (mA)	$G_{1dB}$ (dB)	$PAE_{1dB}$ (%)	$P_{3dB}$ (dBm)	$I_d$ (mA)	$PAE_{3dB}$ (%)	$\Gamma_{\text{Out\_mag}}$ (Mag.)	$\Gamma_{\text{Out\_ang}}$ ( $^\circ$ )
0.9	20.7	89	23.2	33	23.2	102	51	0.39	160
1.5	21.2	91	20.7	36	23.8	116	51	0.43	165
1.8	21.1	80	19.2	40	23.0	94	52	0.43	170
2.0	21.6	81	18.1	44	23.2	89	57	0.42	174
4.0	23.0	97	11.9	48	24.6	135	48	0.40	-150
6.0	24.0	130	5.9	36	25.2	136	36	0.37	-124

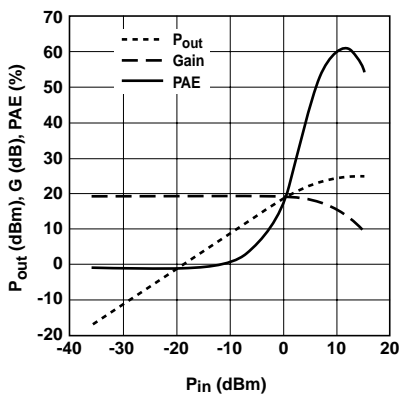

**Figure 20. Swept Power Tuned for Max  $P_{1dB}$**   
 $V_{DS} = 4\text{ V}$ ,  $I_{DSQ} = 80\text{ mA}$ ,  $2\text{ GHz}$ .

**Notes:**

1. Measurements made on ATN LP1 power load pull system.
2. Quiescent drain current,  $I_{DSQ}$ , is set with zero RF drive applied. As  $P_{1dB}$  is approached, the drain current may increase or decrease depending on frequency and dc bias point. At lower values of  $I_{DSQ}$  the device is running closer to class B as power output approaches  $P_{1dB}$ . This results in higher  $P_{1dB}$  and higher PAE (power added efficiency) when compared to a device that is driven by a constant current source as is typically done with active biasing.
3.  $PAE (\%) = ((P_{\text{out}} - P_{\text{in}}) / P_{\text{dc}}) \times 100$
4. Gamma out is the reflection coefficient of the matching circuit presented to the output of the device.

**ATF-33143 Typical Scattering Parameters,  $V_{DS} = 4\text{ V}$ ,  $I_{DS} = 60\text{ mA}$**

Freq. (GHz)	$S_{11}$		$S_{21}$			$S_{12}$			$S_{22}$		MSG/MAG (dB)
	Mag.	Ang.	dB	Mag.	Ang.	dB	Mag.	Ang.	Mag.	Ang.	
0.5	0.86	-75.60	23.20	14.45	132.90	-28.18	0.039	54.80	0.26	-118.50	25.69
0.8	0.77	-115.00	20.44	10.53	109.80	-25.35	0.054	42.20	0.34	-150.00	22.90
1.0	0.76	-122.50	19.80	9.77	105.30	-25.04	0.056	40.20	0.35	-155.50	22.42
1.5	0.73	-151.80	16.97	7.06	87.50	-23.61	0.066	33.20	0.39	-176.10	20.29
1.8	0.72	-164.60	15.54	5.99	79.20	-22.97	0.071	30.60	0.41	175.00	19.26
2.0	0.72	-171.80	14.67	5.41	74.20	-22.73	0.073	28.90	0.42	169.80	18.70
2.5	0.72	171.00	12.79	4.36	62.70	-21.94	0.080	25.10	0.45	160.60	17.36
3.0	0.73	158.20	11.18	3.62	53.00	-21.31	0.086	21.60	0.47	152.70	16.25
4.0	0.74	136.50	8.76	2.74	35.20	-20.00	0.100	13.70	0.49	139.90	10.91
5.0	0.75	117.00	6.99	2.24	17.50	-18.86	0.114	3.40	0.50	125.70	9.78
6.0	0.77	98.00	5.47	1.88	-1.00	-17.99	0.126	-8.90	0.51	109.10	9.03
7.0	0.79	80.20	3.94	1.57	-19.00	-17.52	0.133	-22.30	0.54	91.60	8.44
8.0	0.82	64.70	2.45	1.33	-34.90	-17.39	0.135	-33.60	0.57	75.90	7.78
9.0	0.83	50.60	1.27	1.16	-49.10	-17.08	0.140	-43.40	0.60	63.70	7.42
10.0	0.86	36.60	0.37	1.04	-64.30	-16.54	0.149	-55.20	0.63	52.00	7.68
11.0	0.88	21.80	-0.72	0.92	-80.40	-16.48	0.150	-68.40	0.66	38.50	7.61
12.0	0.90	7.50	-1.97	0.80	-96.20	-16.71	0.146	-81.10	0.70	22.50	7.44
13.0	0.91	-4.80	-3.45	0.67	-110.80	-17.27	0.137	-92.90	0.73	6.70	6.46
14.0	0.91	-15.40	-4.69	0.58	-122.80	-17.65	0.131	-101.60	0.76	-5.20	5.86
15.0	0.92	-27.30	-5.70	0.52	-135.40	-17.79	0.129	-111.60	0.79	-15.20	5.65
16.0	0.93	-40.40	-6.52	0.47	-148.30	-17.72	0.130	-122.20	0.81	-25.10	5.65
17.0	0.94	-52.20	-7.51	0.42	-162.10	-17.92	0.127	-134.70	0.82	-37.30	5.44
18.0	0.93	-61.20	-8.78	0.36	-172.80	-18.56	0.118	-143.30	0.84	-49.20	4.17

**ATF-33143 Typical Noise Parameters**

$V_{DS} = 4\text{ V}$ ,  $I_{DS} = 60\text{ mA}$

Freq. GHz	$F_{min}$ dB	$\Gamma_{opt}$		$R_{n/50}$ -	$G_a$ dB
		Mag.	Ang.		
0.5	0.29	0.42	31.40	0.080	25.91
0.9	0.33	0.33	44.70	0.070	21.80
1.0	0.34	0.32	48.00	0.070	21.00
1.5	0.38	0.26	71.90	0.060	18.14
1.8	0.39	0.22	94.00	0.050	16.96
2.0	0.42	0.22	109.70	0.046	16.29
2.5	0.47	0.25	149.40	0.030	14.95
3.0	0.51	0.29	166.80	0.030	13.58
4.0	0.63	0.39	-160.60	0.040	11.74
5.0	0.72	0.46	-135.30	0.060	10.36
6.0	0.82	0.51	-112.40	0.110	9.17
7.0	0.93	0.57	-90.90	0.210	8.18
8.0	1.03	0.61	-71.80	0.370	7.19
9.0	1.13	0.66	-55.50	0.550	6.56
10.0	1.22	0.69	-41.80	0.720	6.29

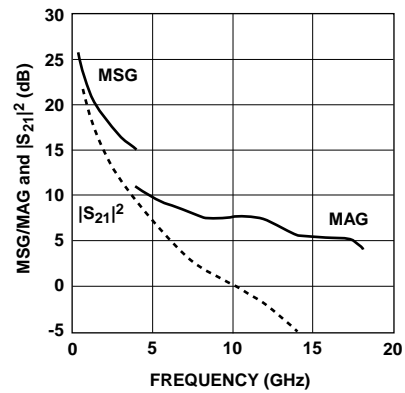

**Figure 22. MSG/MAG and  $|S_{21}|^2$  vs. Frequency at 4V, 60 mA.**

**Notes:**

1. The  $F_{min}$  values are based on a set of 16 noise figure measurements made at 16 different impedances using an ATF NP5 test system. From these measurements a true  $F_{min}$  is calculated. Refer to the noise parameter application section for more information.
2. S and noise parameters are measured on a microstrip line made on 0.025 inch thick alumina carrier. The input reference plane is at the end of the gate lead. The output reference plane is at the end of the drain lead. The parameters include the effect of four plated through via holes connecting source landing pads on top of the test carrier to the microstrip ground plane on the bottom side of the carrier. Two 0.020 inch diameter via holes are placed within 0.010 inch from each source lead contact point, one via on each side of that point.



**ATF-33143 Typical Scattering Parameters,  $V_{DS} = 4\text{ V}$ ,  $I_{DS} = 80\text{ mA}$**

Freq. (GHz)	$S_{11}$		$S_{21}$			$S_{12}$			$S_{22}$		MSG/MAG (dB)
	Mag.	Ang.	dB	Mag.	Ang.	dB	Mag.	Ang.	Mag.	Ang.	
0.5	0.86	-76.90	23.48	14.93	132.10	-28.64	0.037	55.40	0.26	-126.60	26.06
0.9	0.77	-115.90	20.64	10.77	109.10	-25.85	0.051	43.90	0.34	-155.50	23.25
1.0	0.76	-123.20	20.00	10.00	104.80	-25.51	0.053	42.10	0.35	-160.50	22.76
1.5	0.72	-151.70	17.13	7.18	87.40	-24.01	0.063	36.00	0.39	-180.00	20.57
2.0	0.72	-171.10	14.82	5.51	74.30	-22.97	0.071	32.10	0.43	166.60	18.90
2.5	0.72	170.10	12.96	4.45	62.60	-22.27	0.077	28.10	0.45	158.70	17.62
3.0	0.73	157.40	11.36	3.70	52.90	-21.51	0.084	24.60	0.47	151.20	16.44
4.0	0.74	135.90	8.92	2.79	35.40	-20.09	0.099	16.40	0.49	138.70	10.67
5.0	0.75	116.60	7.15	2.28	17.70	-18.86	0.114	5.70	0.50	124.70	9.78
6.0	0.77	97.60	5.63	1.91	-0.70	-17.99	0.126	-6.90	0.52	108.30	9.05
7.0	0.79	80.00	4.09	1.60	-18.60	-17.52	0.133	-20.60	0.54	91.00	8.50
8.0	0.82	64.50	2.61	1.35	-34.40	-17.33	0.136	-32.00	0.57	75.30	7.88
9.0	0.84	50.50	1.42	1.18	-48.60	-17.02	0.141	-42.10	0.61	63.10	7.53
10.0	0.86	36.40	0.52	1.06	-63.70	-16.48	0.150	-54.00	0.64	51.50	7.78
11.0	0.88	21.60	-0.57	0.94	-79.80	-16.42	0.151	-67.30	0.67	38.00	7.72
12.0	0.90	7.40	-1.81	0.81	-95.50	-16.59	0.148	-80.20	0.71	22.00	7.59
13.0	0.91	-4.90	-3.30	0.68	-110.00	-17.20	0.138	-92.00	0.74	6.40	6.55
14.0	0.91	-15.50	-4.54	0.59	-122.00	-17.59	0.132	-100.80	0.76	-5.60	5.97
15.0	0.92	-27.40	-5.51	0.53	-134.50	-17.65	0.131	-110.80	0.79	-15.50	5.76
16.0	0.93	-40.50	-6.34	0.48	-147.40	-17.65	0.131	-121.50	0.81	-25.40	5.78
17.0	0.94	-52.30	-7.33	0.43	-161.20	-17.86	0.128	-134.00	0.82	-37.60	5.57
18.0	0.93	-61.30	-8.61	0.37	-171.90	-18.49	0.119	-142.90	0.84	-49.50	4.30

**ATF-33143 Typical Noise Parameters**

$V_{DS} = 4\text{ V}$ ,  $I_{DS} = 80\text{ mA}$

Freq. GHz	$F_{min}$ dB	$\Gamma_{opt}$		$R_{n/50}$ -	$G_a$ dB
		Mag.	Ang.		
0.5	0.30	0.40	28.20	0.080	25.77
0.9	0.35	0.31	44.10	0.070	21.91
1.0	0.36	0.30	47.40	0.070	21.14
1.5	0.40	0.23	79.10	0.050	18.46
2.0	0.46	0.22	117.00	0.050	16.56
2.5	0.52	0.26	157.70	0.040	15.23
3.0	0.58	0.29	171.10	0.040	13.79
4.0	0.69	0.39	-157.20	0.044	11.92
5.0	0.80	0.46	-132.40	0.070	10.53
6.0	0.90	0.52	-109.40	0.130	9.37
7.0	1.02	0.57	-88.80	0.250	8.33
8.0	1.12	0.63	-70.50	0.420	7.41
9.0	1.21	0.66	-54.10	0.630	6.70
10.0	1.32	0.76	-40.40	0.830	6.69

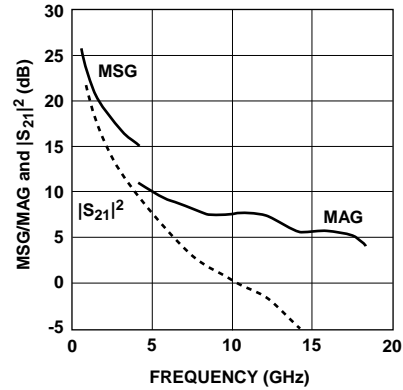

**Figure 23. MSG/MAG and  $|S_{21}|^2$  vs. Frequency at 4V, 80 mA.**

**Notes:**

1. The  $F_{min}$  values are based on a set of 16 noise figure measurements made at 16 different impedances using an ATF NP5 test system. From these measurements a true  $F_{min}$  is calculated. Refer to the noise parameter application section for more information.
2. S and noise parameters are measured on a microstrip line made on 0.025 inch thick alumina carrier. The input reference plane is at the end of the gate lead. The output reference plane is at the end of the drain lead. The parameters include the effect of four plated through via holes connecting source landing pads on top of the test carrier to the microstrip ground plane on the bottom side of the carrier. Two 0.020 inch diameter via holes are placed within 0.010 inch from each source lead contact point, one via on each side of that point.

## Noise Parameter

### Applications Information

$F_{min}$  values at 2 GHz and higher are based on measurements while the  $F_{mins}$  below 2 GHz have been extrapolated. The  $F_{min}$  values are based on a set of 16 noise figure measurements made at 16 different impedances using an ATN NP5 test system. From these measurements, a true  $F_{min}$  is calculated.  $F_{min}$  represents the true minimum noise figure of the device when the device is presented with an impedance matching network that transforms the source impedance, typically 50Ω, to an impedance represented by the reflection coefficient  $\Gamma_o$ . The designer must design a matching network that will present  $\Gamma_o$  to the device with minimal associated circuit losses. The noise figure of the completed amplifier is equal to the noise figure of the device plus the losses of the matching network preceding the device. The noise figure of the device is equal to  $F_{min}$  only when the device is

presented with  $\Gamma_o$ . If the reflection coefficient of the matching network is other than  $\Gamma_o$ , then the noise figure of the device will be greater than  $F_{min}$  based on the following equation.

$$NF = F_{min} + 4 \frac{R_n}{Z_o} \frac{|\Gamma_s - \Gamma_o|^2}{(1 + |\Gamma_o|^2)(1 - |\Gamma_s|^2)}$$

Where  $R_n/Z_o$  is the normalized noise resistance,  $\Gamma_o$  is the optimum reflection coefficient required to produce  $F_{min}$  and  $\Gamma_s$  is the reflection coefficient of the source impedance actually presented to the device. The losses of the matching networks are non-zero and they will also add to the noise figure of the device creating a higher amplifier noise figure. The losses of the matching networks are related to the Q of the components and associated printed circuit board loss.  $\Gamma_o$  is typically fairly low at higher frequencies and increases as frequency is lowered. Larger gate width devices will typically have a lower  $\Gamma_o$  as compared to narrower gate width devices.

Typically for FETs, the higher  $\Gamma_o$  usually infers that an impedance much higher than 50Ω is required for the device to produce  $F_{min}$ . At VHF frequencies and even lower L Band frequencies, the required impedance can be in the vicinity of several thousand ohms. Matching to such a high impedance requires very hi-Q components in order to minimize circuit losses. As an example at 900 MHz, when airwound coils ( $Q > 100$ ) are used for matching networks, the loss can still be up to 0.25 dB which will add directly to the noise figure of the device. Using multilayer molded inductors with Qs in the 30 to 50 range results in additional loss over the airwound coil. Losses as high as 0.5 dB or greater add to the typical 0.15 dB  $F_{min}$  of the device creating an amplifier noise figure of nearly 0.65 dB. A discussion concerning calculated and measured circuit losses and their effect on amplifier noise figure is covered in Agilent Application 1085.

## Reliability Data

Channel Temperature (°C)	Nominal Failures per million (FPM) for different durations					90% confidence Failures per million (FPM) for different durations				
	(FITs) 1000 hours	1 year	5 year	10 year	30 year	(FITs) 1000 hours	1 year	5 year	10 year	30 year
100	<0.1	<0.1	<0.1	<0.1	<0.1	<0.1	<0.1	<0.1	<0.1	<0.1
125	<0.1	<0.1	<0.1	<0.1	<0.1	<0.1	<0.1	<0.1	<0.1	11
140	<0.1	<0.1	<0.1	<0.1	160	<0.1	<0.1	6	160	9.3K
150	<0.1	<0.1	2	140	26K	<0.1	0.3	780	8800	131K
160	<0.1	<0.1	920	21K	370K	<0.1	67	24K	120K	520K
180	<0.1	4400	450K	830K	1000K	21	53K	590K	850K	1000K

NOT

recommended

Predicted failures with temperature extrapolated from failure distribution and activation energy data of higher temperature operational life STRIFE of PHEMT process

## ATF-33143 Die Model

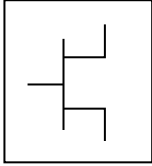

Statz Model

MESFETM1

NFET=yes

PFET=no

Vto=-0.95

Beta=0.48

Lambda=0.09

Alpha=4

B=0.8

Tnom=27

Idstc=

Vbi=0.7

Tau=

Betatce=

Delta1=0.2

Delta2=

Gscap=3

Cgs=1.6 pF

Gdcap=3

Cgd=0.32 pF

Rgd=

Tqm=

Vmax=

Fc=

Rd=.125

Rg=1

Rs=0.0625

Ld=0.00375 nH

Lg=0.00375 nH

Ls=0.00125 nH

Cds=0.08 pF

Crf=0.1

Rc=62.5

Gsfwd=1

Gsrev=0

Gdfwd=1

Gdrev=0

Vjr=1

Is=1 nA

Ir=1 nA

Imax=0.1

Xti=

N=

Eg=

Vbr=

Vtotc=

Rin=

Taumd1=no

Fnc=1E6

R=0.17

C=0.2

P=0.65

wVgfd=

wBvgS=

wBvgd=

wBvds=

wldsmax=

wPmax=

AllParams=

This model can be used as a design tool. It has been tested on MDS for various specifications. However, for more precise and accurate design, please refer to

the measured data in this data sheet. For future improvements Agilent reserves the right to change these models without prior notice.

## ATF-33143 Model

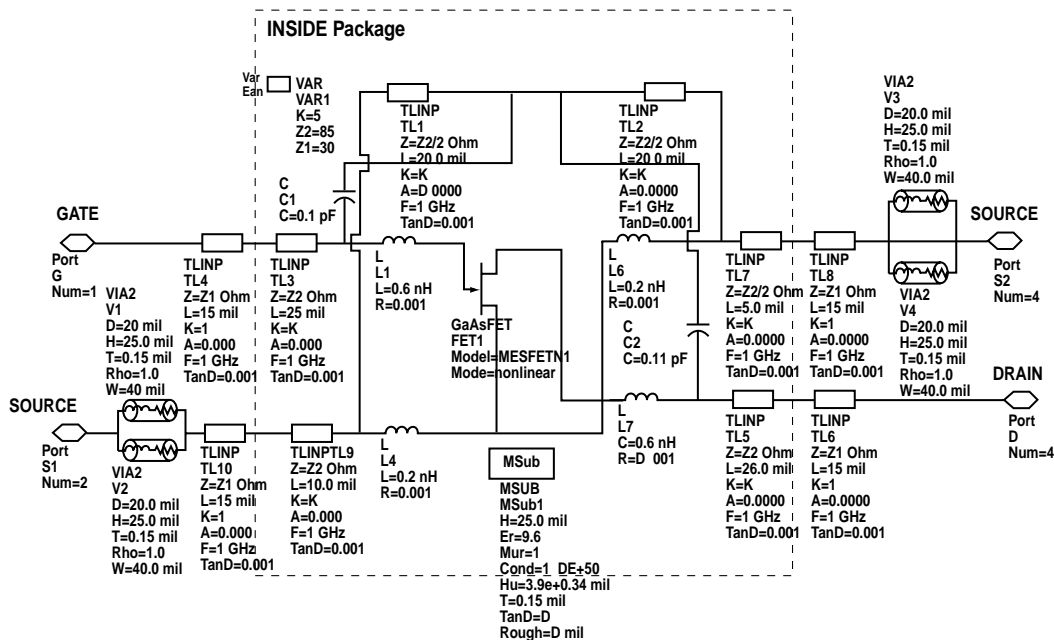

## Part Number Ordering Information

Part Number	No. of Devices	Container
ATF-33143-TR1	3000	7" Reel
ATF-33143-TR2	10000	13" Reel
ATF-33143-BLK	100	antistatic bag

## Package Dimensions

Outline 43 (SOT-343/SC-70 4 lead)

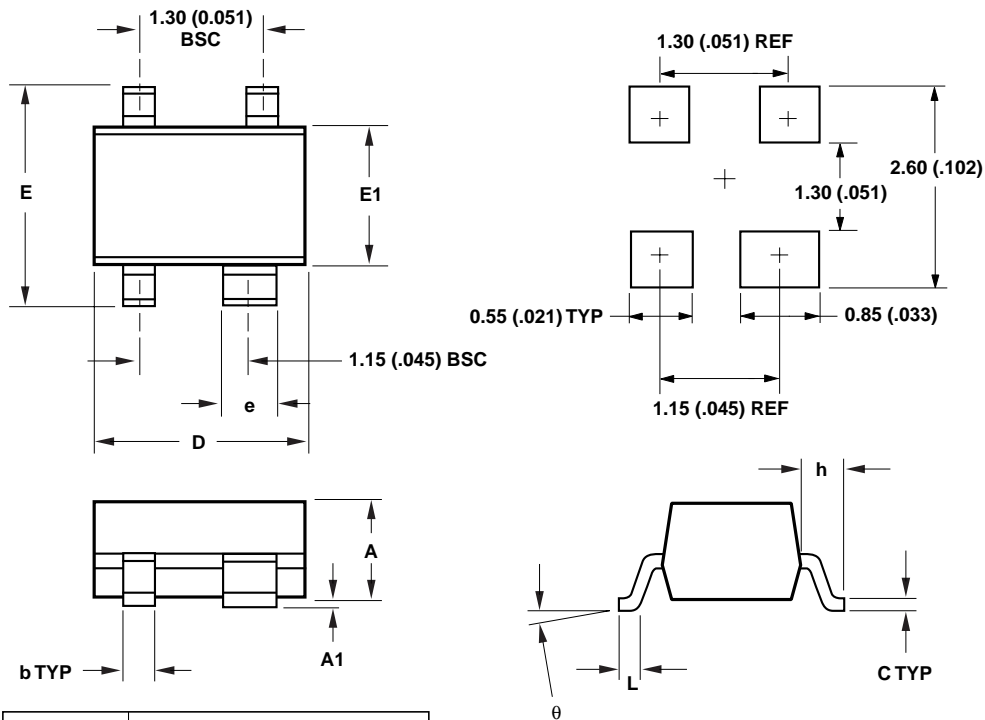

SYMBOL	DIMENSIONS	
	MIN.	MAX.
A	0.80 (0.031)	1.00 (0.039)
A1	0 (0)	0.10 (0.004)
b	0.25 (0.010)	0.35 (0.014)
C	0.10 (0.004)	0.20 (0.008)
D	1.90 (0.075)	2.10 (0.083)
E	2.00 (0.079)	2.20 (0.087)
e	0.55 (0.022)	0.65 (0.025)
h	0.450 TYP (0.018)	
E1	1.15 (0.045)	1.35 (0.053)
L	0.10 (0.004)	0.35 (0.014)
$\theta$	0	10

DIMENSIONS ARE IN MILLIMETERS (INCHES)

## Device Orientation

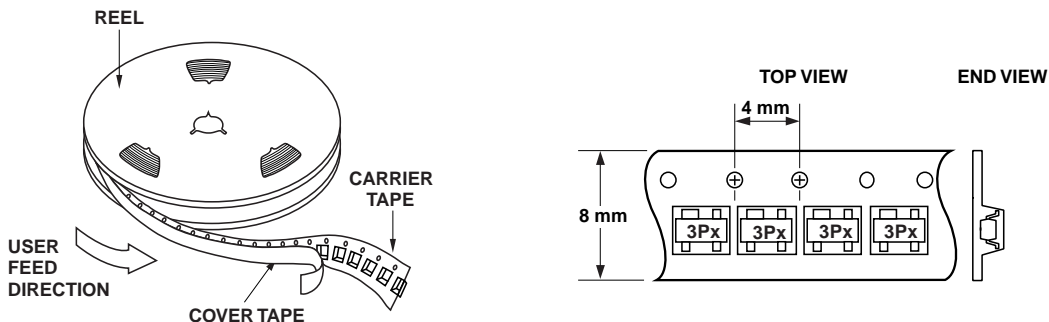

## Tape Dimensions For Outline 4T

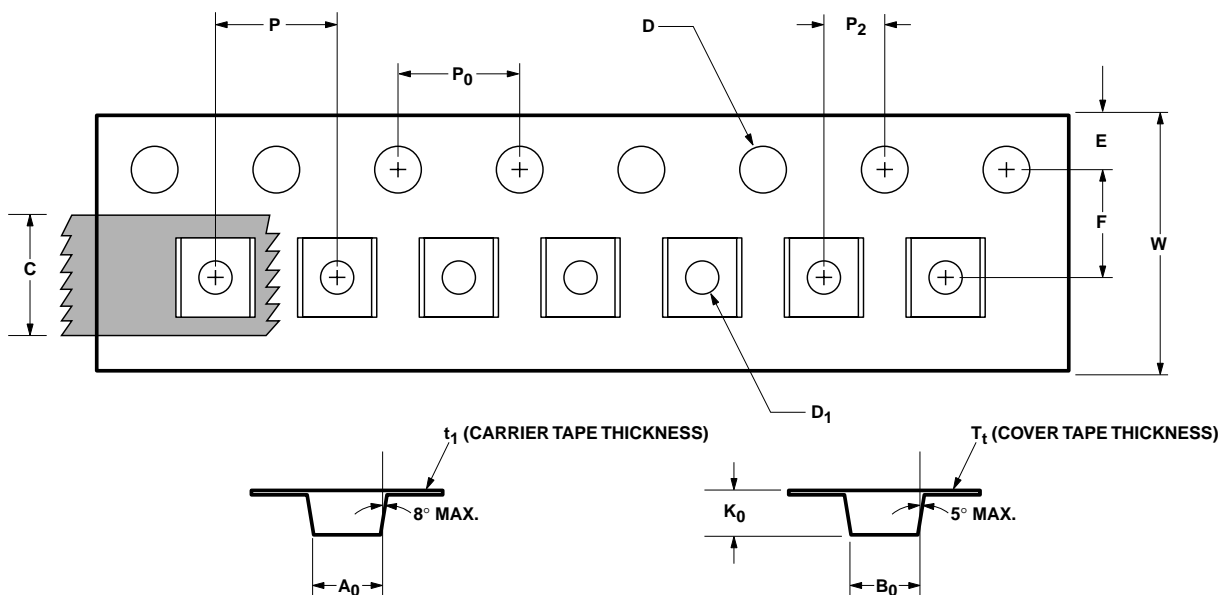

	DESCRIPTION	SYMBOL	SIZE (mm)	SIZE (INCHES)
CAVITY	LENGTH	$A_0$	$2.24 \pm 0.10$	$0.088 \pm 0.004$
	WIDTH	$B_0$	$2.34 \pm 0.10$	$0.092 \pm 0.004$
	DEPTH	$K_0$	$1.22 \pm 0.10$	$0.048 \pm 0.004$
	PITCH	$P$	$4.00 \pm 0.10$	$0.157 \pm 0.004$
	BOTTOM HOLE DIAMETER	$D_1$	$1.00 \pm 0.25$	$0.039 \pm 0.010$
PERFORATION	DIAMETER	$D$	$1.55 \pm 0.05$	$0.061 \pm 0.002$
	PITCH	$P_0$	$4.00 \pm 0.10$	$0.157 \pm 0.004$
	POSITION	$E$	$1.75 \pm 0.10$	$0.069 \pm 0.004$
CARRIER TAPE	WIDTH	$W$	$8.00 \pm 0.30$	$0.315 \pm 0.012$
	THICKNESS	$t_1$	$0.255 \pm 0.013$	$0.010 \pm 0.0005$
COVER TAPE	WIDTH	$C$	$5.4 \pm 0.10$	$0.205 \pm 0.004$
	TAPE THICKNESS	$T_t$	$0.062 \pm 0.001$	$0.0025 \pm 0.00004$
DISTANCE	CAVITY TO PERFORATION (WIDTH DIRECTION)	$F$	$3.50 \pm 0.05$	$0.138 \pm 0.002$
	CAVITY TO PERFORATION (LENGTH DIRECTION)	$P_2$	$2.00 \pm 0.05$	$0.079 \pm 0.002$

## 当社半導体部品のご使用にあたって

### 仕様及び仕様書に関して

- ・本仕様は製品改善および技術改良等により予告なく変更する場合があります。ご使用の際には最新の仕様を問い合わせの上、用途のご確認をお願いいたします。
- ・本仕様記載内容を無断で転載または複写することは禁じられております。
- ・本仕様内でご紹介している応用例(アプリケーション)は当社製品がご使用できる代表的なものです。ご使用において第三者の知的財産権などの保証または実施権の許諾に対して問題が発生した場合、当社はその責任を負いかねます。
- ・仕様書はメーカーとユーザ間で交わされる製品に関する使用条件や誤使用防止事項を言及するものです。仕様書の条件外で保存、使用された場合に動作不良、機械不良が発生しても当社は責任を負いかねます。ただし、当社は納品後1年以内に当社の責任に帰すべき理由で、不良或いは故障が発生した場合、無償で製品を交換いたします。
- ・仕様書の製品が製造上および政策上の理由で満足できない場合には変更の権利を当社が有し、その交渉は当社の要求によりすみやかに行われることとさせていただきます。なお、基本的に変更は3ヶ月前、廃止は1年前にご連絡致しますが、例外もございますので予めご了承ください。

### ご使用用途に関して

- ・当社の製品は、一般的な電子機器(コンピュータ、OA機器、通信機器、AV機器、家電製品、アミューズメント機器、計測機器、一般産業機器など)の一部に組み込まれて使用されるものです。極めて高い信頼性と安全性が要求される用途(輸送機器、航空・宇宙機器、海底中継器、原子力制御システム、生命維持のための医療機器などの財産・環境もしくは生命に悪影響を及ぼす可能性を持つ用途)を意図し、設計も製造もされているものではありません。それゆえ、本製品の安全性、品質および性能に関しては、仕様書(又は、カタログ)に記載してあること以外は明示的にも黙示的にも一切の保証をするものではありません。

### 回路設計上のお願い

- ・当社は品質、信頼性の向上に努力しておりますが、一般的に半導体製品の誤動作や、故障の発生は避けられません。本製品の使用に附随し、或いはこれに関連する誤動作、故障、寿命により、他人の生命又は財産に被害や悪影響を及ぼし、或いは本製品を取り付けまたは使用した設備、施設または機械器具に故障が生じ一般公衆に被害を起こしても、当社はその内容、程度を問わず、一切の責任を負いかねます。  
お客様の責任において、装置の安全設計をお願いいたします。