

**QUAD OPERATIONAL AMPLIFIERS**

The KA224 series consists of four independent, high gain, internally frequency compensated operational amplifiers which were designed specifically to operate from a single power supply over a wide voltage range.

Operation from split power supplies is also possible so long as the difference between the two supplies is 3 volts to 32 volts.

Application areas include transducer amplifier, DC gain blocks and all the conventional OP amp circuits which now can be easily implemented in single power supply systems.

**FEATURES**

- Internally frequency compensated for unity gain
- Large DC voltage gain: 100dB
- Wide power supply range: KA224/A, KA324/A: 3V-32V (or ± 1.5 ~ 15V)  
KA2902: 3V-26V (or ± 1.5V ~ 13V)
- Input common-mode voltage range includes ground
- Large output voltage swing: 0V DC to  $V_{CC}-1.5V$  DC
- Power drain suitable for battery operation.

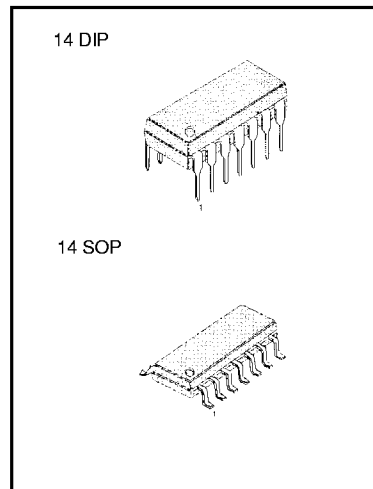

**BLOCK DIAGRAM**

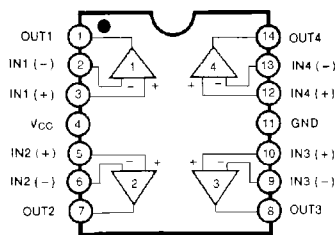

**ORDERING INFORMATION**

Device	Package	Operating Temperature
KA324 KA324A	14 DIP	0 ~ +70 °C
KA324D KA324AD	14 SOP	
KA224 KA224A	14 DIP	-25 ~ +85 °C
KA224D KA224AD	14 SOP	
KA2902 KA2902D	14 DIP 14 SOP	-40 ~ +85 °C

**SCHEMATIC DIAGRAM (One Section Only)**

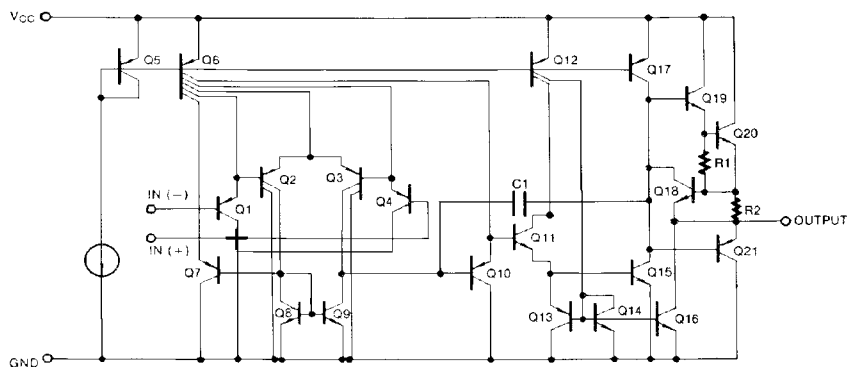

## ABSOLUTE MAXIMUM RATINGS

Characteristic	Symbol	KA224/KA224A	KA324/KA324A	KA2902	Unit
Power Supply Voltage	$V_{CC}$	$\pm 18$ or 32	$\pm 18$ or 32	$\pm 13$ or 26	V
Differential Input Voltage	$V_{I(DIFF)}$	32	32	26	V
Input Voltage	$V_I$	-0.3 to +32	-0.3 to +32	-0.3 to +26	V
Output Short Circuit to GND $V_{CC} \leq 15V$ $T_A = 25^\circ C$ (One Amp)		Continuous	Continuous	Continuous	
Power Dissipation	$P_D$	570	570	570	mW
Operating Temperature Range	$T_{OPR}$	-25 ~ +85	0 ~ +70	-40 ~ +85	$^\circ C$
Storage Temperature Range	$T_{STG}$	-65 ~ +150	-65 ~ +150	-65 ~ +150	$^\circ C$

## ELECTRICAL CHARACTERISTICS

(V<sub>CC</sub>=5.0V, V<sub>EE</sub>=GND, T<sub>A</sub>=25 $^\circ C$ , unless otherwise specified)

Characteristic	Symbol	Test Conditions	KA224			KA324			KA2902			Unit
			Min	Typ	Max	Min	Typ	Max	Min	Typ	Max	
Input Offset Voltage	$V_{IO}$	$V_{CM} = 0V$ to $V_{CC} = 1.5V$ $V_{O(P)} = 1.4V$ , $R_S = 0\Omega$		1.5	5.0		1.5	7.0		1.5	7.0	mV
Input Offset Current	$I_{IO}$			2.0	30		3.0	50		3.0	50	nA
Input Bias Current	$I_{BIAS}$			40	150		40	250		40	250	nA
Input Common-Mode Voltage Range	$V_{I(R)}$	$V_{CC} = 30V$ ( $V_{CC} = 26V$ for KA2902)	0		$V_{CC}$ -1.5	0	$V_{CC}$ -1.5		0		$V_{CC}$ -1.5	V
Supply Current	$I_{CC}$	$R_L = \quad$ , $V_{CC} = 30V$ (all Amps)		1.0	3		1.0	3		1.0	3	mA
		$R_L = \quad$ , $V_{CC} = 5V$ (all Amps) ( $V_{CC} = 26V$ for KA2902)		0.7	1.2		0.7	1.2		0.7	1.2	mA
Large Signal Voltage Gain	$G_V$	$V_{CC} = 15V$ , $R_L \geq 2K\Omega$ $V_{O(P)} = 1V$ to $11V$	50	100		25	100			100		V/mV
Output Voltage Swing	$V_{O(H)}$	$V_{CC} = 30V$ $R_L = 2K\Omega$	26			26			22			V
		$V_{CC} = 26V$ for 2902 $R_L = 10K\Omega$	27	28		27	28		23	24		V
	$V_{O(L)}$	$V_{CC} = 5V$ , $R_L \geq 10K\Omega$		5	20		5	20		5	100	mV
Common-Mode Rejection Ratio	CMRR		70	85		65	75		50	75		dB
Power Supply Rejection Ratio	PSRR		65	100		65	100		50	100		dB
Channel Separation	CS	$f = 1KHz$ to $20KHz$		120			120			120		dB
Short Circuit to GND	$I_{SC}$			40	60		40	60		40	60	mA
Output Current	$I_{SOURCE}$	$V_{I(+)} = 1V$ , $V_{I(-)} = 0V$ $V_{CC} = 15V$ , $V_{O(P)} = 2V$	20	40		20	40		20	40		mA
		$V_{I(+)} = 0V$ , $V_{I(-)} = 1V$ $V_{CC} = 15V$ , $V_{O(P)} = 2V$	10	13		10	13		10	13		mA
	$I_{SINK}$	$V_{I(+)} = 0V$ , $V_{I(-)} = 1V$ $V_{CC} = 15V$ , $V_{O(R)} = 200mV$	12	45		12	45					$\mu A$
Differential Input Voltage	$V_{I(DIFF)}$				$V_{CC}$			$V_{CC}$		$V_{CC}$		V

## ELECTRICAL CHARACTERISTICS

(V<sub>CC</sub> = 5.0V, V<sub>EE</sub> = GND, unless otherwise specified)The following specifications apply over the range of -25°C ≤ T<sub>A</sub> ≤ +85°C for the KA224; and the 0°C ≤ T<sub>A</sub> ≤ +70°C for the KA324; and the -40°C ≤ T<sub>A</sub> ≤ +85°C for the KA2902

Characteristic	Symbol	Test Conditions	KA224			KA324			KA2902			Unit
			Min	Typ	Max	Min	Typ	Max	Min	Typ	Max	
Input Offset Voltage	V <sub>IO</sub>	V <sub>ICM</sub> = 0V to V <sub>CC</sub> = 1.5V V <sub>O(P)</sub> = 1.4V, R <sub>S</sub> = 0Ω			7.0			9.0			10.0	mV
Input Offset Voltage Drift	Δ V <sub>IO</sub> /Δ T			7.0			7.0			7.0		μ V/°C
Input Offset Current	I <sub>IO</sub>				100			150			200	nA
Input Offset Current Drift	Δ I <sub>IO</sub> /Δ T			10			10			10		pA/°C
Input Bias Current	I <sub>BIAS</sub>				300			500			500	nA
Input Common-Mode Voltage Range	V <sub>IC(R)</sub>	V <sub>CC</sub> = 30V (V <sub>CC</sub> = 26V for KA2902)	0		V <sub>CC</sub> -2.0	0		V <sub>CC</sub> -2.0	0		V <sub>CC</sub> -2.0	V
Large Signal Voltage Gain	G <sub>V</sub>	V <sub>CC</sub> = 15V, R <sub>L</sub> ≥ 2.0KΩ V <sub>O(P)</sub> = 1V to 11V	25			15			15			V/mV
Output Voltage Swing	V <sub>O(H)</sub>	V <sub>CC</sub> = 30V, R <sub>L</sub> = 2KΩ	26			26			22			V
	V <sub>O(L)</sub>	V <sub>CC</sub> = 26V for 2902, R <sub>L</sub> = 10KΩ	27	28	20	27	28	20	23	24	100	V
Output Current	I <sub>SOURCE</sub>	V <sub>I(+)</sub> = 1V, V <sub>I(-)</sub> = 0V V <sub>CC</sub> = 15V, V <sub>O(P)</sub> = 2V	10	20		10	20		10	20		mA
	I <sub>SINK</sub>	V <sub>I(+)</sub> = 0V, V <sub>I(-)</sub> = 1V V <sub>CC</sub> = 15V, V <sub>O(P)</sub> = 2V	10	13		5	8		5	8		mA
Differential Input Voltage	V <sub>I(DIFS)</sub>				V <sub>CC</sub>			V <sub>CC</sub>			V <sub>CC</sub>	V

**ELECTRICAL CHARACTERISTICS**(V<sub>CC</sub>=50V, V<sub>EE</sub>=GND, T<sub>A</sub>=25°C, unless otherwise specified)

Characteristic	Symbol	Test Conditions	KA224A			KA324A			Unit
			Min	Typ	Max	Min	Typ	Max	
Input Offset Voltage	V <sub>IO</sub>	V <sub>CM</sub> = 0V to V <sub>CC</sub> = 1.5V V <sub>O(P)</sub> = 1.4V, R <sub>S</sub> = 0		1.0	3.0		1.5	3.0	mV
Input Offset Current	I <sub>IO</sub>			2	15		3.0	30	nA
Input Bias Current	I <sub>BIAS</sub>			40	80		40	100	nA
Input Common-Mode Voltage Range	V <sub>I(R)</sub>	V <sub>CC</sub> = 30V	0		V <sub>CC</sub> - 1.5	0		V <sub>CC</sub> - 1.5	V
Supply Current (All Amps)	I <sub>CC</sub>	V <sub>CC</sub> = 30V		1.5	3		1.5	3	mA
		V <sub>CC</sub> = 5V		0.7	1.2		0.7	1.2	mA
Large Signal Voltage Gain	G <sub>V</sub>	V <sub>CC</sub> = 15V, R <sub>L</sub> ≥ 2KΩ V <sub>O(P)</sub> = 1V to 11V	50	100		25	100		V/mV
Output Voltage Swing	V <sub>O(H)</sub>	V <sub>CC</sub> = 30V, R <sub>L</sub> = 2KΩ	26			26			V
		V <sub>CC</sub> = 26V for 2902, R <sub>L</sub> = 10KΩ	27	28		27	28		V
	V <sub>O(L)</sub>	V <sub>CC</sub> = 5V, R <sub>L</sub> ≥ 10KΩ		5	20		5	20	mV
Common-Mode Rejection Ratio	CMRR		70	85		65	85		dB
Power Supply Rejection Ratio	PSRR		65	100		65	100		dB
Channel Separation	CS	f = 1KHz to 20KHz		120			120		dB
Short Circuit to GND	I <sub>SC</sub>			40	60		40	60	mA
Output Current	I <sub>SOURCE</sub>	V <sub>I(+)</sub> = 1V, V <sub>I(-)</sub> = 0V V <sub>CC</sub> = 15V	20	40		20	40		mA
		V <sub>I(+)</sub> = 0V, V <sub>I(-)</sub> = 1V V <sub>CC</sub> = 15V, V <sub>O(P)</sub> = 2V	10	20		10	20		mA
	I <sub>SINK</sub>	V <sub>I(+)</sub> = 0V, V <sub>I(-)</sub> = 1V V <sub>CC</sub> = 15V, V <sub>O(P)</sub> = 200mV	12	50		12	50		μ A
Differential Input Voltage	V <sub>I(DIFF)</sub>				V <sub>CC</sub>			V <sub>CC</sub>	V

## ELECTRICAL CHARACTERISTICS

(V<sub>CC</sub> = 5.0V, V<sub>EE</sub> = GND, unless otherwise specified)The following specifications apply over the range of -25°C ≤ T<sub>A</sub> ≤ +85°C for the KA224A; and the 0°C ≤ T<sub>A</sub> ≤ +70°C for the KA324A

Characteristic	Symbol	Test Conditions	KA224A			KA324A			Unit
			Min	Typ	Max	Min	Typ	Max	
Input Offset Voltage	V <sub>IO</sub>	V <sub>CM</sub> = 0V to V <sub>CC</sub> = 1.5V V <sub>O(P)</sub> = 1.4V, R <sub>S</sub> = 0Ω			4.0			5.0	mV
Input Offset Voltage Drift	Δ V <sub>IO</sub> /Δ T			7.0	20		7.0	30	μ V/°C
Input Offset Current	I <sub>IO</sub>				30			75	nA
Input Offset Current Drift	Δ I <sub>IO</sub> /Δ T			10	200		10	300	pA/°C
Input Bias Current	I <sub>BIAS</sub>			40	100		40	200	nA
Input Common-Mode Voltage Range	V <sub>I(R)</sub>	V <sub>CC</sub> = 30V	0		V <sub>CC</sub> -2.0	0		V <sub>CC</sub> -2.0	V
Large Signal Voltage Gain	G <sub>V</sub>	V <sub>CC</sub> = 15V, R <sub>L</sub> ≥ 2.0KΩ	25			15			V/mV
Output Voltage Swing	V <sub>O(P-P)</sub>	V <sub>CC</sub> = 30V							V
		R <sub>L</sub> = 2KΩ	26			26			
		R <sub>L</sub> = 10KΩ	27	28		27	28		
		V <sub>CC</sub> = 5V, R <sub>L</sub> ≤ 10KΩ		5	20		5	20	mA
Output Current	I <sub>SOURCE</sub>	V <sub>I(+)</sub> = 1V, V <sub>I(-)</sub> = 0V V <sub>CC</sub> = 15V	10	20		10	20		mA
	I <sub>SINK</sub>	V <sub>I(+)</sub> = 0V, V <sub>I(-)</sub> = 1V V <sub>CC</sub> = 15V	5	8		5	8		mA
Differential Input Voltage	V <sub>I(DIFF)</sub>				V <sub>CC</sub>			V <sub>CC</sub>	V

TYPICAL PERFORMANCE CHARACTERISTICS

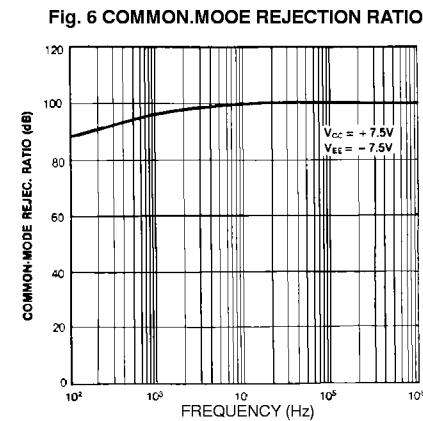
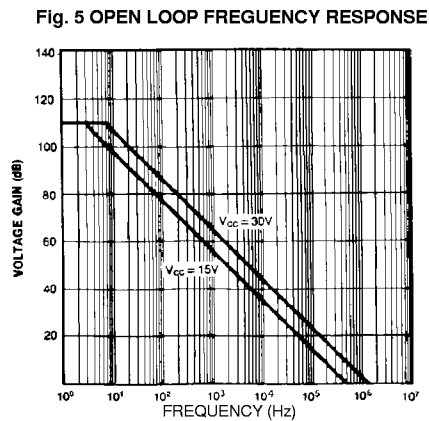
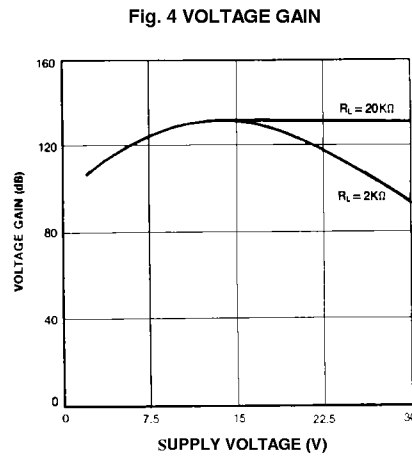
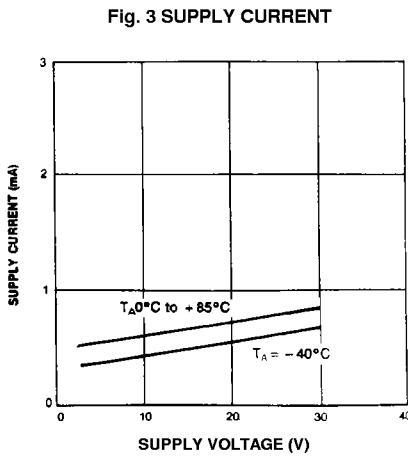
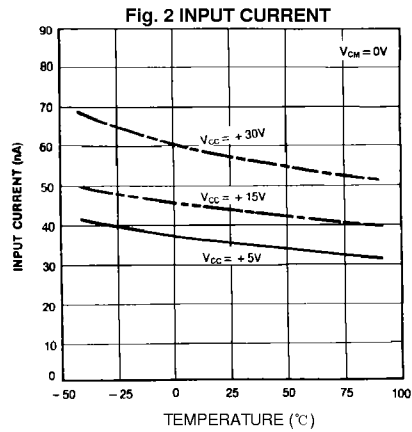
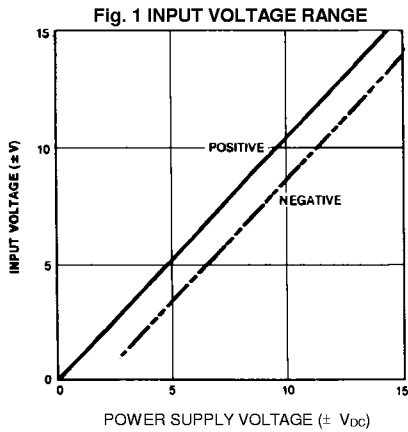

Fig. 7 SLEW RATE

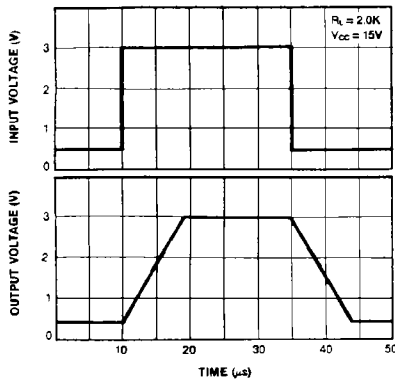

Fig. 8 VOLTAGE FOLLOWER PULSE RESPONSE (SMALL SIGNAL)

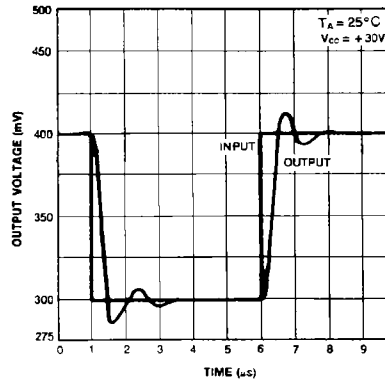

Fig. 9 LARGE SIGNAL FREQUENCY RESPONSE

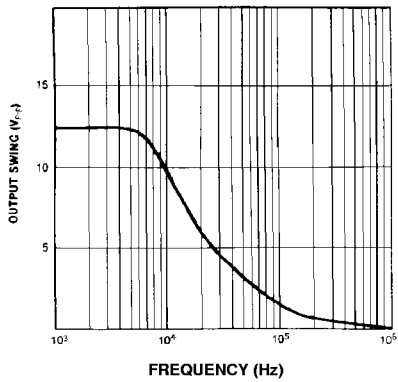

Fig. 10 OUTPUT CHARACTERISTICS CURRENT SOURCING

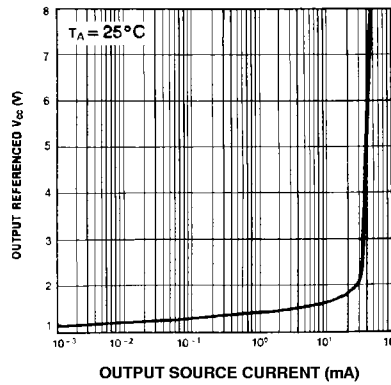

Fig. 11 OUTPUT CHARACTERISTICS CURRENT SINKING

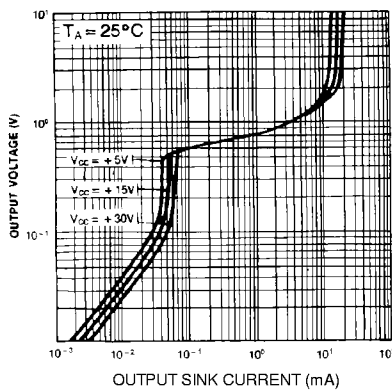
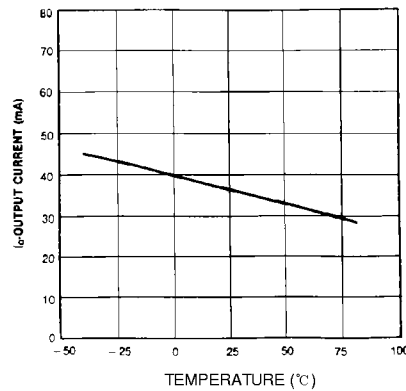

Fig. 12 CURRENT LIMITING



## TRADEMARKS

The following are registered and unregistered trademarks Fairchild Semiconductor owns or is authorized to use and is not intended to be an exhaustive list of all such trademarks.

ACE <sup>x</sup> ™	ISOPLANAR™	UHC™
CoolFET™	MICROWIRE™	VCX™
CROSSVOLT™	POP™	
E <sup>2</sup> CMOS™	PowerTrench™	
FACT™	QS™	
FACT Quiet Series™	Quiet Series™	
FAST®	SuperSOT™-3	
FAST <sub>r</sub> ™	SuperSOT™-6	
GTO™	SuperSOT™-8	
HiSeC™	TinyLogic™	

## DISCLAIMER

FAIRCHILD SEMICONDUCTOR RESERVES THE RIGHT TO MAKE CHANGES WITHOUT FURTHER NOTICE TO ANY PRODUCTS HEREIN TO IMPROVE RELIABILITY, FUNCTION OR DESIGN. FAIRCHILD DOES NOT ASSUME ANY LIABILITY ARISING OUT OF THE APPLICATION OR USE OF ANY PRODUCT OR CIRCUIT DESCRIBED HEREIN; NEITHER DOES IT CONVEY ANY LICENSE UNDER ITS PATENT RIGHTS, NOR THE RIGHTS OF OTHERS.

## LIFE SUPPORT POLICY

FAIRCHILD'S PRODUCTS ARE NOT AUTHORIZED FOR USE AS CRITICAL COMPONENTS IN LIFE SUPPORT DEVICES OR SYSTEMS WITHOUT THE EXPRESS WRITTEN APPROVAL OF FAIRCHILD SEMICONDUCTOR CORPORATION. As used herein:

1. Life support devices or systems are devices or systems which, (a) are intended for surgical implant into the body, or (b) support or sustain life, or (c) whose failure to perform when properly used in accordance with instructions for use provided in the labeling, can be reasonably expected to result in significant injury to the user.
2. A critical component is any component of a life support device or system whose failure to perform can be reasonably expected to cause the failure of the life support device or system, or to affect its safety or effectiveness.

## PRODUCT STATUS DEFINITIONS

### Definition of Terms

Datasheet Identification	Product Status	Definition
Advance Information	Formative or In Design	This datasheet contains the design specifications for product development. Specifications may change in any manner without notice.
Preliminary	First Production	This datasheet contains preliminary data, and supplementary data will be published at a later date. Fairchild Semiconductor reserves the right to make changes at any time without notice in order to improve design.
No Identification Needed	Full Production	This datasheet contains final specifications. Fairchild Semiconductor reserves the right to make changes at any time without notice in order to improve design.
Obsolete	Not In Production	This datasheet contains specifications on a product that has been discontinued by Fairchild semiconductor. The datasheet is printed for reference information only.