

Wide Supply Range Low Power RS232 Transceiver with 12V VPP Output for Flash Memory

FEATURES

- Generates Full RS232 Signal Levels from 3V Supply
- 12V VPP Output Available for Flash Memory
- Useful with a Wide Variety of Switching Regulators
- Low Supply Current: $I(V_{CC}) = 1\text{mA}$
- Wide Supply Range: $2\text{V} \leq V_{CC} \leq 6\text{V}$
- ESD Protection Over $\pm 10\text{kV}$
- Operates to 120k Baud
- Outputs Assume a High Impedance State When Off or Powered Down
- One μPower Receiver Remains Active While in SHUTDOWN
- Flowthrough Architecture Eases PC Board Layout
- $40\mu\text{A}$ Supply Current in SHUTDOWN
- Absolutely No Latch-Up
- Available in SO and SSOP Packages

APPLICATIONS

- Notebook and Palmtop Computers
- Mouse Driver Circuits

DESCRIPTION

The LT1332 is a 3-driver/5-receiver RS232 transceiver, designed to be used in conjunction with a switching regulator. The LT1332 shares the regulator's positive output, while charge is capacitively pumped from the regulator's switch pin to the negative supply. Schottky rectifiers built into the LT1332 simplify the charge pump design.

The LT1332/LT1109A combination shown below generates fully compliant RS232 signal levels from as little as 2V of input supply. The switcher can deliver greater than 100mA of output current, making the LT1332 an excellent choice for mouse driver circuits.

Advanced driver output stages operate up to 120k baud while driving heavy capacitive loads. New ESD structures on chip make the LT1332 resilient to multiple $\pm 10\text{kV}$ strikes, eliminating costly transient suppressors.

A shutdown pin disables the transceiver except for one receiver which remains active for detecting incoming RS232 signals. When shut down, the disabled drivers and receivers assume high impedance output states.

TYPICAL APPLICATION

LT1332 Powered from an LT1109A Micropower Switching Regulator
Configured for Flash Memory

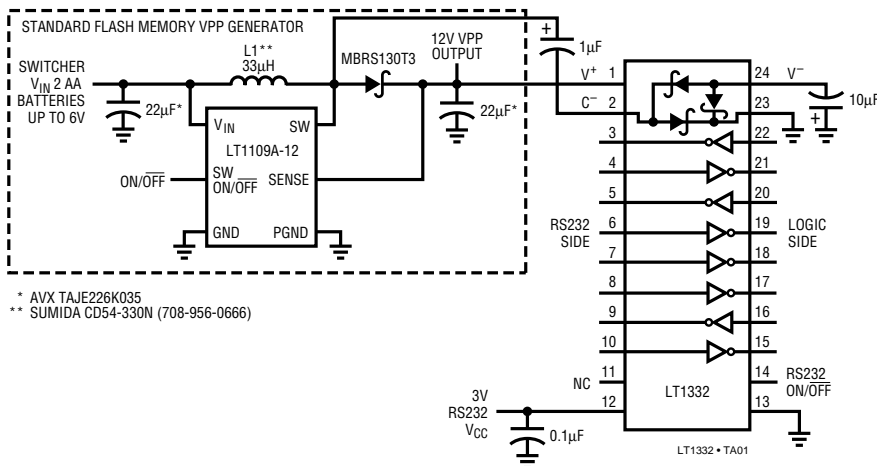

Output Waveforms

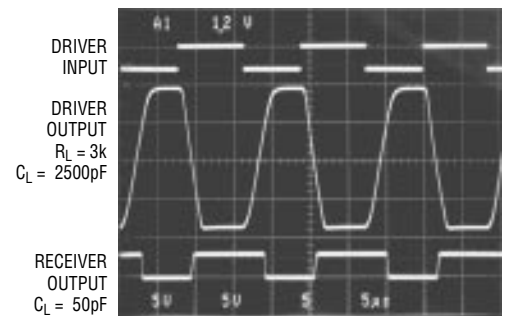

LT1332 • TA02

ABSOLUTE MAXIMUM RATINGS

(Note 1)

Supply Voltage (V_{CC})	6V	Short Circuit Duration	
V^+	13.2V	V^+	30 sec
V^-	-13.2V	V^-	30 sec
C^-	-15V	Driver Output	Indefinite
Input Voltage		Receiver Output	Indefinite
Driver	V^+ to V^-	Operating Temperature Range	0°C to 70°C
Receiver	30V to -30V	Storage Temperature Range	-65°C to 150°C
Output Voltage		Lead Temperature (Soldering, 10 sec)	300°C
Driver	30V to -30V		
Receiver	-0.3V to $V_{CC} + 0.3V$		

PACKAGE/ORDER INFORMATION

<p>TOP VIEW</p> <p>G PACKAGE 28-LEAD SSOP $T_{JMAX} = 150^{\circ}C, \theta_{JA} = 96^{\circ}C/W$</p>	<p>TOP VIEW</p> <p>N PACKAGE 28-LEAD PLASTIC DIP $T_{JMAX} = 150^{\circ}C, \theta_{JA} = 56^{\circ}C/W$</p>	<p>TOP VIEW</p> <p>S PACKAGE 24-LEAD PLASTIC SOL $T_{JMAX} = 150^{\circ}C, \theta_{JA} = 80^{\circ}C/W$</p>
ORDER PART NUMBER	ORDER PART NUMBER	ORDER PART NUMBER
LT1332CG	LT1332CN	LT1332CS

Consult factory for Industrial and Military grade parts.

ELECTRICAL CHARACTERISTICS (Note 2)

PARAMETER	CONDITIONS	MIN	TYP	MAX	UNITS
Power Supply					
Supply Current $I(V^+)$	(Note 3)		0.3	0.8	mA
Supply Current $I(V^-)$	(Note 3)		-0.6	-1.0	mA
Supply Current $I(V_{CC})$	(Note 3)		1.0	1.5	mA
Supply Current When OFF $I(V_{CC})$	(Note 4)	●	0.04	0.10	mA
			0.04	0.07	mA
Supply Current When OFF $I(V^+)$	$V_{CC} = 3V, V^+ = 8V, V_{ON/OFF} = 0.1V$		0.10	0.20	mA
Supply Current When OFF $I(V^-)$	$V_{CC} = 3V, V^- = -8V, V_{ON/OFF} = 0.1V$		0.10	0.20	mA

ELECTRICAL CHARACTERISTICS (Note 2)

PARAMETER	CONDITIONS		MIN	TYP	MAX	UNITS
Power Supply						
ON/OFF Pin Thresholds	Input Low Level (Device Shut Down)	●		0.7	0.3	V
	Input High Level (Device Enabled)	●	1.3	0.6		V
ON/OFF Pin Current	$0V \leq V_{ON/OFF} \leq 5V$	●	-15		80	μA
Drivers						
Output Voltage Swing	$R_L = 3k$ to GND Positive	●	5.0	6.6		V
	Negative	●		-7.0	-5.0	V
Logic Input Voltage Level	Input Low Level ($V_{OUT} = \text{High}$)	●		1.4	0.8	V
	Input High Level ($V_{OUT} = \text{Low}$)	●	2.0	1.4		V
Logic Input Current	$0.8V \leq V_{IN} \leq 2.0V$	●		5	20	μA
Output Short-Circuit Current	$V_{OUT} = 0V$			± 17		mA
Output Leakage Current	SHUTDOWN $V_{OUT} = \pm 30V$, $V_{ON/OFF} = 0.1V$	●		10	100	μA
Driver Output ESD Rating	Human Body Model Discharge			± 10		kV
Slew Rate	$R_L = 3k$, $C_L = 51pF$			15	30	V/ μs
	$R_L = 3k$, $C_L = 2500pF$		4	6		V/ μs
Propagation Delay	Output Transition t_{PHL} High to Low (Note 5)			0.6	1.3	μs
	Output Transition t_{PLH} Low to High			0.5	1.3	μs
Receivers						
Input Voltage Thresholds	Input Low Threshold ($V_{OUT} = \text{High}$)		0.8	1.3		V
	Input High Threshold ($V_{OUT} = \text{Low}$)			1.7	2.4	V
Hysteresis		●	0.1	0.4	1.0	V
Input Resistance			3	5	7	k Ω
Receiver Input ESD Rating	Human Body Model Discharge			± 10		kV
Output Voltage	Output Low, $I_{OUT} = -500\mu A$	●		0.2	0.4	V
	Output High, $I_{OUT} = 100\mu A$ ($V_{CC} = 3V$)	●	2.7	2.9		V
Output Leakage Current	SHUTDOWN (Note 6) $0 \leq V_{OUT} \leq V_{CC}$	●		1	10	μA
Output Short-Circuit Current	Sinking Current, $V_{OUT} = V_{CC}$			-4	-2	mA
	Sourcing Current, $V_{OUT} = 0V$		2	4		mA
Propagation Delay	Output Transition t_{HL} High to Low (Note 7)			1	3	μs
	Output Transition t_{LH} Low to High			0.6	3	μs

The ● denotes specifications which apply over the full operating temperature range.

Note 1: Absolute maximum ratings are those values beyond which the life of the device may be impaired.

Note 2: Testing is done at $V_{CC} = 3V$, $V^+ = 8V$, $V^- = -8V$, and $V_{ON/OFF} = 3V$.

Note 3: Supply current is measured with all driver inputs tied high.

Note 4: Supply current measurements in SHUTDOWN are performed with $V_{ON/OFF} = 0.1V$, $V^+ = 0V$, $V^- = 0V$.

Note 5: For driver delay measurements, $R_L = 3k$ and $C_L = 51pF$. Trigger points are set between the driver's input logic threshold and the output transition to the zero crossing ($t_{PHL} = 1.4V$ to $0V$ and $t_{PLH} = 1.4V$ to $0V$).

Note 6: Receiver RXA (Pins 10 and 15, S Package) remains functioning in SHUTDOWN.

Note 7: For receiver delay measurements, $C_L = 51pF$. Trigger points are set between the receiver's input logic threshold and the output transition to standard TTL/CMOS logic threshold ($t_{LH} = 1.3V$ to $2.4V$ and $t_{HL} = 1.7V$ to $0.8V$).

TYPICAL PERFORMANCE CHARACTERISTICS

Unloaded Supply Current vs Temperature

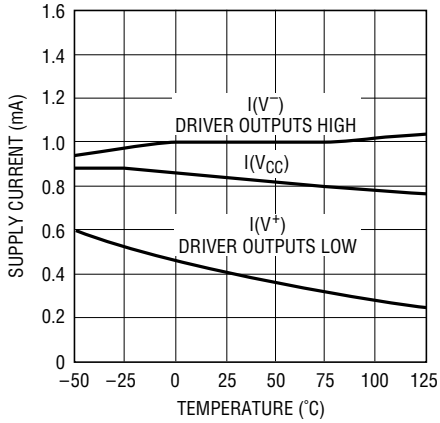

LT1332 • TPC01

Supply Current vs Data Rate

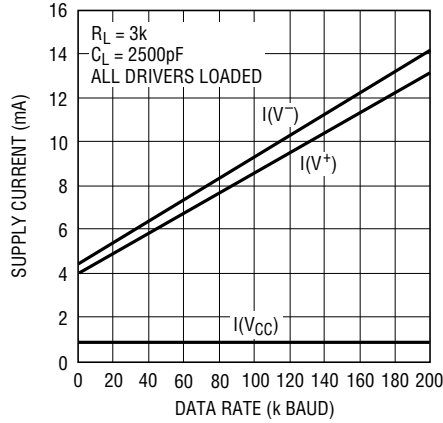

LT1332 • TPC02

ON/OFF Threshold vs Temperature

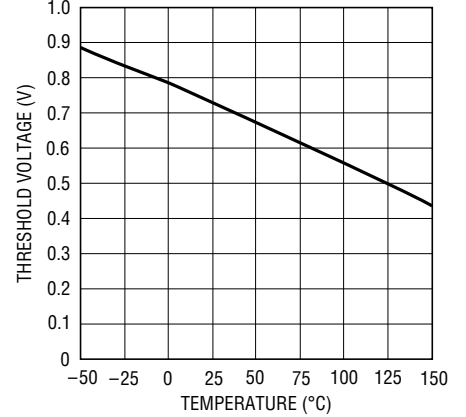

LT1332 • TPC03

Leakage Current in Shutdown vs Temperature

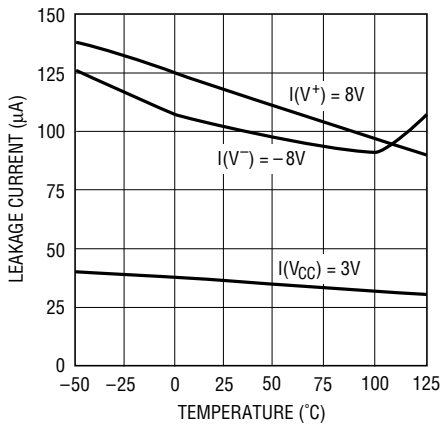

LT1027 • TPC04

Driver Leakage in Shutdown vs Temperature

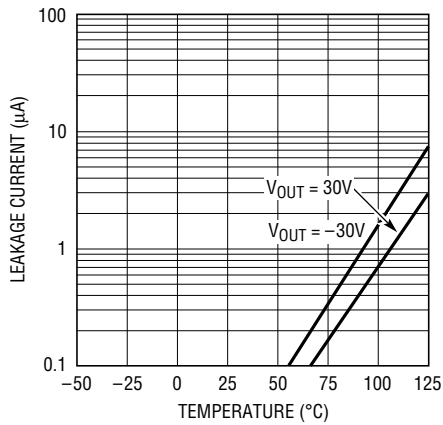

LT1332 • TPC05

Driver Short-Circuit Current vs Temperature

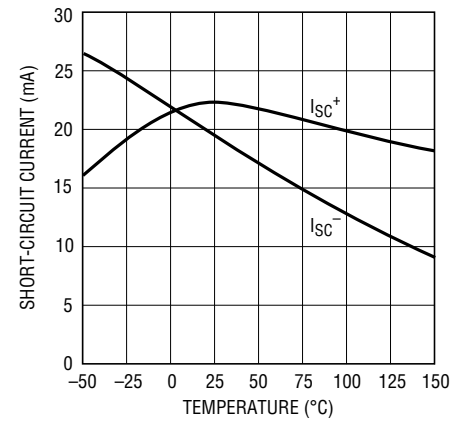

LT1332 • TPC06

Slew Rate vs Load Capacitance

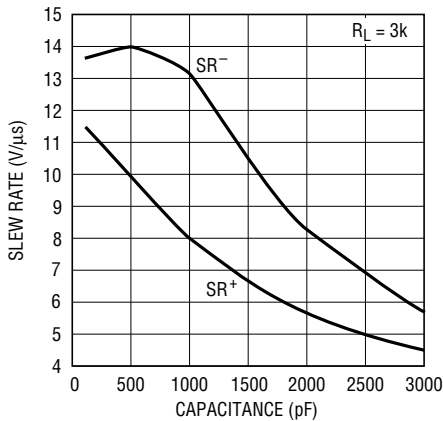

LT1332 • TPC07

Driver Output Voltage vs Temperature

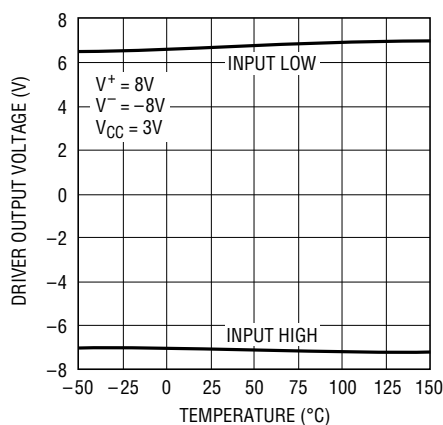

LT1332 • TPC08

Receiver Short-Circuit Current vs Temperature

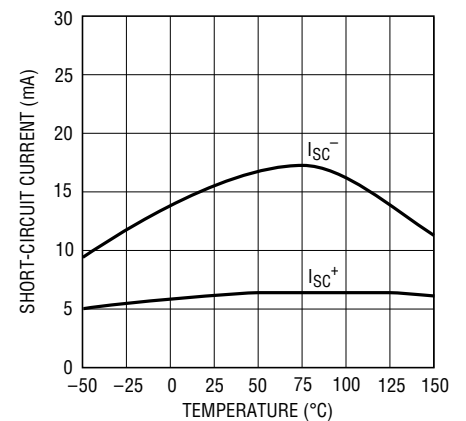

LT1332 • TPC09

TYPICAL PERFORMANCE CHARACTERISTICS

Receiver Input Thresholds vs Supply Voltage

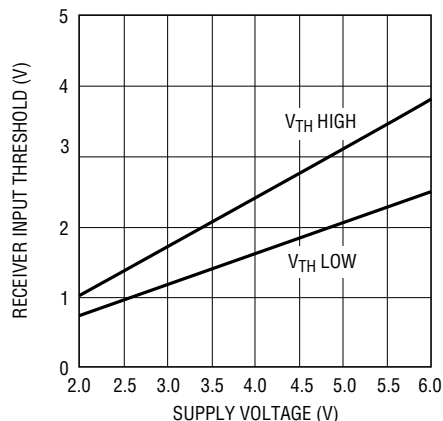

LT1332 • TPC10

Receiver Input Thresholds vs Temperature

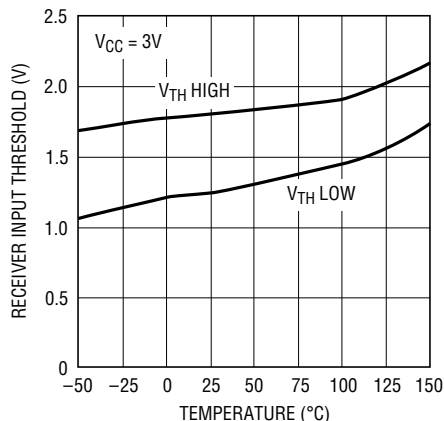

LT1332 • TPC11

Receiver Output Voltage vs Supply Voltage

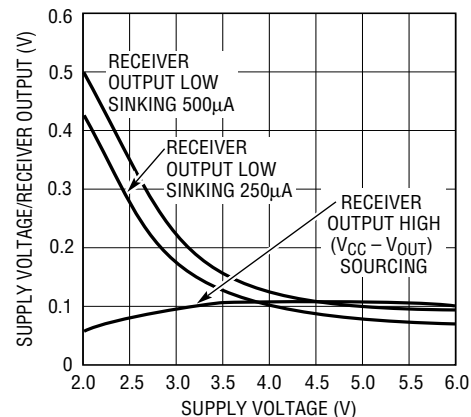

LT1332 • TPC12

Receiver Output Waveforms

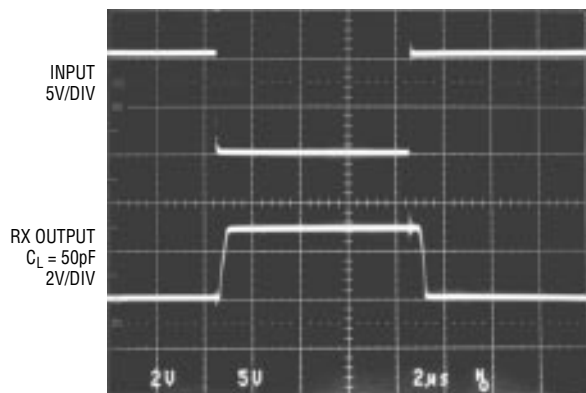

LT1332 • TPC13

Driver Output Waveforms

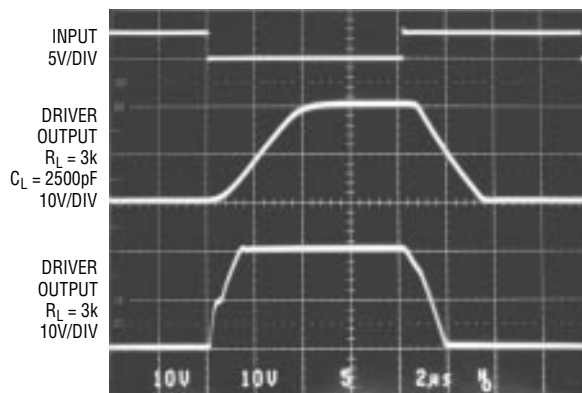

LT1332 • TPC13

PIN FUNCTIONS

V_{CC}: Input Supply Pin. V_{CC} can vary from 2V to 6V to accommodate a wide range of logic levels, yet the system still responds correctly to RS232 signals. Supply current drops to 40µA in the SHUTDOWN mode. This pin should be decoupled with a 0.1µF ceramic capacitor.

GND: Ground Pins. Pins 13 and 23 (S Package) must both be grounded for proper operation.

ON/OFF: Controls the operation mode of the device and is CMOS compatible. A logic low puts the device in the SHUTDOWN mode which reduces input supply current to 40µA and places all of the drivers and four of the receivers in a high impedance state. A logic high fully enables the device.

V⁺: Positive Supply Input (RS232 Drivers). V⁺ should be greater than 6.5V and less than 13.2V to assure valid RS232 output signals. An additional decoupling capacitor may be required if the V⁺ generator is located far away from the LT1332.

V⁻: Negative Supply Pin (RS232 Drivers). This pin requires an external capacitor. When the device is powered from a switching regulator, the filter capacitor should be selected based on the maximum tolerable ripple for the specified minimum regulator on time. For some low frequency Burst Mode™ regulators, the filter capacitor should be relatively large (C ≥ 10µF). Low ESR tantalum

Burst Mode™ is a trademark of Linear Technology Corporation

PIN FUNCTIONS

capacitors work well in this application. When V^- is powered from an external supply, the filter capacitor can be considerably smaller ($C \geq 0.1\mu\text{F}$). Ceramic capacitors work well under these conditions. V^- should be greater than -13.2V and less than -6.5V .

C⁻: Commutating Capacitor Input. When the LT1332 is used with a switching regulator, a charge pump capacitor should be connected from the regulator's switch pin to the C⁻ pin. Make the external capacitor $1\mu\text{F}$ or larger with low effective series resistance to maintain good charge pump efficiency. Low ESR tantalum capacitors ($\text{ESR} < 2\Omega$) work well in this application. The C⁻ pin should be left open when V^- is powered from an external supply.

DRIVER IN: RS232 Driver Input Pins. Inputs are TTL/CMOS compatible, with threshold set to 1.2V. Unused inputs should not float; tie them to V_{CC} .

DRIVER OUT: Driver Outputs at RS232 Voltage Levels. Outputs are in a high impedance state when in SHUTDOWN mode, or $V_{\text{CC}} = 0\text{V}$. Outputs are fully short-circuit protected from $V^- + 30\text{V}$ to $V^+ - 30\text{V}$ with the power on, off or SHUTDOWN. Typical breakdowns are $\pm 45\text{V}$. Applying higher voltages will not damage the device if the overdrive is moderately current limited. Although the outputs are protected, short circuits on one output

can load the power supply generator and may disrupt the signal levels of the other outputs. The driver outputs are protected against ESD to $\pm 10\text{kV}$ for human body model discharges.

RX IN: Receiver Inputs. These pins accept RS232 level signals ($\pm 5\text{V}$ to $\pm 30\text{V}$) into a protected 5k terminating resistor. The receiver inputs are protected against ESD to $\pm 10\text{kV}$ for human body model discharges. Each receiver provides 0.4V of hysteresis for noise immunity. The receiver thresholds are specified at $V_{\text{CC}} = 3\text{V}$. When V_{CC} varies from 2V to 6V, the lower threshold increases about 3V. Regardless of these shifts, the device provides accurate data from valid RS232 input signals. A graph in the performance characteristics section shows typical changes in the thresholds. The active receiver (RXA, Pin 10, S Package) remains functional in SHUTDOWN.

RX OUT: Receiver Outputs with TTL/CMOS Voltage Levels. Outputs are in a high impedance stage when in SHUTDOWN mode to allow data line sharing. Outputs are fully short-circuit protected to ground or V_{CC} with the power on, off or in SHUTDOWN mode. The active receiver (RXA, Pin 15, S Package) remains functional in SHUTDOWN.

ESD PROTECTION

The RS232 line inputs of the LT1332 have on-chip protection from ESD transients up to $\pm 10\text{kV}$. The protection structures act to divert the static discharge safely to system ground. In order for the ESD protection to function effectively, the power supply and ground pins of the LT1332 must be connected to ground through low impedances. The power supply decoupling capacitors and charge pump storage capacitors provide this low impedance in normal applications of the circuit. The only constraint is that low ESR capacitors must be used for bypassing and charge storage. ESD testing must be done with pins V_{CC} , V^+ , V^- and GND shorted to ground or connected with low ESR capacitors.

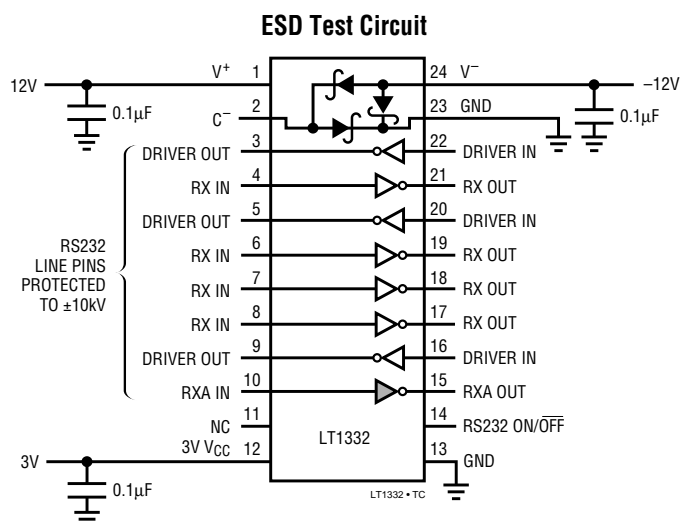

APPLICATIONS INFORMATION

Operation with a Switching Regulator

The LT1332 is designed to be powered from an external switching regulator which may be used elsewhere for power conditioning. In a typical application, the LT1332 shares the regulator's positive output, while charge is capacitively pumped from the regulator's switch pin to the negative supply. Schottky rectifiers built into the LT1332 simplify the charge pump design. When used with a micropower switcher like the LT1109A, the Burst Mode™ operation of the charge pump resembles the switching characteristics of the LT1237 and similar devices.

The V^- supply is not directly regulated. The circuit relies on cross regulation and the regulator's minimum duty cycle to control V^- . Select the C^- and V^- storage capacitors so that when the regulator operates at minimum duty cycle, sufficient charge will transfer to the V^- storage cap to maintain a voltage of at least $-6.5V$.

While only $0.1\mu F$ ceramic decoupling capacitors are needed on the positive supply inputs, low ESR tantalum capaci-

tors should be used in the charge pump to reduce voltage losses. The C^- capacitor should be at least $1\mu F$ and the V^- capacitor should be 5 to 10 times bigger. As a rule of thumb, make the V^- capacitor at least $1/DC_{MIN}$ times bigger than the C^- capacitor where DC_{MIN} is the regulator's minimum duty cycle. Using large values for the V^- capacitor reduces ripple on the V^- supply.

Multiple Transceivers

The circuit in Figure 1 demonstrates how the LT1332 may be used with different types of switching regulators. Four LT1332s are powered from a single PWM DC/DC converter using an LT1172. Even with all twelve drivers heavily loaded ($R_L = 3k$, $C_L = 2500pF$), the circuit generates fully compliant RS232 signals at 120k baud.

Operations with External Supplies

When external RS232 supplies are available ($6.5V \leq V^+ \leq 13.2V$, $-13.2V \leq V^- \leq -6.2V$) the LT1332 can be used as a stand-alone unit. Capacitor selection is consider-

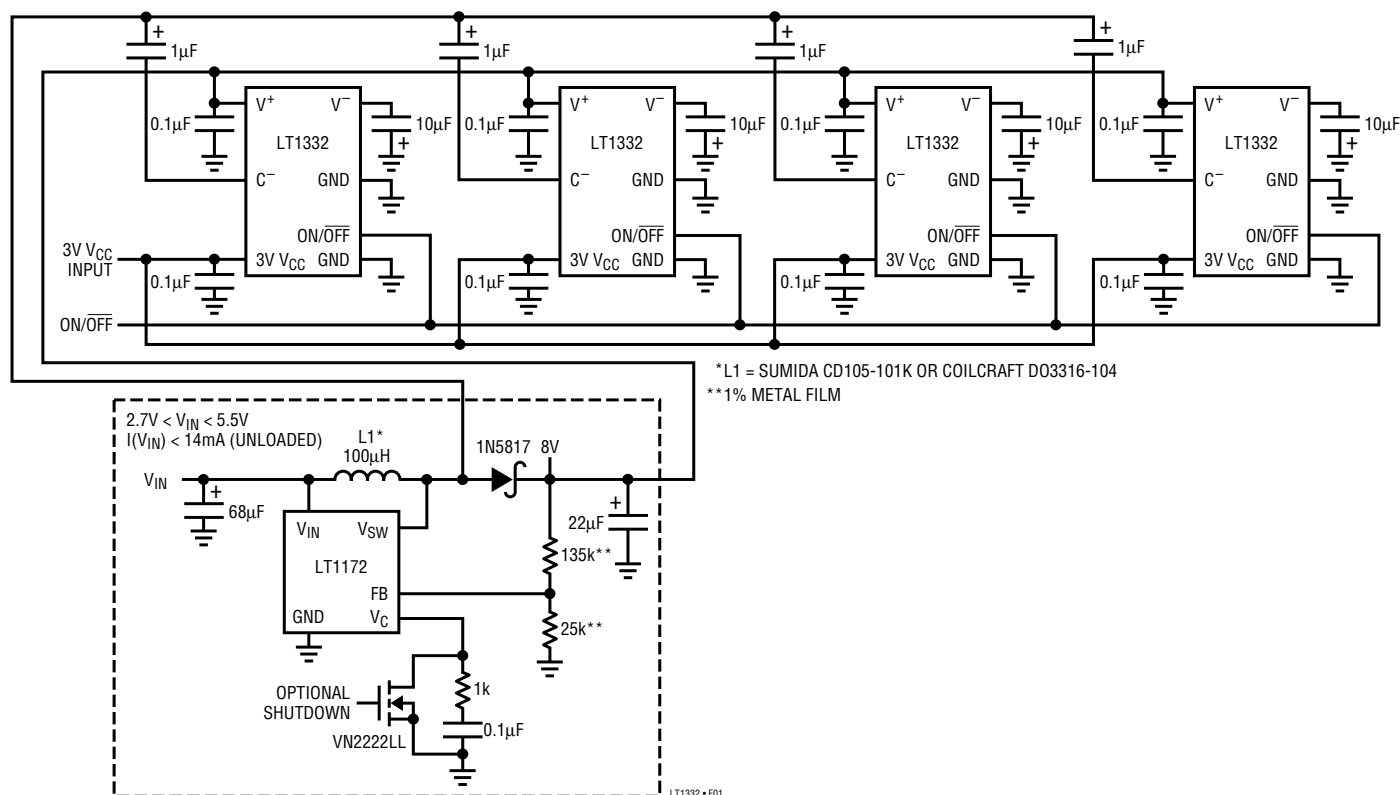

Figure 1. Multiple LT1332s Powered from a Single LT1172 DC/DC Converter

APPLICATIONS INFORMATION

ably simpler. Decouple V^+ and V^- with $0.1\mu\text{F}$ ceramic capacitors.

Shutdown Control

The LT1332 has an $\text{ON}/\overline{\text{OFF}}$ pin that controls the device's mode of operation. With the $\text{ON}/\overline{\text{OFF}}$ pin high and the device operated unloaded, the LT1332 draws 1mA of supply current. With the $\text{ON}/\overline{\text{OFF}}$ pin low, the device

enters micropower shutdown mode in which the current drawn from V_{CC} drops to typically $40\mu\text{A}$. If the power applied to V^+ and V^- remains on in shutdown, there will be approximately $100\mu\text{A}$ of leakage from each supply. If these supplies drop to zero, leakage current also drops to zero. In shutdown mode one receiver remains active which may be useful for detecting start-up signals for the transceiver.

PACKAGE DESCRIPTION Dimensions in inches (millimeters) unless otherwise noted.

G Package 28-Lead Plastic SSOP

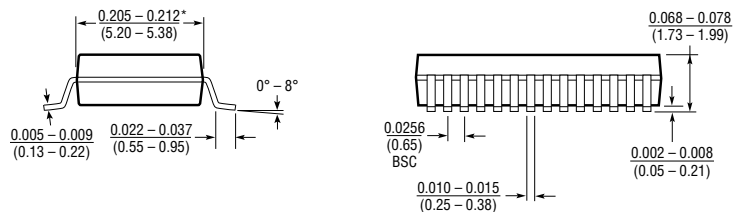

*THESE DIMENSIONS DO NOT INCLUDE MOLD FLASH OR PROTRUSIONS. MOLD FLASH OR PROTRUSIONS SHALL NOT EXCEED 0.006 INCH (0.15mm).

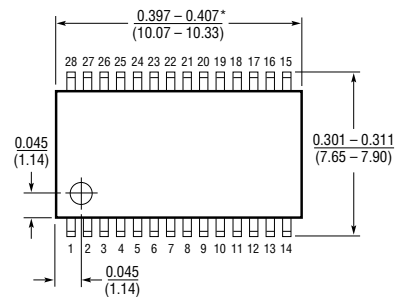

N Package 28-Lead Plastic DIP

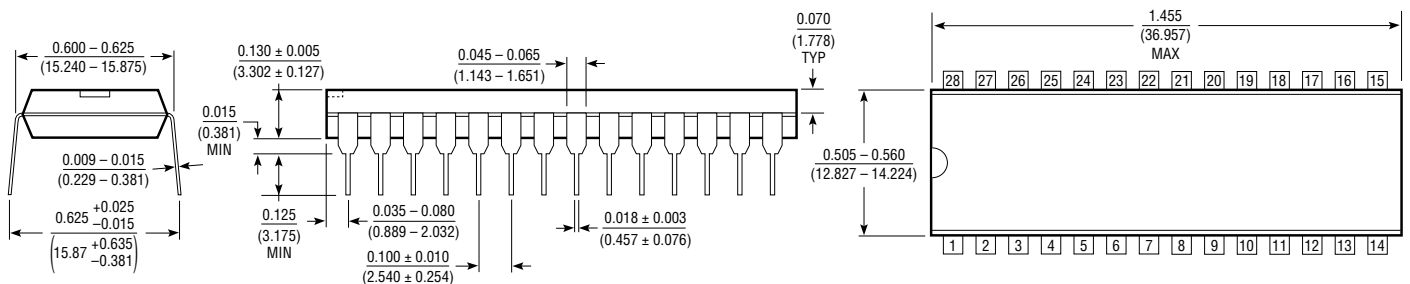

S Package 24-Lead Plastic SOL

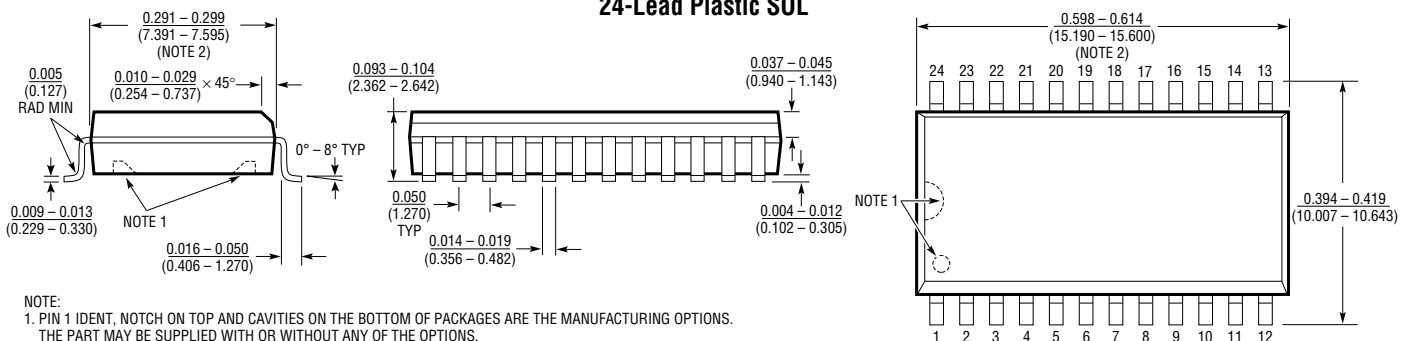

NOTE:
1. PIN 1 IDENT, NOTCH ON TOP AND CAVITIES ON THE BOTTOM OF PACKAGES ARE THE MANUFACTURING OPTIONS. THE PART MAY BE SUPPLIED WITH OR WITHOUT ANY OF THE OPTIONS.
2. THESE DIMENSIONS DO NOT INCLUDE MOLD FLASH OR PROTRUSIONS. MOLD FLASH OR PROTRUSIONS SHALL NOT EXCEED 0.006 INCH (0.15mm).