

IRG4BC20MD

INSULATED GATE BIPOLAR TRANSISTOR WITH
ULTRAFAST SOFT RECOVERY DIODE

Short Circuit Rated
Fast IGBT

Features

- Rugged: 10μsec short circuit capable at $V_{GS}=15V$
- Low $V_{CE(on)}$ for 4 to 10kHz applications
- IGBT Co-packaged with ultra-soft-recovery antiparallel diode
- Industry standard TO-220AB package

Benefits

- Offers highest efficiency and short circuit capability for intermediate applications
- Provides best efficiency for the mid range frequency (4 to 10kHz)
- Optimized for Appliance Motor Drives, Industrial (Short Circuit Proof) Drives and Intermediate Frequency Range Drives
- High noise immune "Positive Only" gate drive- Negative bias gate drive not necessary
- For Low EMI designs- requires little or no snubbing
- Single Package switch for bridge circuit applications
- Compatible with high voltage Gate Driver IC's
- Allows simpler gate drive

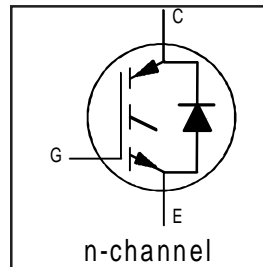

$V_{CES} = 600V$
$V_{CE(on)} \text{ typ.} = 1.85V$
@ $V_{GE} = 15V, I_C = 11A$

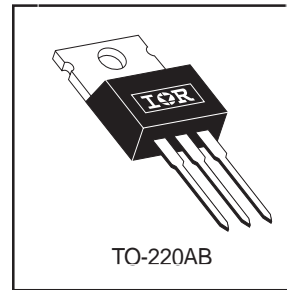

Absolute Maximum Ratings

	Parameter	Max.	Units
V_{CES}	Collector-to-Emitter Voltage	600	V
$I_C @ T_C = 25^\circ C$	Continuous Collector Current	18	A
$I_C @ T_C = 100^\circ C$	Continuous Collector Current	11	
I_{CM}	Pulsed Collector Current ①	36	
I_{LM}	Clamped Inductive Load Current ②	36	
$I_F @ T_C = 100^\circ C$	Diode Continuous Forward Current	7.0	
t_{sc}	Short Circuit Withstand Time	10	μs
I_{FM}	Diode Maximum Forward Current	36	A
V_{GE}	Gate-to-Emitter Voltage	± 20	V
$P_D @ T_C = 25^\circ C$	Maximum Power Dissipation	60	W
$P_D @ T_C = 100^\circ C$	Maximum Power Dissipation	24	
T_J	Operating Junction and	-55 to +150	°C
T_{STG}	Storage Temperature Range		
	Soldering Temperature, for 10 sec.	300 (0.063 in. (1.6mm) from case)	
	Mounting Torque, 6-32 or M3 Screw.	10 lbf•in (1.1 N•m)	

Thermal Resistance

	Parameter	Min.	Typ.	Max.	Units
$R_{\theta JC}$	Junction-to-Case - IGBT	-----	-----	2.1	°C/W
$R_{\theta JC}$	Junction-to-Case - Diode	-----	-----	2.5	
$R_{\theta CS}$	Case-to-Sink, flat, greased surface	-----	0.50	-----	
$R_{\theta JA}$	Junction-to-Ambient, typical socket mount	-----	-----	80	
Wt	Weight	-----	2 (0.07)	-----	g (oz)

Electrical Characteristics @ $T_J = 25^\circ\text{C}$ (unless otherwise specified)

	Parameter	Min.	Typ.	Max.	Units	Conditions
$V_{(BR)CES}$	Collector-to-Emitter Breakdown Voltage ^③	600	----	----	V	$V_{GE} = 0V, I_C = 250\mu A$
$\Delta V_{(BR)CES}/\Delta T_J$	Temperature Coeff. of Breakdown Voltage	----	0.67	----	$V/^\circ\text{C}$	$V_{GE} = 0V, I_C = 1.0mA$
$V_{CE(on)}$	Collector-to-Emitter Saturation Voltage	----	1.85	2.1	V	$I_C = 11A, V_{GE} = 15V$ $I_C = 18A$ $I_C = 11A, T_J = 150^\circ\text{C}$ See Fig. 2, 5
		----	2.46	----		
		----	2.07	----		
$V_{GE(th)}$	Gate Threshold Voltage	4.0	----	6.5		$V_{CE} = V_{GE}, I_C = 250\mu A$
$\Delta V_{GE(th)}/\Delta T_J$	Temperature Coeff. of Threshold Voltage	----	-11	----	$mV/^\circ\text{C}$	$V_{CE} = V_{GE}, I_C = 250\mu A$
g_{fe}	Forward Transconductance ^④	3.0	3.6	----	S	$V_{CE} = 100V, I_C = 11A$
I_{CES}	Zero Gate Voltage Collector Current	----	----	250	μA	$V_{GE} = 0V, V_{CE} = 600V$ $V_{GE} = 0V, V_{CE} = 600V, T_J = 150^\circ\text{C}$
		----	----	2500		
V_{FM}	Diode Forward Voltage Drop	----	1.4	1.7	V	$I_C = 8.0A$ $I_C = 8.0A, T_J = 150^\circ\text{C}$ See Fig. 13
		----	1.3	1.6		
I_{GES}	Gate-to-Emitter Leakage Current	----	----	± 100	nA	$V_{GE} = \pm 20V$

Switching Characteristics @ $T_J = 25^\circ\text{C}$ (unless otherwise specified)

	Parameter	Min.	Typ.	Max.	Units	Conditions
Q_g	Total Gate Charge (turn-on)	----	39	59	nC	$I_C = 11A$ $V_{CC} = 400V$ $V_{GE} = 15V$ See Fig. 8
Q_{ge}	Gate - Emitter Charge (turn-on)	----	5.3	8.0		
Q_{gc}	Gate - Collector Charge (turn-on)	----	20	30		
$t_{d(on)}$	Turn-On Delay Time	----	21	----	ns	$T_J = 25^\circ\text{C}$ $I_C = 11A, V_{CC} = 480V$ $V_{GE} = 15V, R_G = 50\Omega$ Energy losses include "tail" and diode reverse recovery. See Fig. 9, 10, 11, 18
t_r	Rise Time	----	37	----		
$t_{d(off)}$	Turn-Off Delay Time	----	463	690		
t_f	Fall Time	----	340	510		
E_{on}	Turn-On Switching Loss	----	0.41	----	mJ	See Fig. 9, 10, 11, 18
E_{off}	Turn-Off Switching Loss	----	2.03	----		
E_{ts}	Total Switching Loss	----	2.44	3.7		
$t_{d(on)}$	Turn-On Delay Time	----	19	----	ns	$T_J = 150^\circ\text{C}$, See Fig. 9, 10, 11, 18 $I_C = 6.5A, V_{CC} = 480V$ $V_{GE} = 15V, R_G = 50\Omega$ Energy losses include "tail" and diode reverse recovery.
t_r	Rise Time	----	41	----		
$t_{d(off)}$	Turn-Off Delay Time	----	590	----		
t_f	Fall Time	----	600	----		
E_{ts}	Total Switching Loss	----	3.49	----	mJ	Measured 5mm from package
L_E	Internal Emitter Inductance	----	7.5	----	nH	
C_{ies}	Input Capacitance	----	460	----	pF	$V_{GE} = 0V$ $V_{CC} = 30V$ $f = 1.0MHz$ See Fig. 7
C_{oes}	Output Capacitance	----	54	----		
C_{res}	Reverse Transfer Capacitance	----	14	----		
t_{rr}	Diode Reverse Recovery Time	----	37	55	ns	$T_J = 25^\circ\text{C}$ See Fig. 14 $T_J = 125^\circ\text{C}$ 14
		----	55	90		
I_{rr}	Diode Peak Reverse Recovery Current	----	3.5	5.0	A	$T_J = 25^\circ\text{C}$ See Fig. 15 $T_J = 125^\circ\text{C}$ 15
		----	4.5	8.0		
Q_{rr}	Diode Reverse Recovery Charge	----	65	138	nC	$T_J = 25^\circ\text{C}$ See Fig. 16 $T_J = 125^\circ\text{C}$ 16
		----	124	360		
$di_{(rec)M}/dt$	Diode Peak Rate of Fall of Recovery During t_b	----	240	----	A/ μs	$T_J = 25^\circ\text{C}$ See Fig. 17 $T_J = 125^\circ\text{C}$ 17
		----	210	----		

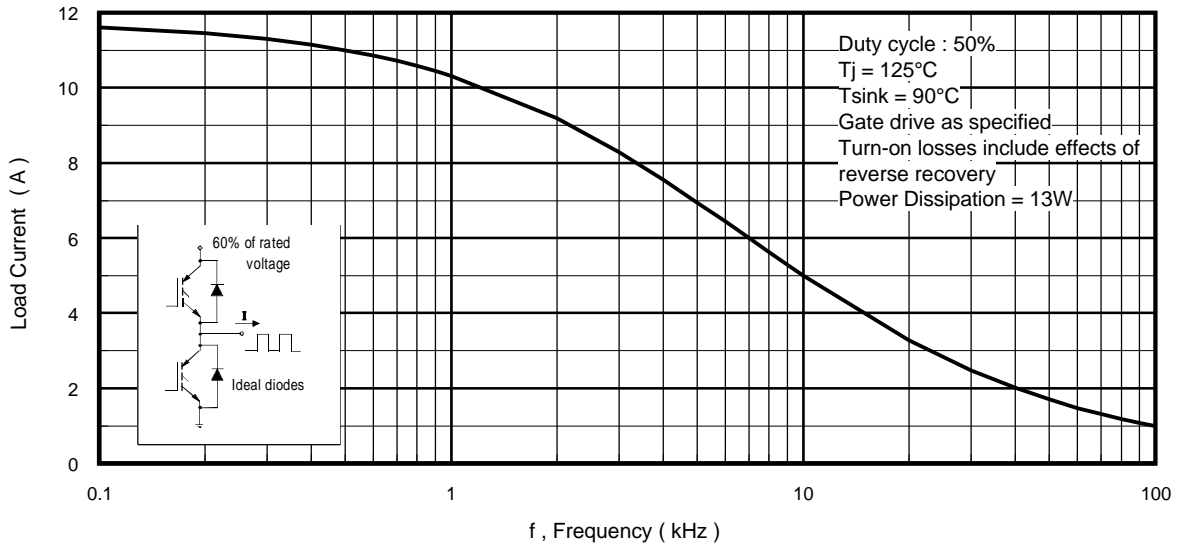

Fig. 1 - Typical Load Current vs. Frequency
 (Load Current = I_{RMS} of fundamental)

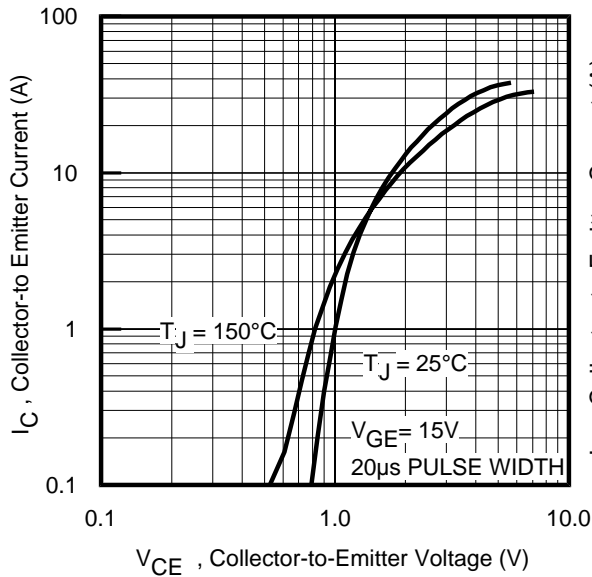

Fig. 2 - Typical Output Characteristics

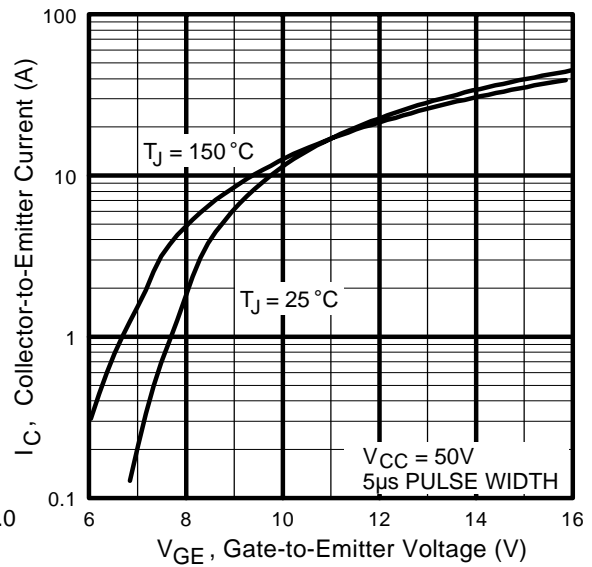

Fig. 3 - Typical Transfer Characteristics

IRG4BC20MD

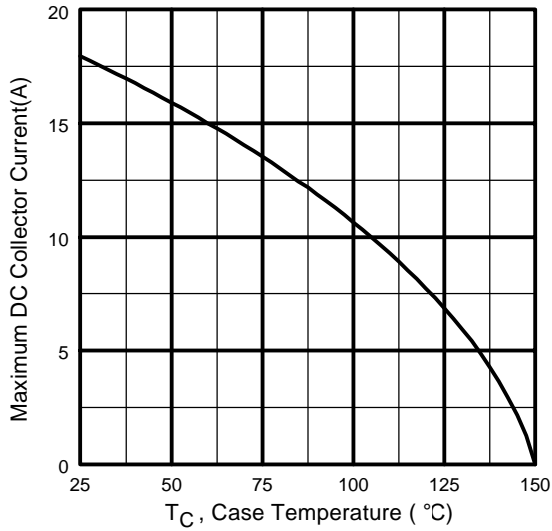

Fig. 4 - Maximum Collector Current vs. Case Temperature

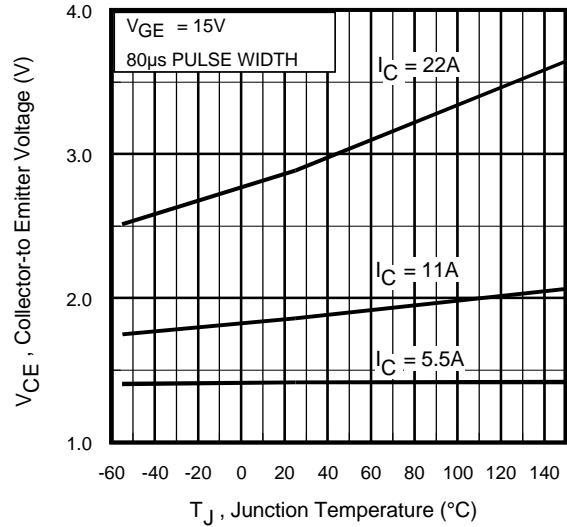

Fig. 5 - Typical Collector-to-Emitter Voltage vs. Junction Temperature

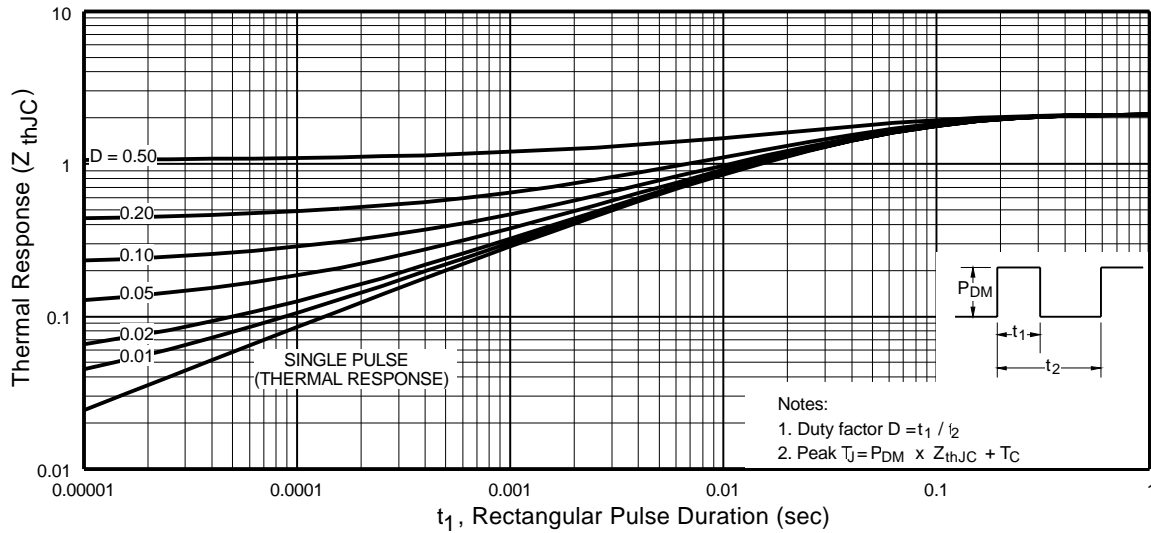

Fig. 6 - Maximum IGBT Effective Transient Thermal Impedance, Junction-to-Case

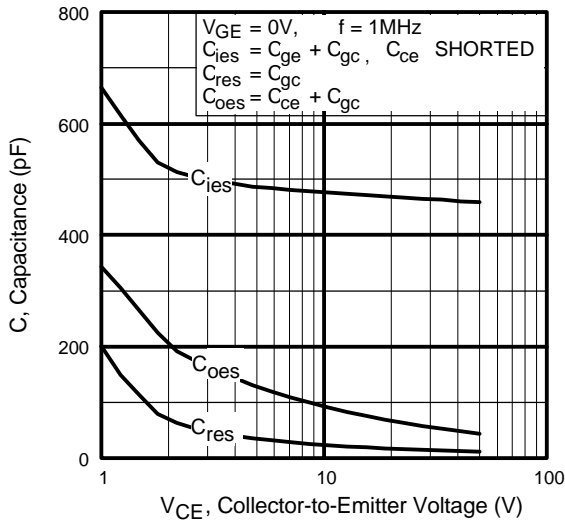

Fig. 7 - Typical Capacitance vs. Collector-to-Emitter Voltage

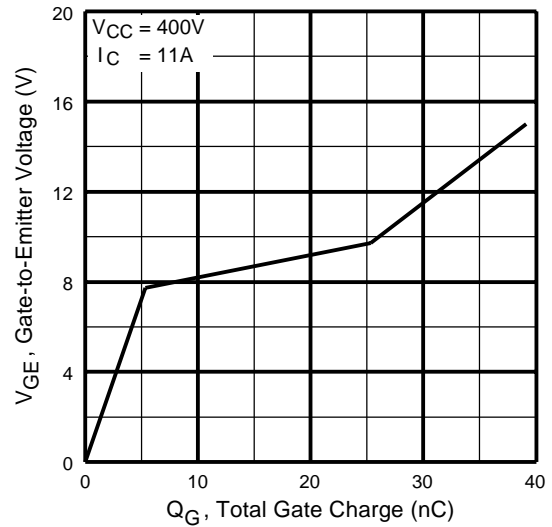

Fig. 8 - Typical Gate Charge vs. Gate-to-Emitter Voltage

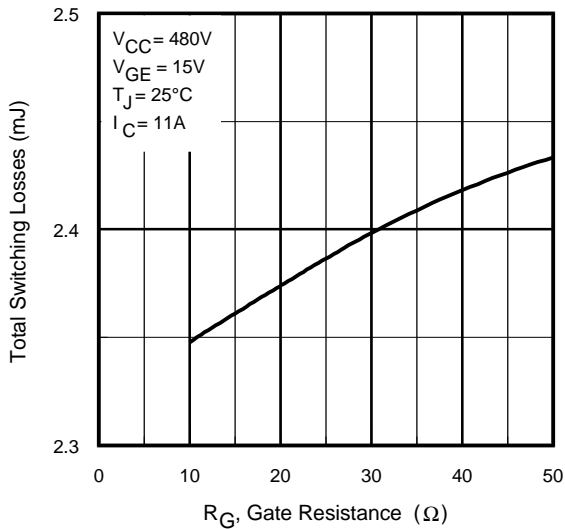

Fig. 9 - Typical Switching Losses vs. Gate Resistance

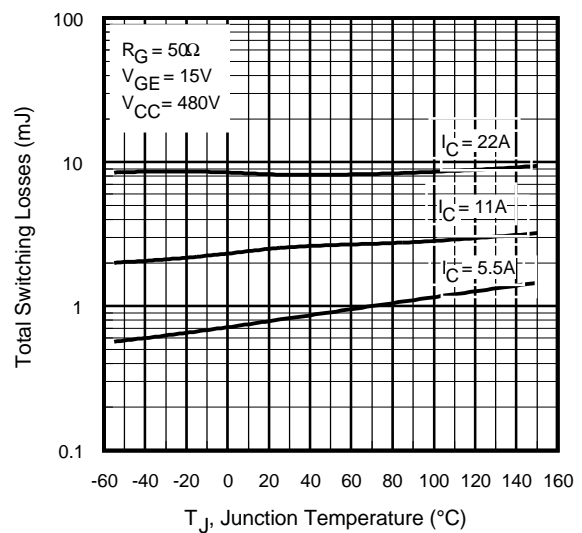

Fig. 10 - Typical Switching Losses vs. Junction Temperature

IRG4BC20MD

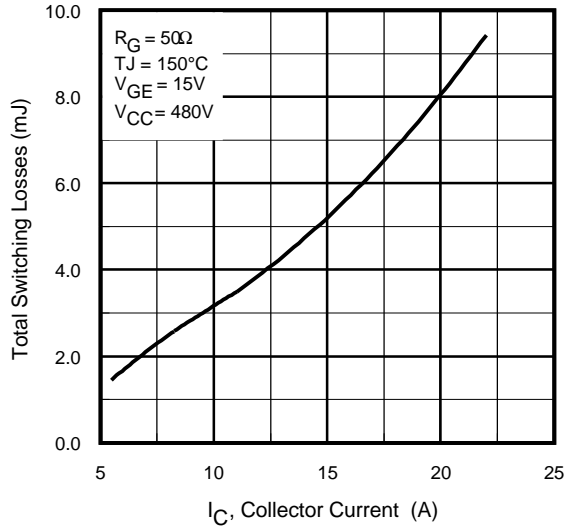

Fig. 11 - Typical Switching Losses vs. Collector-to-Emitter Current

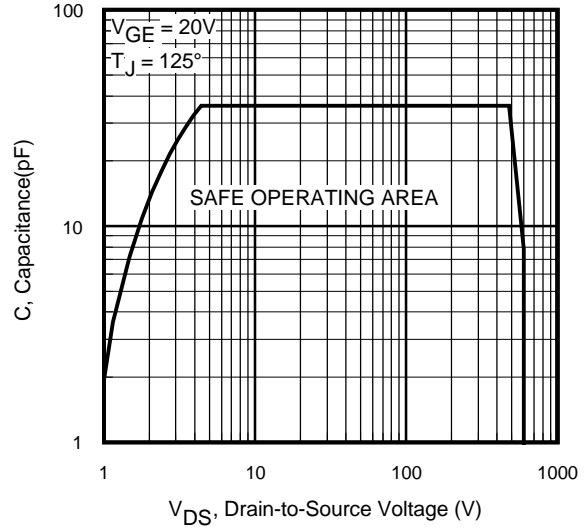

Fig. 12 - Turn-Off SOA

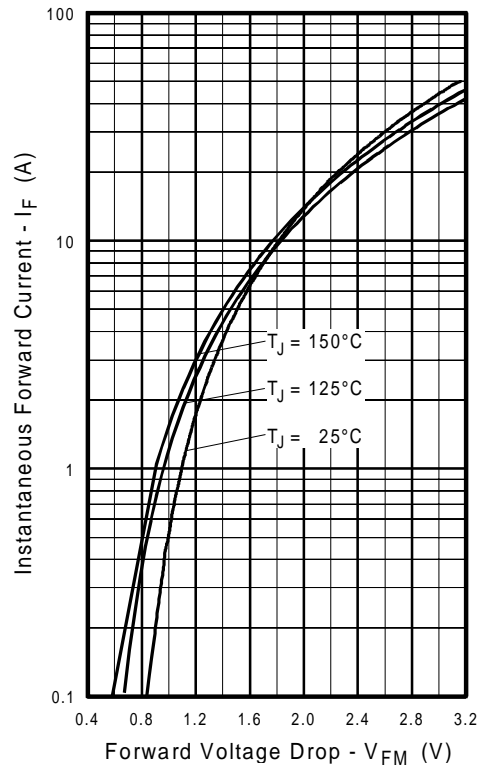

Fig. 13 - Maximum Forward Voltage Drop vs. Instantaneous Forward Current

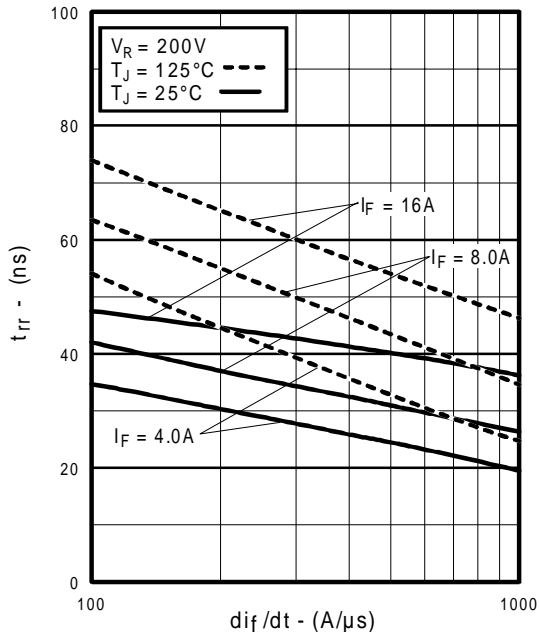

Fig. 14 - Typical Reverse Recovery vs. di_f/dt

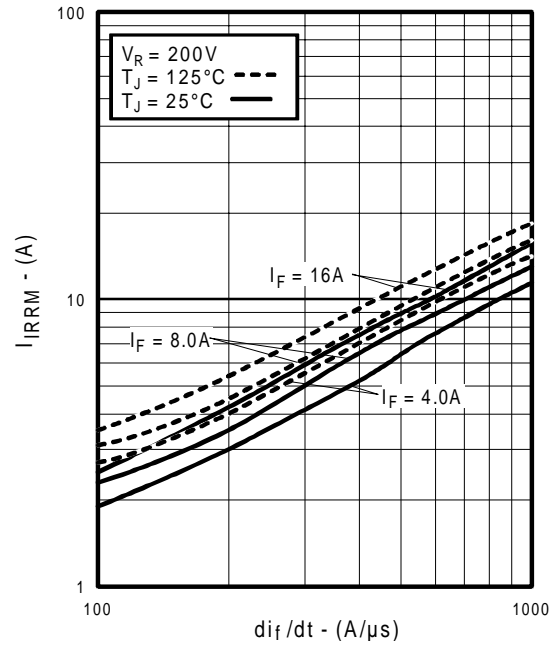

Fig. 15 - Typical Recovery Current vs. di_f/dt

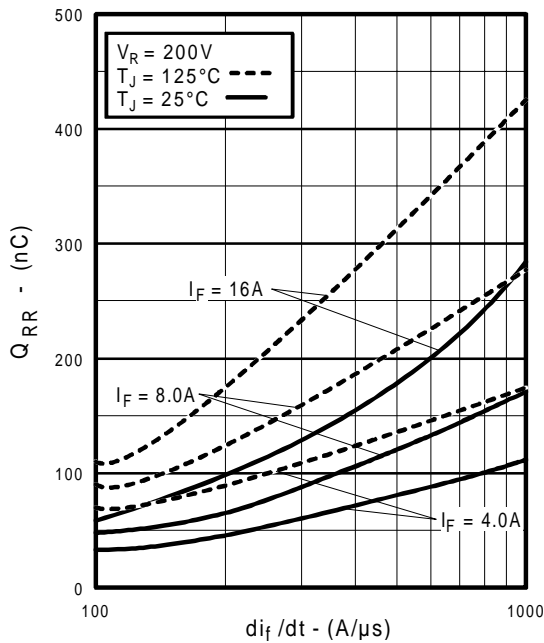

Fig. 16 - Typical Stored Charge vs. di_f/dt

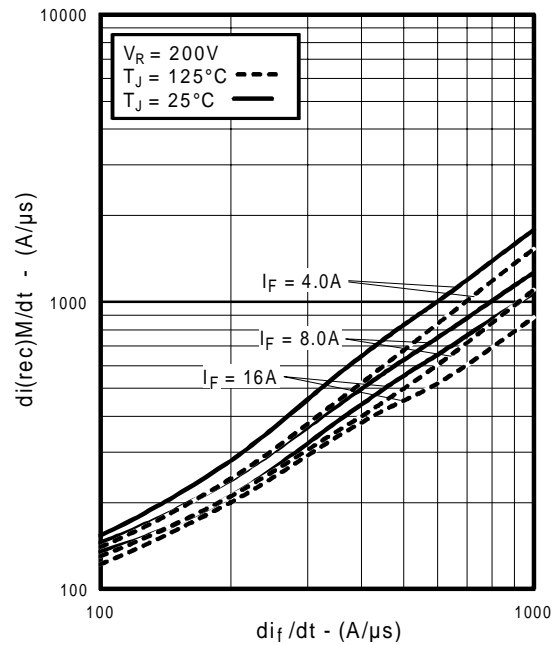

Fig. 17 - Typical $di_{(rec)M}/dt$ vs. di_f/dt

IRG4BC20MD

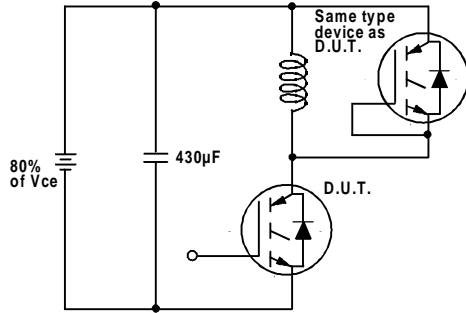

Fig. 18a - Test Circuit for Measurement of I_{LM} , E_{on} , $E_{off}(\text{diode})$, t_{rr} , Q_{rr} , I_{rr} , $t_{d(on)}$, t_r , $t_{d(off)}$, t_f

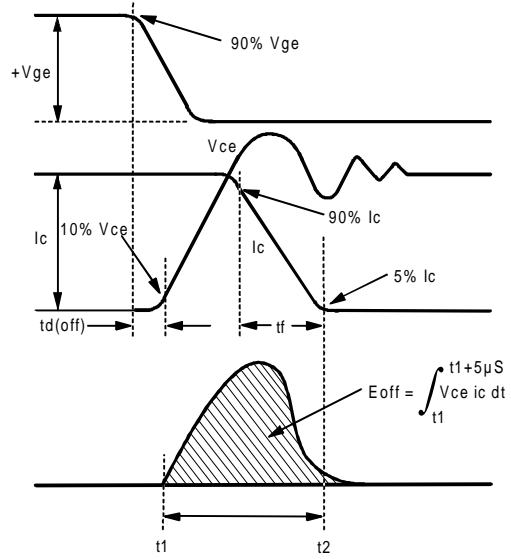

Fig. 18b - Test Waveforms for Circuit of Fig. 18a, Defining E_{off} , $t_{d(off)}$, t_f

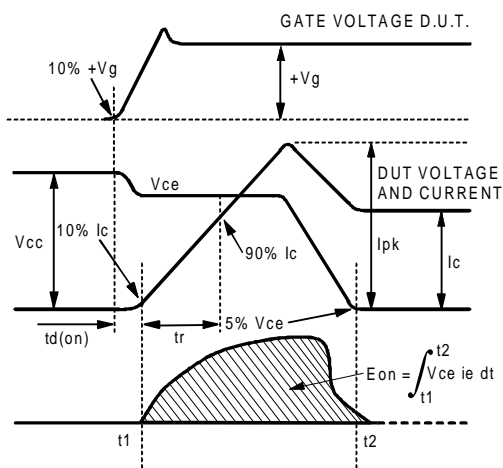

Fig. 18c - Test Waveforms for Circuit of Fig. 18a, Defining E_{on} , $t_{d(on)}$, t_r

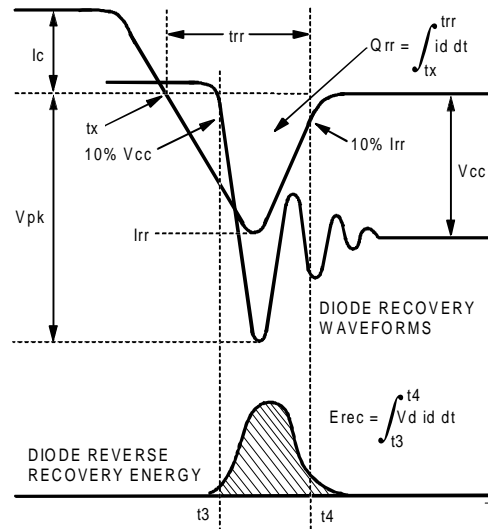

Fig. 18d - Test Waveforms for Circuit of Fig. 18a, Defining E_{rec} , t_{rr} , Q_{rr} , I_{rr}

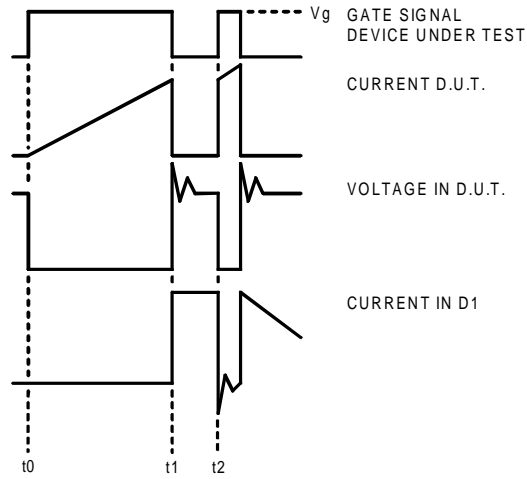

Figure 18e. Macro Waveforms for Figure 18a's Test Circuit

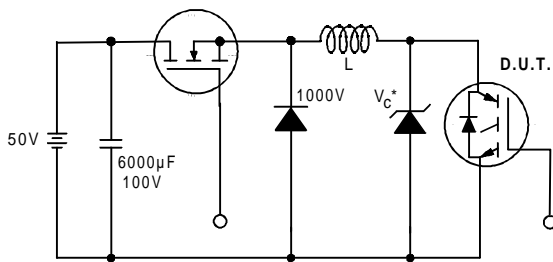

Figure 19. Clamped Inductive Load Test Circuit

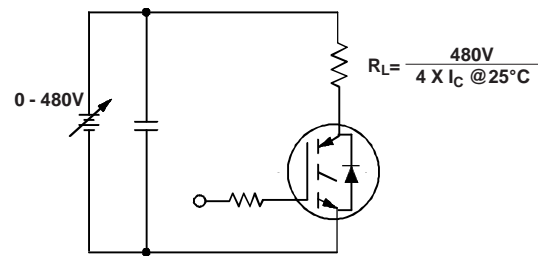

Figure 20. Pulsed Collector Current Test Circuit

IRG4BC20MD

Notes:

- ① Repetitive rating: $V_{GE}=20V$; pulse width limited by maximum junction temperature (figure 20)
- ② $V_{CC}=80\%(V_{CES})$, $V_{GE}=20V$, $L=10\mu H$, $R_G = 50\Omega$ (figure 19)
- ③ Pulse width $\leq 80\mu s$; duty factor $\leq 0.1\%$.
- ④ Pulse width $5.0\mu s$, single shot.

Case Outline — TO-220AB

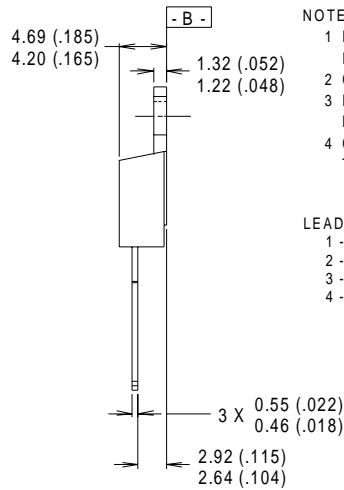
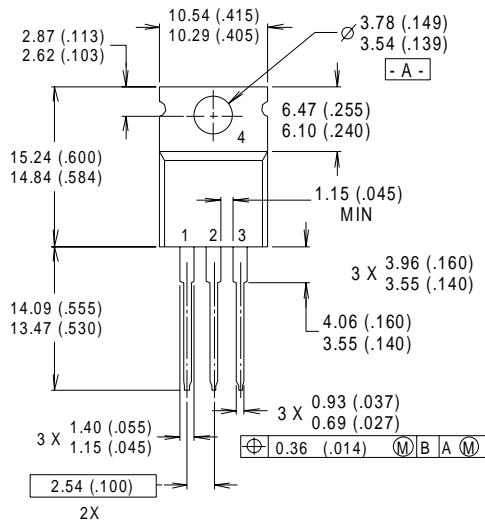

NOTES:

- 1 DIMENSIONS & TOLERANCING PER ANSI Y14.5M, 1982.
- 2 CONTROLLING DIMENSION : INCH.
- 3 DIMENSIONS ARE SHOWN MILLIMETERS (INCHES).
- 4 CONFORMS TO JEDEC OUTLINE TO-220AB.

LEAD ASSIGNMENTS

- 1 - GATE
- 2 - COLLECTOR
- 3 - EMITTER
- 4 - COLLECTOR

CONFORMS TO JEDEC OUTLINE TO-220AB

Dimensions in Millimeters and (Inches)

Data and specifications subject to change without notice.
This product has been designed and qualified for the Industrial market.
Qualification Standards can be found on IR's Web site.