

High Voltage IGBT with optional Diode

Short Circuit SOA Capability
Square RBSOA

IXDH 30N120
IXDH 30N120 D1
IXDT 30N120
IXDT 30N120 D1

$V_{CES} = 1200\text{ V}$
 $I_{C25} = 60\text{ A}$
 $V_{CE(sat) typ} = 2.4\text{ V}$

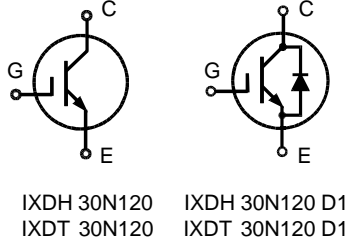

TO-247 AD (IXDH)

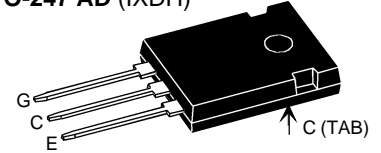

TO-268 AA (IXDT)

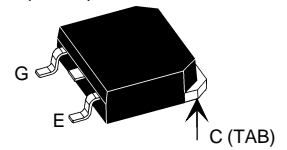

G = Gate,
C = Collector ,

E = Emitter
TAB = Collector

Symbol	Conditions	Maximum Ratings	
V_{CES}	$T_J = 25^\circ\text{C}$ to 150°C	1200	V
V_{CGR}	$T_J = 25^\circ\text{C}$ to 150°C ; $R_{GE} = 20\text{ k}\Omega$	1200	V
V_{GES}	Continuous	± 20	V
V_{GEM}	Transient	± 30	V
I_{C25}	$T_C = 25^\circ\text{C}$	60	A
I_{C90}	$T_C = 90^\circ\text{C}$	38	A
I_{CM}	$T_C = 90^\circ\text{C}$, $t_p = 1\text{ ms}$	76	A
RBSOA	$V_{GE} = \pm 15\text{ V}$, $T_J = 125^\circ\text{C}$, $R_G = 47\ \Omega$ Clamped inductive load, $L = 30\ \mu\text{H}$	$I_{CM} = 50$ $V_{CEK} < V_{CES}$	A
t_{SC} (SCSOA)	$V_{GE} = \pm 15\text{ V}$, $V_{CE} = V_{CES}$, $T_J = 125^\circ\text{C}$ $R_G = 47\ \Omega$, non repetitive	10	μs
P_C	$T_C = 25^\circ\text{C}$	IGBT Diode	300 135 W W
T_J		-55 ... +150	$^\circ\text{C}$
T_{stg}		-55 ... +150	$^\circ\text{C}$
	Maximum lead temperature for soldering 1.6 mm (0.062 in.) from case for 10 s	300	$^\circ\text{C}$
M_d	Mounting torque	1.1/10	Nm/lb.in.
Weight		6	g

Features

- NPT IGBT technology
- low saturation voltage
- low switching losses
- square RBSOA, no latch up
- high short circuit capability
- positive temperature coefficient for easy paralleling
- MOS input, voltage controlled
- optional ultra fast diode
- International standard packages

Advantages

- Space savings
- High power density
- IXDT:
surface mountable high power package

Typical Applications

- AC motor speed control
- DC servo and robot drives
- DC choppers
- Uninterruptible power supplies (UPS)
- Switch-mode and resonant-mode power supplies

Symbol	Conditions	Characteristic Values ($T_J = 25^\circ\text{C}$, unless otherwise specified)		
		min.	typ.	max.
$V_{(BR)CES}$	$V_{GE} = 0\text{ V}$	1200		V
$V_{GE(th)}$	$I_C = 1\text{ mA}$, $V_{CE} = V_{GE}$	4.5		6.5 V
I_{CES}	$V_{CE} = V_{CES}$		$T_J = 25^\circ\text{C}$ $T_J = 125^\circ\text{C}$	1.5 mA mA
I_{GES}	$V_{CE} = 0\text{ V}$, $V_{GE} = \pm 20\text{ V}$			$\pm 500\text{ nA}$
$V_{CE(sat)}$	$I_C = 30\text{ A}$, $V_{GE} = 15\text{ V}$	2.4	2.9	V

Symbol	Conditions	Characteristic Values		
		(T _J = 25°C, unless otherwise specified)		
		min.	typ.	max.
C _{ies}	V _{CE} = 25 V, V _{GE} = 0 V, f = 1 MHz		1650	pF
C _{oes}			250	pF
C _{res}			110	pF
Q _g	I _C = 30 A, V _{GE} = 15 V, V _{CE} = 0.5 V _{CES}		120	nC
t _{d(on)}	Inductive load, T _J = 125°C I _C = 30 A, V _{GE} = ±15 V, V _{CE} = 600 V, R _G = 47 Ω		100	ns
t _r			70	ns
t _{d(off)}			500	ns
t _f			70	ns
E _{on}			4.6	mJ
E _{off}		3.4	mJ	
R _{thJC}				0.42 K/W
R _{thCK}	Package with heatsink compound		0.25	K/W

TO-247 AD Outline

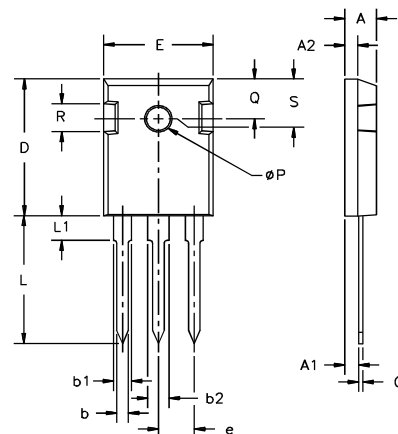

Dim.	Millimeter		Inches	
	Min.	Max.	Min.	Max.
A	4.7	5.3	.185	.209
A ₁	2.2	2.54	.087	.102
A ₂	2.2	2.6	.059	.098
b	1.0	1.4	.040	.055
b ₁	1.65	2.13	.065	.084
b ₂	2.87	3.12	.113	.123
C	.4	.8	.016	.031
D	20.80	21.46	.819	.845
E	15.75	16.26	.610	.640
e	5.20	5.72	0.205	0.225
L	19.81	20.32	.780	.800
L1		4.50		.177
∅P	3.55	3.65	.140	.144
Q	5.89	6.40	0.232	0.252
R	4.32	5.49	.170	.216
S	6.15	BSC	.242	BSC

Reverse Diode (FRED) [D1 version only]

Characteristic Values
(T_J = 25°C, unless otherwise specified)

Symbol	Conditions	Characteristic Values		
		min.	typ.	max.
V _F	I _F = 30 A, V _{GE} = 0 V	2.5	2.7	V
	I _F = 30 A, V _{GE} = 0 V, T _J = 125°C	2.0		V
I _F	T _C = 25°C		60	A
	T _C = 90°C		35	A
I _{RM}	I _F = 30 A, -di _F /dt = 400 A/μs, V _R = 600 V	20		A
t _{rr}	V _{GE} = 0 V, T _J = 125°C	200		ns
t _{rr}	I _F = 1 A, -di _F /dt = 100 A/μs, V _R = 30 V, V _{GE} = 0 V	40		ns
R _{thJC}				1 K/W

TO-268 AA Outline

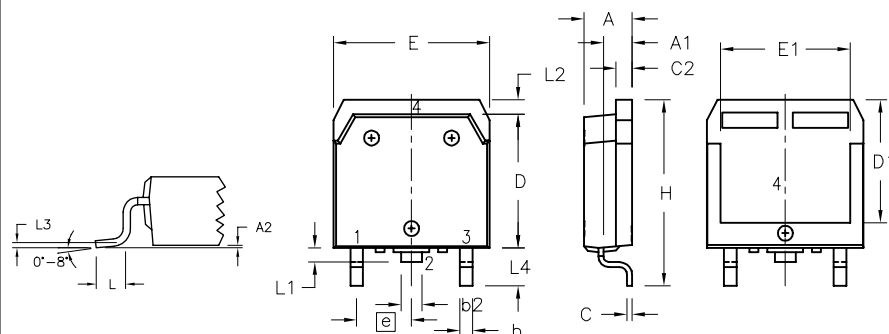

Dim.	Millimeter		Inches	
	Min.	Max.	Min.	Max.
A	4.9	5.1	.193	.201
A ₁	2.7	2.9	.106	.114
A ₂	.02	.25	.001	.010
b	1.15	1.45	.045	.057
b ₂	1.9	2.1	.075	.083
C	.4	.65	.016	.026
D	13.80	14.00	.543	.551
E	15.85	16.05	.624	.632
E ₁	13.3	13.6	.524	.535
e	5.45	BSC	.215	BSC
H	18.70	19.10	.736	.752
L	2.40	2.70	.094	.106
L1	1.20	1.40	.047	.055
L2	1.00	1.15	.039	.045
L3		0.25	BSC	.010
L4	3.80	4.10	.150	.161

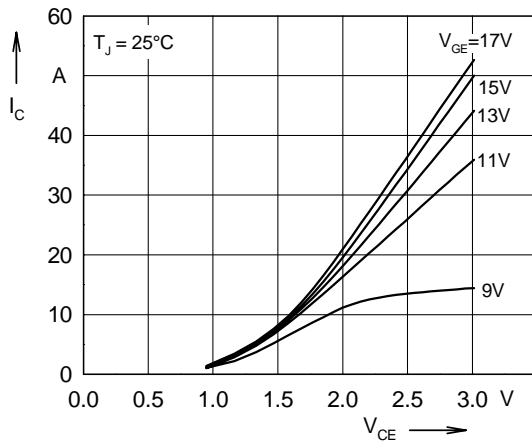

Fig. 1 Typ. output characteristics

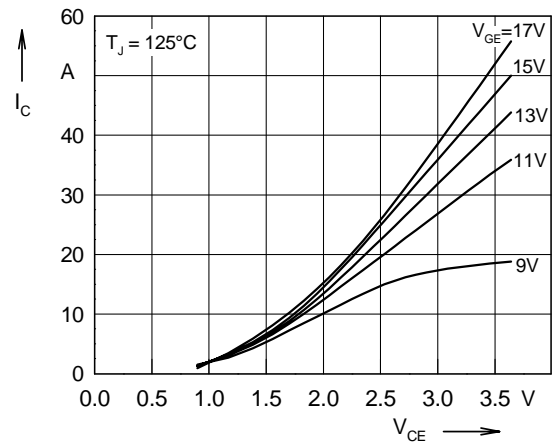

Fig. 2 Typ. output characteristics

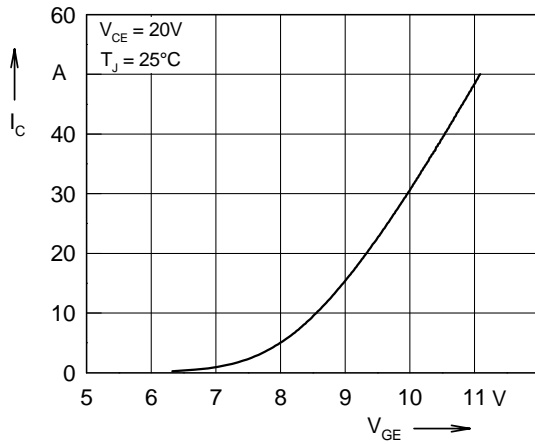

Fig. 3 Typ. transfer characteristics

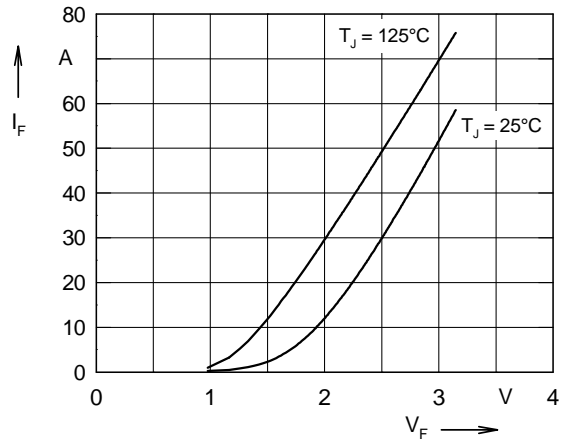

Fig. 4 Typ. forward characteristics of free wheeling diode

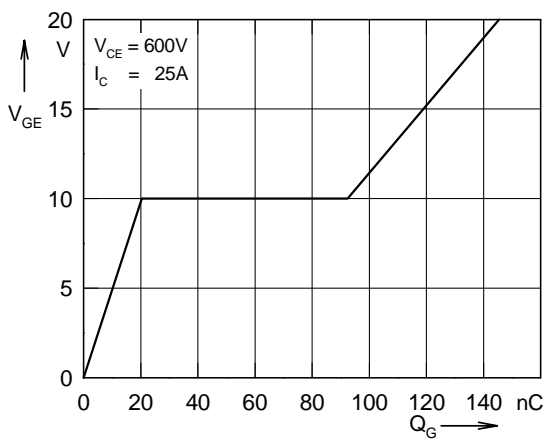

Fig. 5 Typ. turn on gate charge

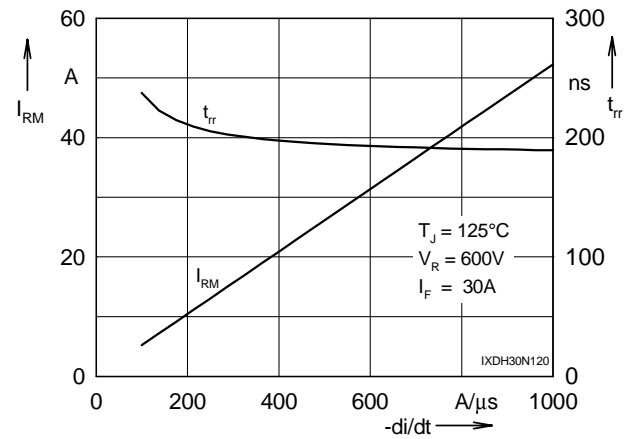

Fig. 6 Typ. turn off characteristics of free wheeling diode

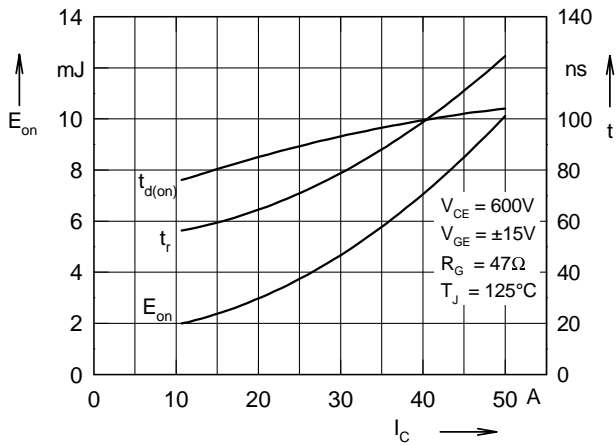

Fig. 7 Typ. turn on energy and switching times versus collector current

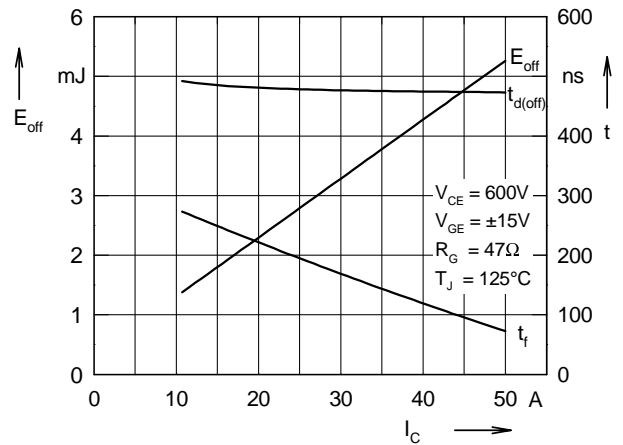

Fig. 8 Typ. turn off energy and switching times versus collector current

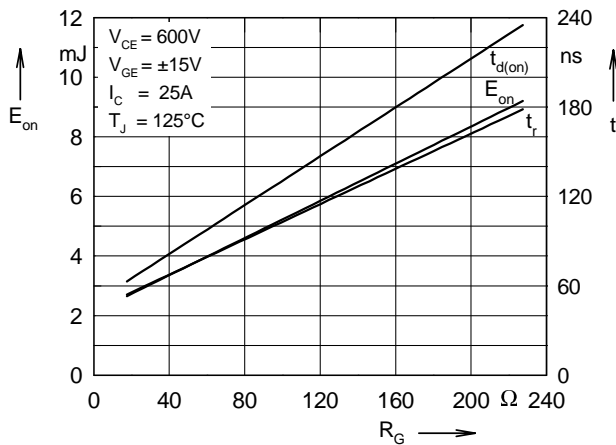

Fig. 9 Typ. turn on energy and switching times versus gate resistor

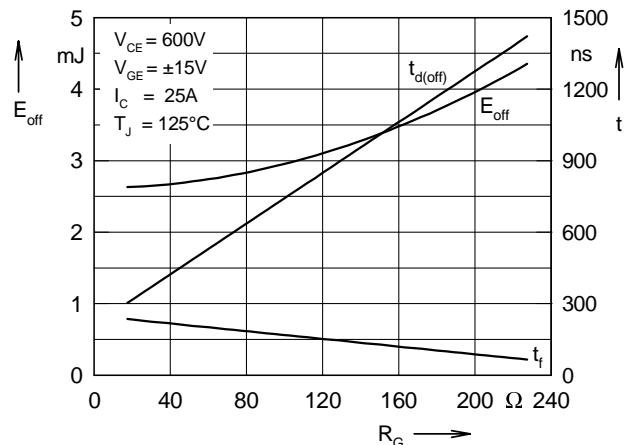

Fig. 10 Typ. turn off energy and switching times versus gate resistor

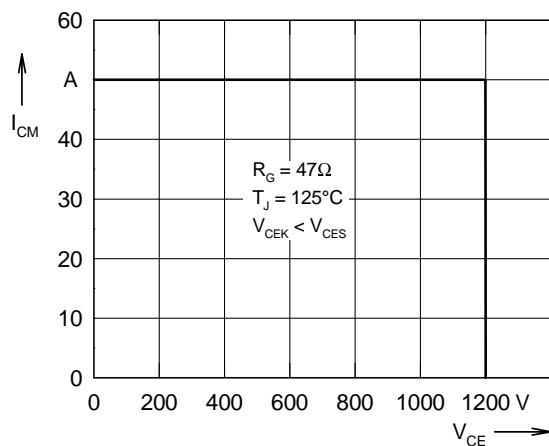

Fig. 11 Reverse biased safe operating area RBSOA

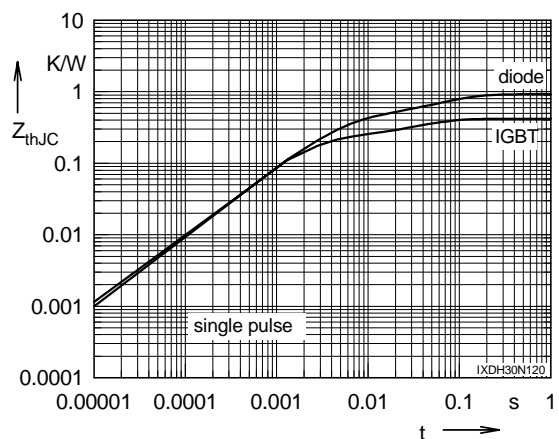

Fig. 12 Typ. transient thermal impedance