

## FEATURES

- Very Low Power:  $I_{CC} = 110\mu\text{A Typ}$
- Designed for RS485 or RS422 Applications
- Single 5V Supply
- -7V to 12V Bus Common-Mode Range Permits  $\pm 7\text{V GND}$  Difference Between Devices on the Bus
- Thermal Shutdown Protection
- Power-Up/Down Glitch-Free Driver Outputs Permit Live Insertion/Removal of Package
- Driver Maintains High Impedance in Three-State or with the Power Off
- 28ns Typical Driver Propagation Delays with 5ns Skew
- Pin Compatible with the SN75174, DS96174,  $\mu\text{A96174}$ , and DS96F174

## APPLICATIONS

- Low Power RS485/RS422 Drivers
- Level Translator

## DESCRIPTION

The LTC487<sup>®</sup> is a low power differential bus/line driver designed for multipoint data transmission standard RS485 applications with extended common-mode range (-7V to 12V). It also meets RS422 requirements.

The CMOS design offers significant power savings over its bipolar counterpart without sacrificing ruggedness against overload or ESD damage.

The driver features three-state outputs, with the driver outputs maintaining high impedance over the entire common-mode range. Excessive power dissipation caused by bus contention or faults is prevented by a thermal shutdown circuit which forces the driver outputs into a high impedance state.

Both AC and DC specifications are guaranteed from 0°C to 70°C (Commercial), -40°C to 85°C (Industrial) and over the 4.75V to 5.25V supply voltage range.

 and LTC are registered trademarks and LT is a trademark of Linear Technology Corporation.

## TYPICAL APPLICATION

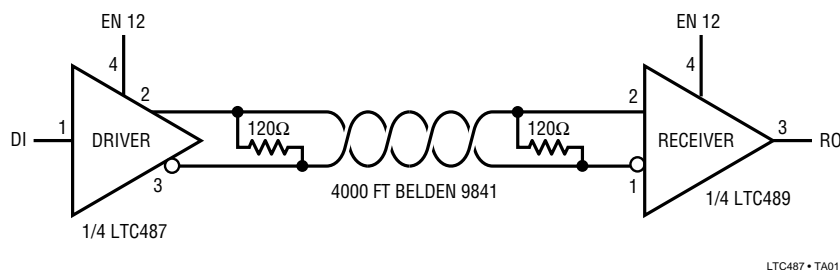

RS485 Cable Length Specification\*

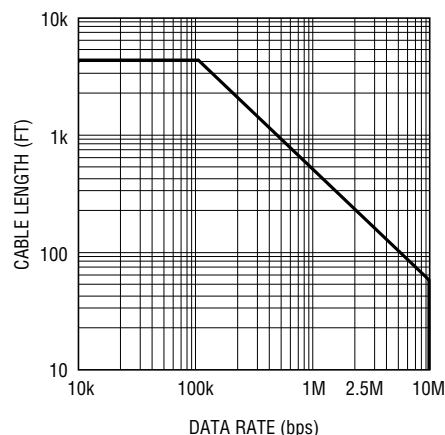

\* APPLIES FOR 24 GAUGE, POLYETHYLENE DIELECTRIC TWISTED PAIR

## ABSOLUTE MAXIMUM RATINGS

(Note 1)

Supply Voltage ( $V_{CC}$ ) .....	12V
Control Input Voltages .....	-0.5V to $V_{CC} + 0.5V$
Driver Input Voltages .....	-0.5V to $V_{CC} + 0.5V$
Driver Output Voltages .....	$\pm 14V$
Control Input Currents .....	$\pm 25mA$
Driver Input Currents .....	$\pm 25mA$
Operating Temperature Range	
Commercial .....	0°C to 70°C
Industrial .....	-40°C to 85°C
Storage Temperature Range .....	-65°C to 150°C
Lead Temperature (Soldering, 10 sec.) .....	300°C

## PACKAGE/ORDER INFORMATION

N PACKAGE  
16-LEAD PLASTIC DIP

S PACKAGE  
16-LEAD PLASTIC SOL

$T_{JMAX} = 125^{\circ}C, \theta_{JA} = 70^{\circ}C/W (N)$   
 $T_{JMAX} = 150^{\circ}C, \theta_{JA} = 95^{\circ}C/W (S)$

ORDER PART NUMBER

LTC487CN  
LTC487CS  
LTC487IN  
LTC487IS

Consult factory for Military grade parts.

## DC ELECTRICAL CHARACTERISTICS

$V_{CC} = 5V \pm 5\%$ ,  $0^{\circ}C \leq T_A \leq 70^{\circ}C$  (Commercial),  $-40^{\circ}C \leq T_A \leq 85^{\circ}C$  (Industrial) (Note 2, 3)

SYMBOL	PARAMETER	CONDITIONS	MIN	TYP	MAX	UNITS
$V_{OD1}$	Differential Driver Output Voltage (Unloaded)	$I_O = 0$			5	V
$V_{OD2}$	Differential Driver Output Voltage (With Load)	$R = 50\Omega$ ; (RS422)	2			V
		$R = 27\Omega$ ; (RS485) (Figure 3)	1.5		5	V
$V_{OD}$	Change in Magnitude of Driver Differential Output Voltage for Complementary Output States	$R = 27\Omega$ or $R = 50\Omega$ (Figure 3)			0.2	V
$V_{OC}$	Driver Common-Mode Output Voltage				3	V
$ V_{OC} $	Change in Magnitude of Driver Common-Mode Output Voltage for Complementary Output States				0.2	V
$V_{IH}$	Input High Voltage	DI, EN12, EN34	2.0		V	
$V_{IL}$	Input Low Voltage				0.8	V
$I_{IN1}$	Input Current				$\pm 2$	$\mu A$
$I_{CC}$	Supply Current	No Load		110	200	$\mu A$
		Output Enabled		110	200	$\mu A$
$I_{OSD1}$	Driver Short-Circuit Current, $V_{OUT} = \text{High}$	$V_O = -7V$		100	250	mA
$I_{OSD2}$	Driver Short-Circuit Current, $V_{OUT} = \text{Low}$	$V_O = 12V$		100	250	mA
$I_{OZ}$	High Impedance State Output Current	$V_O = -7V$ to $12V$		$\pm 10$	$\pm 200$	$\mu A$

## SWITCHING CHARACTERISTICS $V_{CC} = 5V \pm 5\%$ , $0^{\circ}C \leq T_A \leq 70^{\circ}C$ (Note 2, 3)

SYMBOL	PARAMETER	CONDITIONS	MIN	TYP	MAX	UNITS
$t_{PLH}$	Driver Input to Output	$R_{DIFF} = 54\Omega, C_{L1} = C_{L2} = 100pF$ (Figures 1, 4)	10	30	50	ns
$t_{PHL}$	Driver Input to Output		10	30	50	ns
$t_{SKEW}$	Driver Output to Output			5	15	ns
$t_r, t_f$	Driver Rise or Fall Time		5	20	25	ns
$t_{ZH}$	Driver Enable to Output High	$C_L = 100pF$ (Figures 2, 5) S2 Closed		35	70	ns
$t_{ZL}$	Driver Enable to Output Low	$C_L = 100pF$ (Figures 2, 5) S1 Closed		35	70	ns
$t_{LZ}$	Driver Disable Time from Low	$C_L = 15pF$ (Figures 2, 5) S1 Closed		35	70	ns
$t_{HZ}$	Driver Disable Time from High	$C_L = 15pF$ (Figures 2, 5) S2 Closed		35	70	ns

**Note 1:** Absolute maximum ratings are those beyond which the safety of the device cannot be guaranteed.

**Note 2:** All currents into device pins are positive; all currents out of device

pins are negative. All voltages are referenced to device GND unless otherwise specified.

**Note 3:** All typicals are given for  $V_{CC} = 5V$  and Temperature = 25°C.

# TYPICAL PERFORMANCE CHARACTERISTICS

**Driver Output High Voltage vs Output Current**

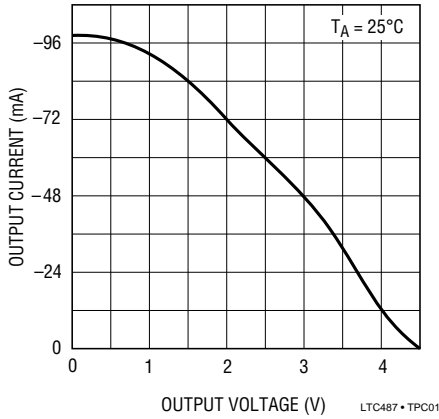

**Driver Differential Output Voltage vs Output Current**

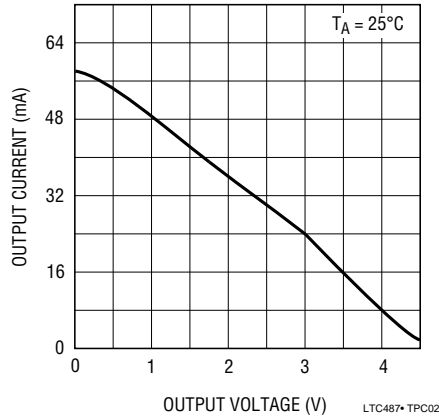

**Driver Output Low Voltage vs Output Current**

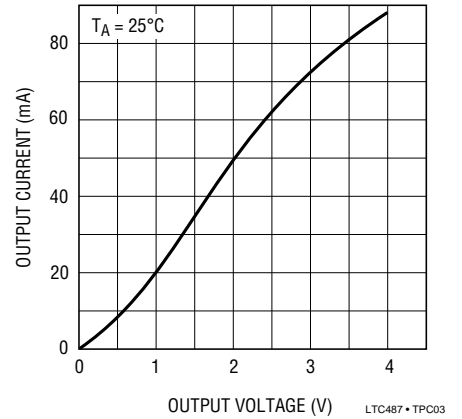

**TTL Input Threshold vs Temperature**

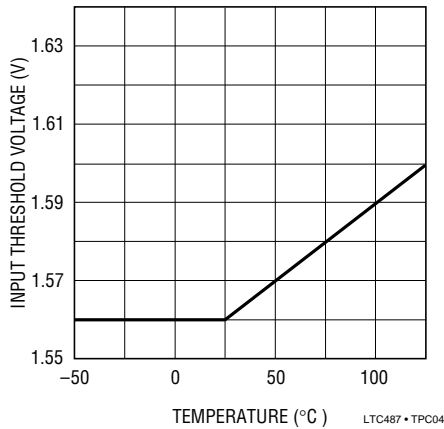

**Driver Skew vs Temperature**

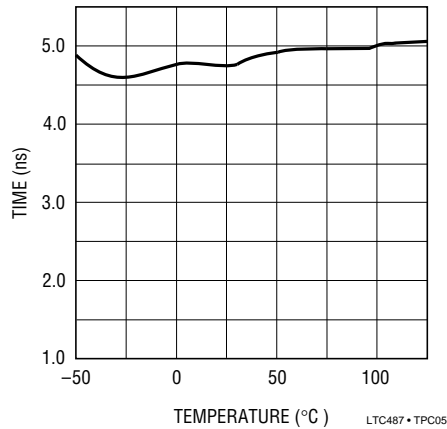

**Supply Current vs Temperature**

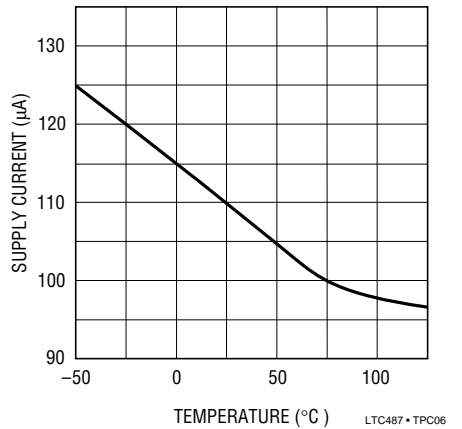

**Driver Differential Output Voltage vs Temperature**

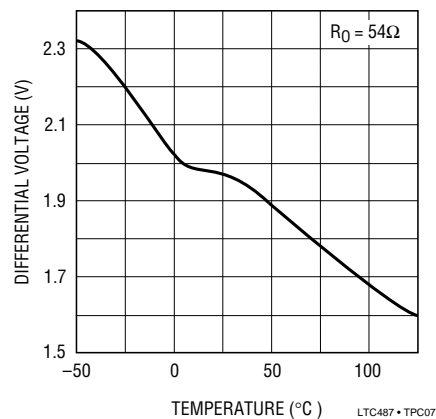

## PIN FUNCTIONS

**D11 (Pin 1):** Driver 1 input. If Driver 1 is enabled, then a low on D11 forces the driver outputs DO1A low and DO1B high. A high on D11 with the driver outputs enabled will force DO1A high and DO1B low.

**DO1A (Pin 2):** Driver 1 output.

**DO1B (Pin 3):** Driver 1 output.

**EN12 (Pin 4):** Driver 1 and 2 outputs enabled. See Function Table for details.

**DO2B (Pin 5):** Driver 2 output.

**DO2A (Pin 6):** Driver 2 output.

**D12 (Pin 7):** Driver 2 input. Refer to D11.

**GND (Pin 8):** GND connection.

**D13 (Pin 9):** Driver 3 input. Refer to D11.

**DO3A (Pin 10):** Driver 3 output.

**DO3B (Pin 11):** Driver 3 output.

**EN34 (Pin 12):** Driver 3 and 4 outputs enabled. See Function Table for details.

**DO4B (Pin 13):** Driver 4 output.

**DO4A (Pin 14):** Driver 4 output.

**D14 (Pin 15):** Driver 4 input. Refer to D11.

**V<sub>CC</sub> (Pin 16):** Positive supply;  $4.75 < V_{CC} < 5.25$ .

## FUNCTION TABLE

INPUT	ENABLES	OUTPUTS	
DI	EN12 or EN34	OUT A	OUT B
H	H	H	L
L	H	L	H
X	L	Z	Z

H: High Level  
 L: Low Level  
 X: Irrelevant  
 Z: High Impedance (Off)

## SWITCHING TIME WAVEFORMS

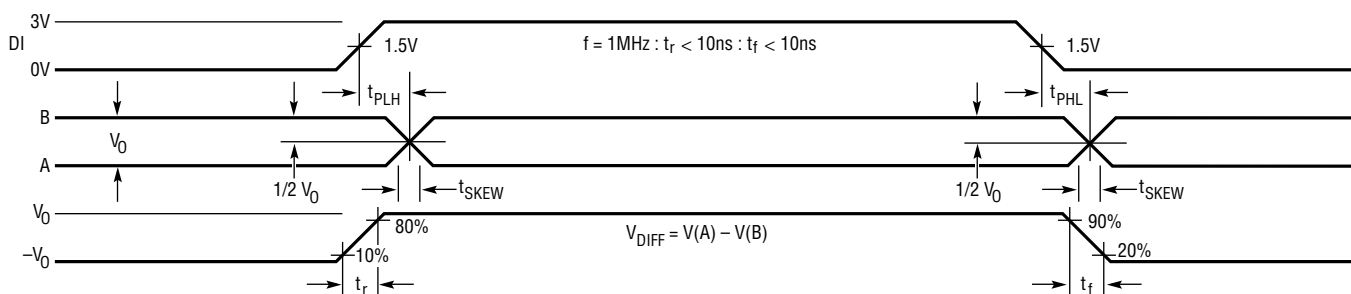

Figure 1. Driver Propagation Delays

LTC487 • TA05

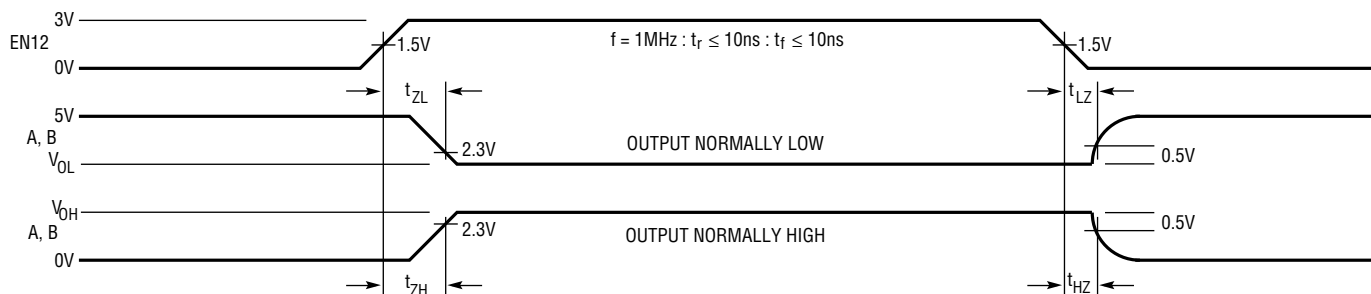
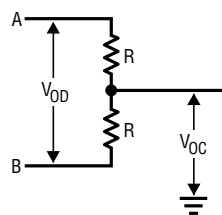

Figure 2. Driver Enable and Disable Times

LTC487 • TA06

## TEST CIRCUITS



LTC487 • TA02

Figure 3. Driver DC Test Load

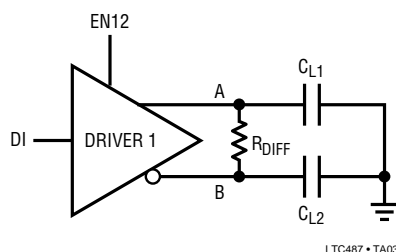

LTC487 • TA03

Figure 4. Driver Timing Test Circuit

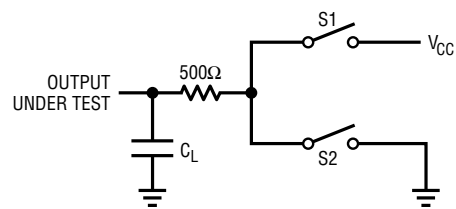

LTC487 • TA04

Figure 5. Driver Timing Test Load #2

## APPLICATIONS INFORMATION

### Typical Application

A typical connection of the LTC487 is shown in Figure 6. A twisted pair of wires connect up to 32 drivers and receivers for half duplex data transmission. There are no restrictions on where the chips are connected to the wires, and it isn't necessary to have the chips connected at the ends. However, the wires must be terminated only at the ends with a resistor equal to their characteristic impedance, typically 120Ω. The optional shields around the twisted pair help reduce unwanted noise, and are connected to GND at one end.

### Thermal Shutdown

The LTC487 has a thermal shutdown feature which protects the part from excessive power dissipation. If the outputs of the driver are accidentally shorted to a power supply or low impedance source, up to 250mA can flow

through the part. The thermal shutdown circuit disables the driver outputs when the internal temperature reaches 150°C and turns them back on when the temperature cools to 130°C. If the outputs of two or more LTC487 drivers are shorted directly, the driver outputs can not supply enough current to activate the thermal shutdown. Thus, the thermal shutdown circuit will not prevent contention faults when two drivers are active on the bus at the same time.

### Cable and Data Rate

The transmission line of choice for RS485 applications is a twisted pair. There are coaxial cables (twinaxial) made for this purpose that contain straight pairs, but these are less flexible, more bulky, and more costly than twisted pairs. Many cable manufacturers offer a broad range of 120Ω cables designed for RS485 applications.

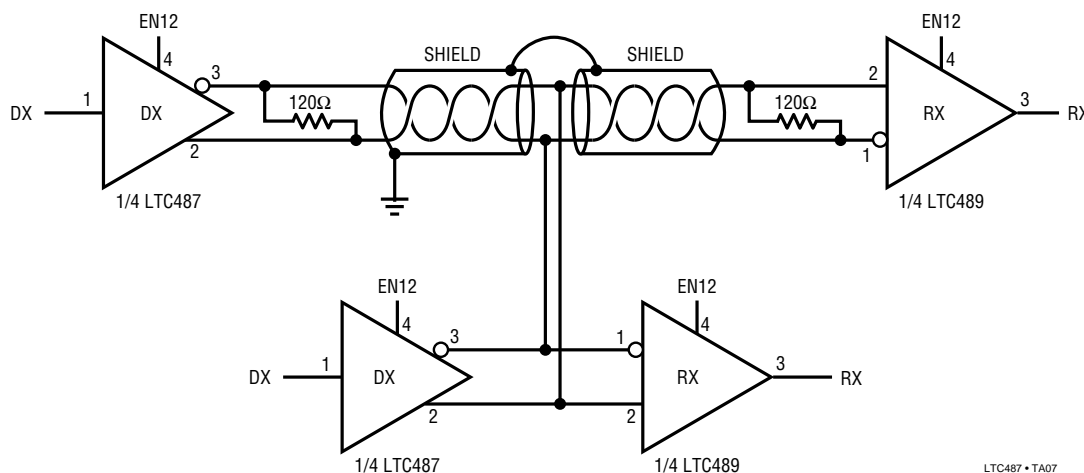

LTC487 • TA07

Figure 6. Typical Connection

## APPLICATIONS INFORMATION

Losses in a transmission line are a complex combination of DC conductor loss, AC losses (skin effect), leakage, and AC losses in the dielectric. In good polyethylene cables such as the Belden 9841, the conductor losses and dielectric losses are of the same order of magnitude, leading to relatively low overall loss (Figure 7).

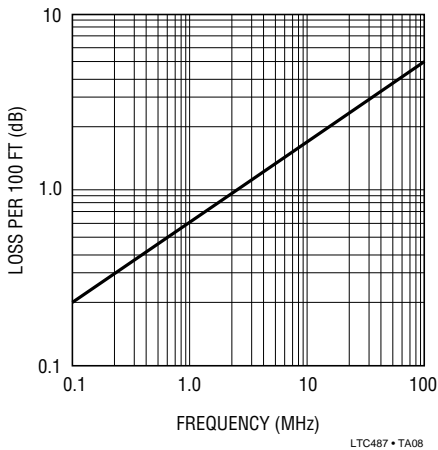

Figure 7. Attenuation vs Frequency for Belden 9841

When using low loss cables, Figure 8 can be used as a guideline for choosing the maximum line length for a given data rate. With lower quality PVC cables, the dielectric loss factor can be 1000 times worse. PVC twisted pairs have terrible losses at high data rates (> 100kbs) and greatly reduce the maximum cable length. At low data rates however, they are acceptable and much more economical.

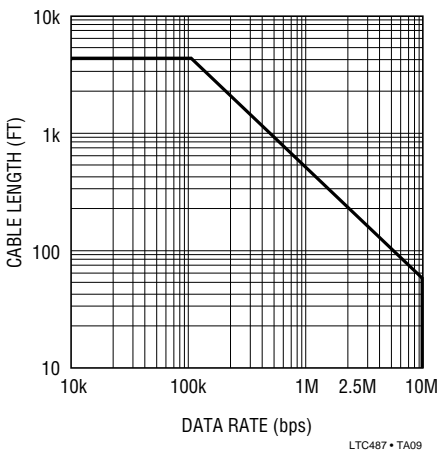

Figure 8. Cable Length vs Data Rate

### Cable Termination

The proper termination of the cable is very important. If the cable is not terminated with its characteristic impedance, distorted waveforms will result. In severe cases, distorted (false) data and nulls will occur. A quick look at the output of the driver will tell how well the cable is terminated. It is best to look at a driver connected to the end of the cable, since this eliminates the possibility of getting reflections from two directions. Simply look at the driver output while transmitting square wave data. If the cable is terminated properly, the waveform will look like a square wave (Figure 9).

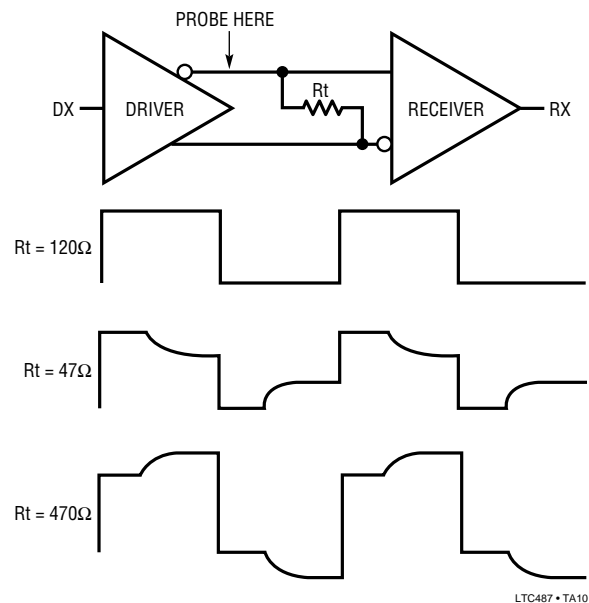

Figure 9. Termination Effects

If the cable is loaded excessively ( $47\Omega$ ), the signal initially sees the surge impedance of the cable and jumps to an initial amplitude. The signal travels down the cable and is reflected back out of phase because of the mistermiation. When the reflected signal returns to the driver, the amplitude will be lowered. The width of the pedestal is equal to twice the electrical length of the cable (about 1.5ns/foot). If the cable is lightly loaded ( $470\Omega$ ), the signal reflects in phase and increases the amplitude at the driver output. An input frequency of 30kHz is adequate for tests out to 4000 feet of cable.

## APPLICATIONS INFORMATION

### AC Cable Termination

Cable termination resistors are necessary to prevent unwanted reflections, but they consume power. The typical differential output voltage of the driver is 2V when the cable is terminated with two 120Ω resistors, causing 33mA of DC current to flow in the cable when no data is being sent. This DC current is about 220 times greater than the supply current of the LTC487. One way to eliminate the unwanted current is by AC coupling the termination resistors as shown in Figure 10.

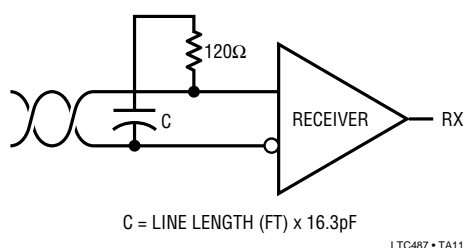

**Figure 10. AC Coupled Termination**

The coupling capacitor must allow high-frequency energy to flow to the termination, but block DC and low frequencies. The dividing line between high and low frequency depends on the length of the cable. The coupling capacitor must pass frequencies above the point where the line represents an electrical one-tenth wavelength. The value of the coupling capacitor should therefore be set at 16.3pF per foot of cable length for 120Ω cables. With the coupling capacitors in place, power is consumed only on the signal edges, and not when the driver output is idling at a 1 or 0 state. A 100nF capacitor is adequate for lines up to 4000 feet in length. Be aware that the power savings start to decrease once the data rate surpasses  $1/(120\Omega \times C)$ .

### Receiver Open-Circuit Fail-Safe

Some data encoding schemes require that the output of the receiver maintains a known state (usually a logic 1) when the data is finished transmitting and all drivers on the line are forced into three-state. All LTC RS485 receivers have a fail-safe feature which guarantees the output to be in a logic 1 state when the receiver inputs are left floating (open-circuit). However, when the cable is terminated with 120Ω, the differential inputs to the receiver are shorted together, not left floating. Because the receiver

has about 70mV of hysteresis, the receiver output will maintain the last data bit received.

If the receiver output must be forced to a known state, the circuits of Figure 11 can be used.

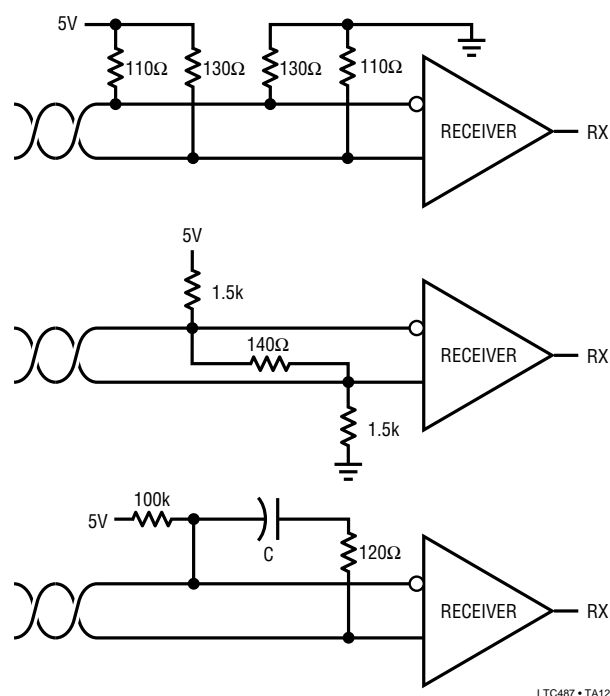

**Figure 11. Forcing '0' When All Drivers Are Off**

The termination resistors are used to generate a DC bias which forces the receiver output to a known state, in this case a logic 0. The first method consumes about 208mW and the second about 8mW. The lowest power solution is to use an AC termination with a pull-up resistor. Simply swap the receiver inputs for data protocols ending in logic 1.

### Fault Protection

All of LTC's RS485 products are protected against ESD transients up to 2kV using the human body model (100pF, 1.5kΩ). However, some applications need more protection. The best protection method is to connect a bidirectional TransZorb<sup>®</sup> from each line side pin to ground (Figure 12).

TransZorb is a registered trademark of General Instruments, GSI

## APPLICATIONS INFORMATION

A TransZorb is a silicon transient voltage suppressor that has exceptional surge handling capabilities, fast response time, and low series resistance. They are available from General Semiconductor Industries and come in a variety of breakdown voltages and prices. Be sure to pick a breakdown voltage higher than the common-mode voltage required for your application (typically 12V). Also, don't forget to check how much the added parasitic capacitance will load down the bus.

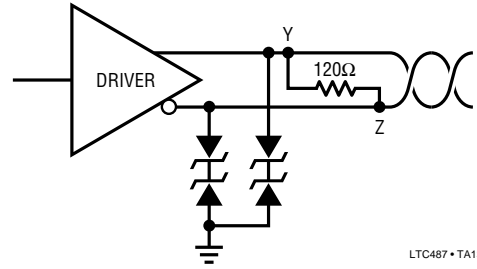

LTC487 • TA13

Figure 12. ESD Protection with TransZorbs

## TYPICAL APPLICATION

### RS232 to RS485 Level Translator with Hysteresis

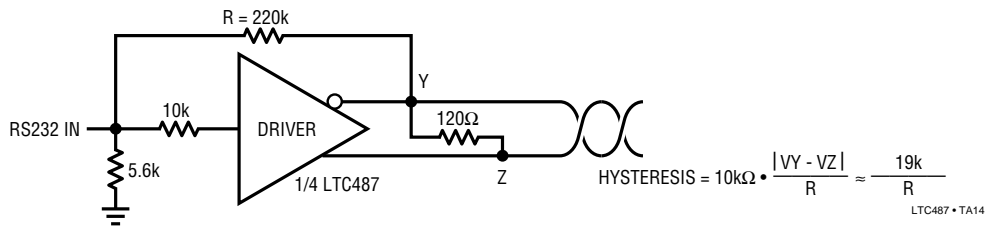

LTC487 • TA14

## PACKAGE DESCRIPTION

Dimensions in inches (millimeters) unless otherwise noted.

### N Package, 16-Lead Plastic DIP

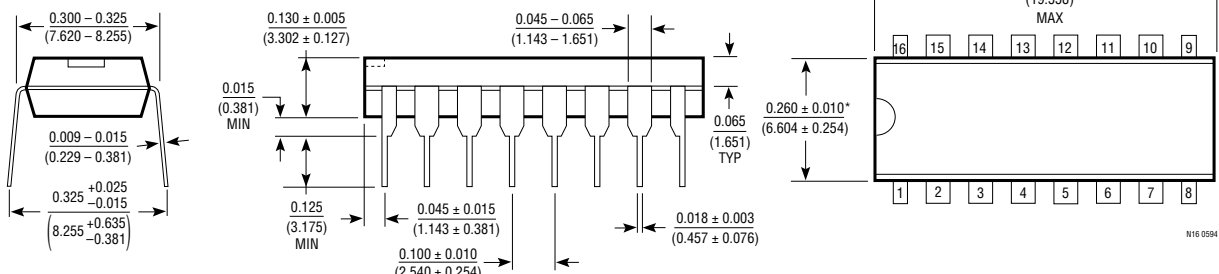

\*THESE DIMENSIONS DO NOT INCLUDE MOLD FLASH OR PROTRUSIONS. MOLD FLASH OR PROTRUSIONS SHALL NOT EXCEED 0.010 INCH (0.254mm).

### S Package, 16-Lead Plastic SOL

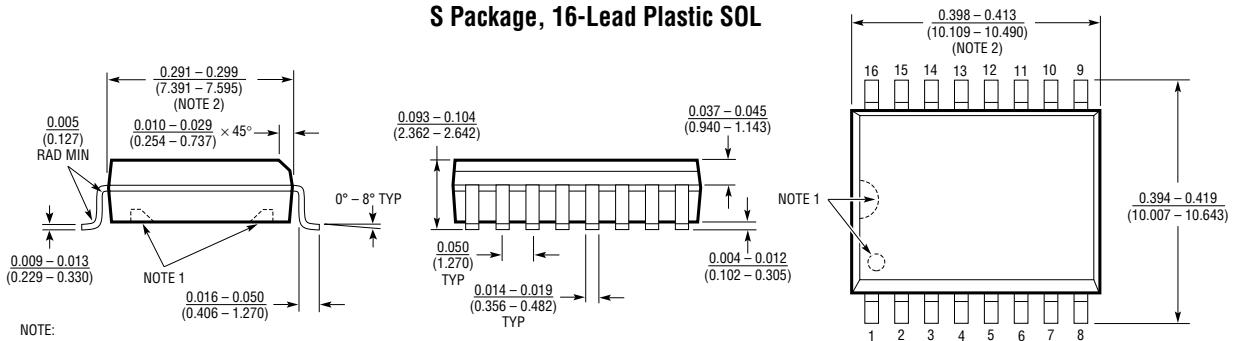

NOTE:  
 1. PIN 1 IDENT, NOTCH ON TOP AND CAVITIES ON THE BOTTOM OF PACKAGES ARE THE MANUFACTURING OPTIONS. THE PART MAY BE SUPPLIED WITH OR WITHOUT ANY OF THE OPTIONS.  
 2. THESE DIMENSIONS DO NOT INCLUDE MOLD FLASH OR PROTRUSIONS. MOLD FLASH OR PROTRUSIONS SHALL NOT EXCEED 0.006 INCH (0.15mm).