

Combinatorial PAL10H8 Series

**10H8, 12H6, 14H4, 16H2
 16C1
 10L8, 12L6, 14L4, 16L2**

Features/Benefits

- Combinatorial architectures
- Active high or active low options
- Security fuse

Ordering Information

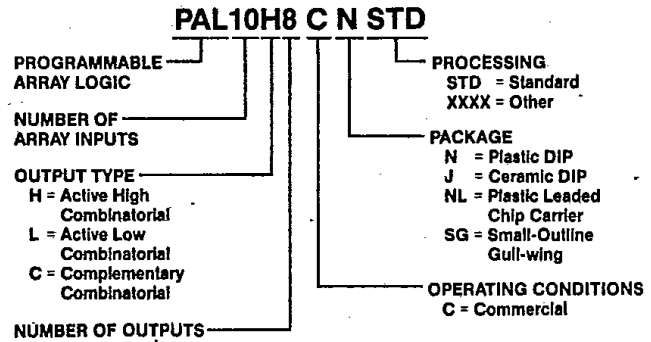

	INPUTS	OUTPUTS	POLARITY	t _{PD} (ns)	I _{CC} (mA)
PAL10H8	10	8	HIGH	35	90
PAL12H6	12	6	HIGH	35	90
PAL14H4	14	4	HIGH	35	90
PAL16H2	16	2	HIGH	35	90
PAL16C1	16	2	BOTH	40	90
PAL10L8	10	8	LOW	35	90
PAL12L6	12	6	LOW	35	90
PAL14L4	14	4	LOW	35	90
PAL16L2	16	2	LOW	35	90

Description

The PAL10H8 Series is made up of nine combinatorial 20-pin PAL devices. They implement simple combinatorial logic, with no feedback. Each has sixteen product terms total, divided among the outputs, with two to sixteen product terms per output.

Polarity

Both active high and active low versions are available for each architecture. The 16C1 offers both polarities of its single output.

Performance

The standard series has a propagation delay (t_{pd}) of 35 nanoseconds (ns), except for the 16C1 at 40 ns. Standard supply current is 90 milliamperes (mA).

Packages

The commercial PAL10H8 Series is available in the plastic DIP (N), ceramic DIP (J), plastic leaded chip carrier (NL), and small outline (SG) packages.

Combinatorial PAL10H8 Series

10H8, 12H6, 14H4, 16H2, 16C1, 10L8, 12L6, 14L4, 16L2

0257526 ADV MICRO PLA/PLE/ARRAYS

96D 27115 D

DIP/SO Pinouts

T-46-13-47

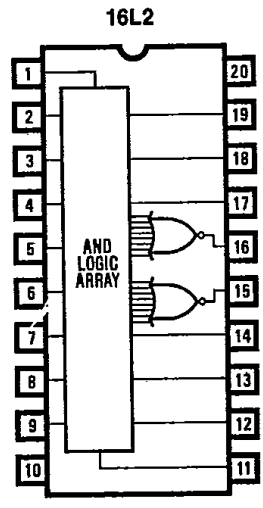
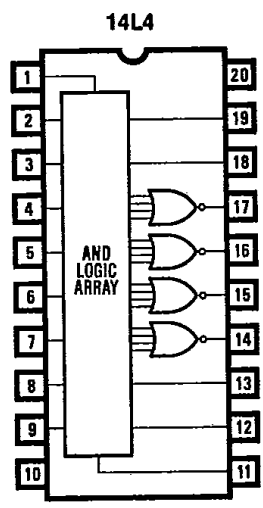
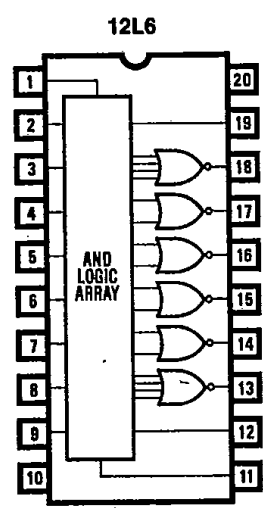
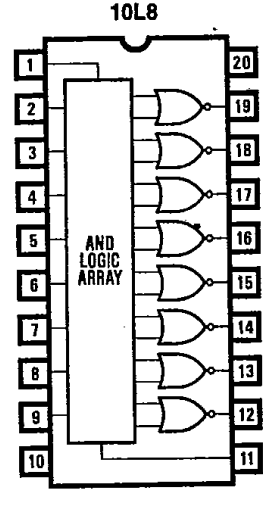
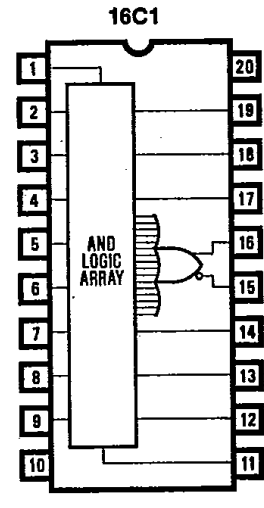
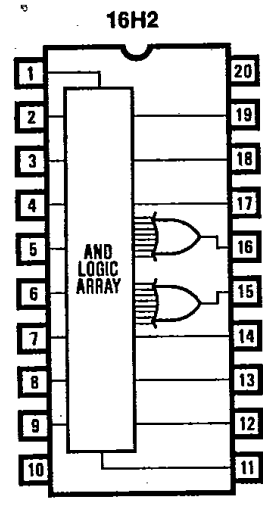
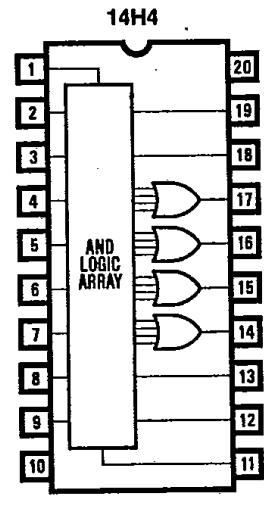
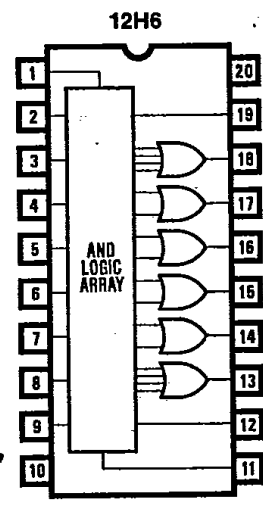
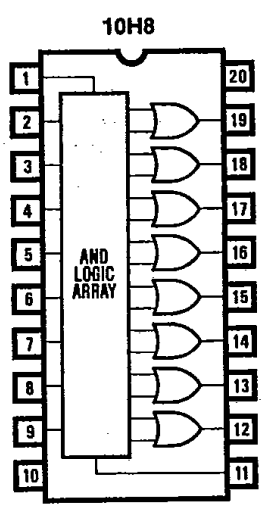

5

Combinatorial PAL10H8 Series
10H8, 12H6, 14H4, 16H2, 16C1, 10L8, 12L6, 14L4, 16L2

0257526 ADV MICRO PLA/PLE/ARRAYS

96D 27116 D

PLCC Pinouts

T-46-13-47

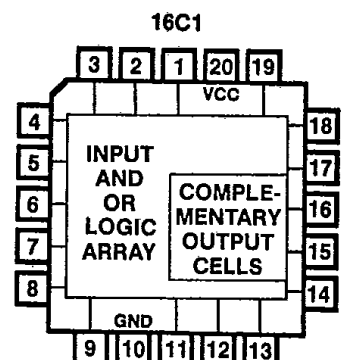
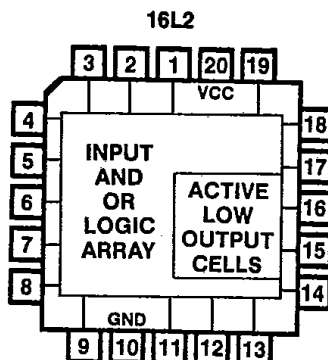
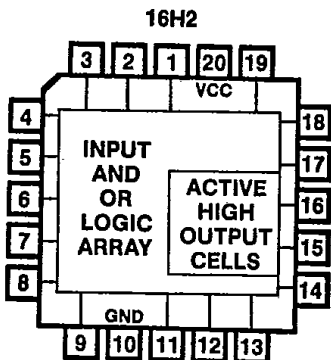
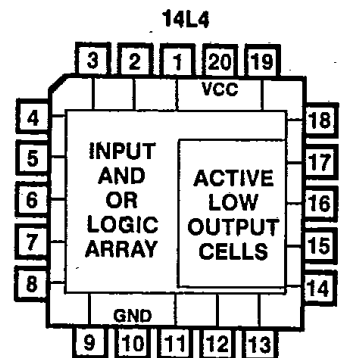
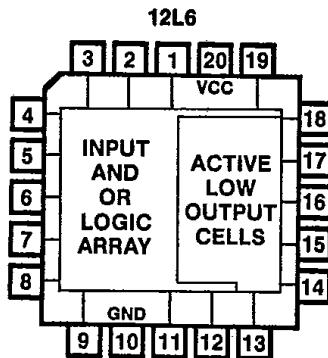
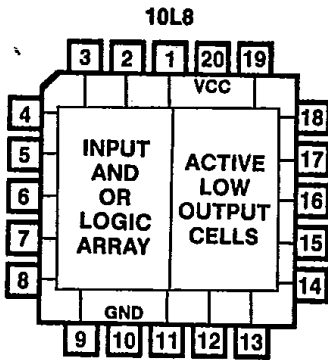
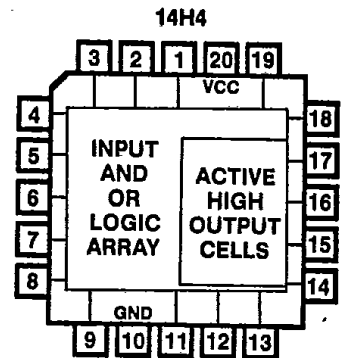
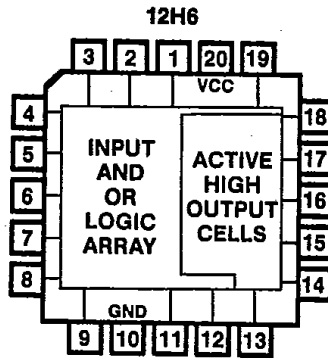
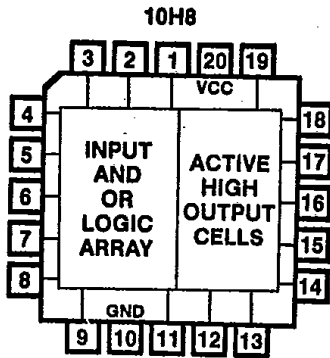

Package Drawings

(refer to PAL Device Package Outlines, page 3-179)

Combinatorial PAL10H8 Series
10H8, 12H6, 14H4, 16H2, 16C1, 10L8, 12L6, 14L4, 16L2

T-46-13-47

0257526 ADV MICRO PLA/PLE/ARRAYS

96D 27117 D =

Absolute Maximum Ratings

	Operating	Programming
Supply voltage V_{CC}	-0.5 V to 7.0 V	-0.5 V to 12.0 V
Input voltage	-1.5 V to 5.5 V	-1.0 V to 22.0 V
Off-state output voltage	5.5 V	12.0 V
Storage temperature	-65°C to +150°C	

Operating Conditions

SYMBOL	PARAMETER	MIN	TYP	MAX	UNIT
V_{CC}	Supply voltage	4.75	5	5.25	V
T_A	Operating free-air temperature	0	25	75	°C

Electrical Characteristics Over Operating Conditions

SYMBOL	PARAMETER	TEST CONDITIONS		MIN	TYP	MAX	UNIT
V_{IL}^1	Low-level input voltage					0.8	V
V_{IH}^1	High-level input voltage			2			V
V_{IC}	Input clamp voltage	$V_{CC} = \text{MIN}$	$I_I = -18 \text{ mA}$	-0.8	-1.5		V
I_{IL}^2	Low-level input current	$V_{CC} = \text{MAX}$	$V_I = 0.4 \text{ V}$	-0.02	-0.25		mA
I_{IH}	High-level input current	$V_{CC} = \text{MAX}$	$V_I = 2.4 \text{ V}$			25	μA
I_I	Maximum input current	$V_{CC} = \text{MAX}$	$V_I = 5.5 \text{ V}$			100	μA
V_{OL}	Low-level output voltage	$V_{CC} = \text{MIN}$	$I_{OL} = 8 \text{ mA}$		0.3	0.5	V
V_{OH}	High-level output voltage	$V_{CC} = \text{MIN}$	$I_{OH} = -3.2 \text{ mA}$	2.4	2.8		V
I_{OS}^2	Output short-circuit current	$V_{CC} = 5 \text{ V}$	$V_O = 0 \text{ V}$	-30	-70	-130	mA
I_{CC}	Supply current	$V_{CC} = \text{MAX}$			55	90	mA

Switching Characteristics Over Operating Conditions

SYMBOL	PARAMETER	TEST CONDITIONS	MIN	TYP	MAX	UNIT
t_{PD}	Input or feedback to output	Except 16C1	$R_1 = 560 \Omega$ $R_2 = 1.1 \text{ k}\Omega$	25	35	ns
		16C1		25	40	

5

1. These are absolute values with respect to the ground pin on the device and include all overshoots due to system and/or tester noise. Do not attempt to test these values without suitable equipment.
2. No more than one output should be shorted at a time, and duration of the short circuit should not exceed one second.

Combinatorial PAL10H8 Series
 10H8, 12H6, 14H4, 16H2, 16C1, 10L8, 12L6, 14L4, 16L2

0257526 ADV MICRO PLA/PLE/ARRAYS

96D 27118 D

Switching Waveforms

T-46-13-47

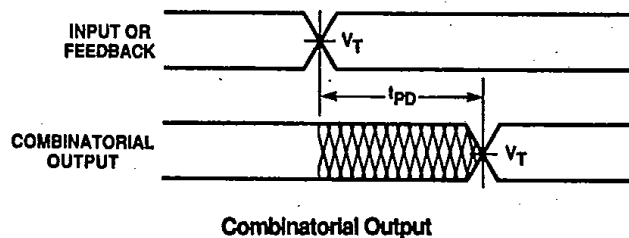

- Notes:
1. $V_T = 1.5V$.
 2. Input pulse amplitude 0 V to 3.0 V.
 3. Input rise and fall times 2-5 ns typical.

Switching Test Load

(refer to page 5-164)

Programmers/Development Systems

(refer to Programmer Reference Guide, page 3-81)

Schematic of Inputs and Outputs

(refer to page 5-164)

Combinatorial PAL10H8 Series

10H8, 12H6, 14H4, 16H2, 16C1, 10L8, 12L6, 14L4, 16L2

0257526 ADV MICRO PLA/PLE/ARRAYS

96D 27119 D

Logic Diagram

10H8

T-46-13-47

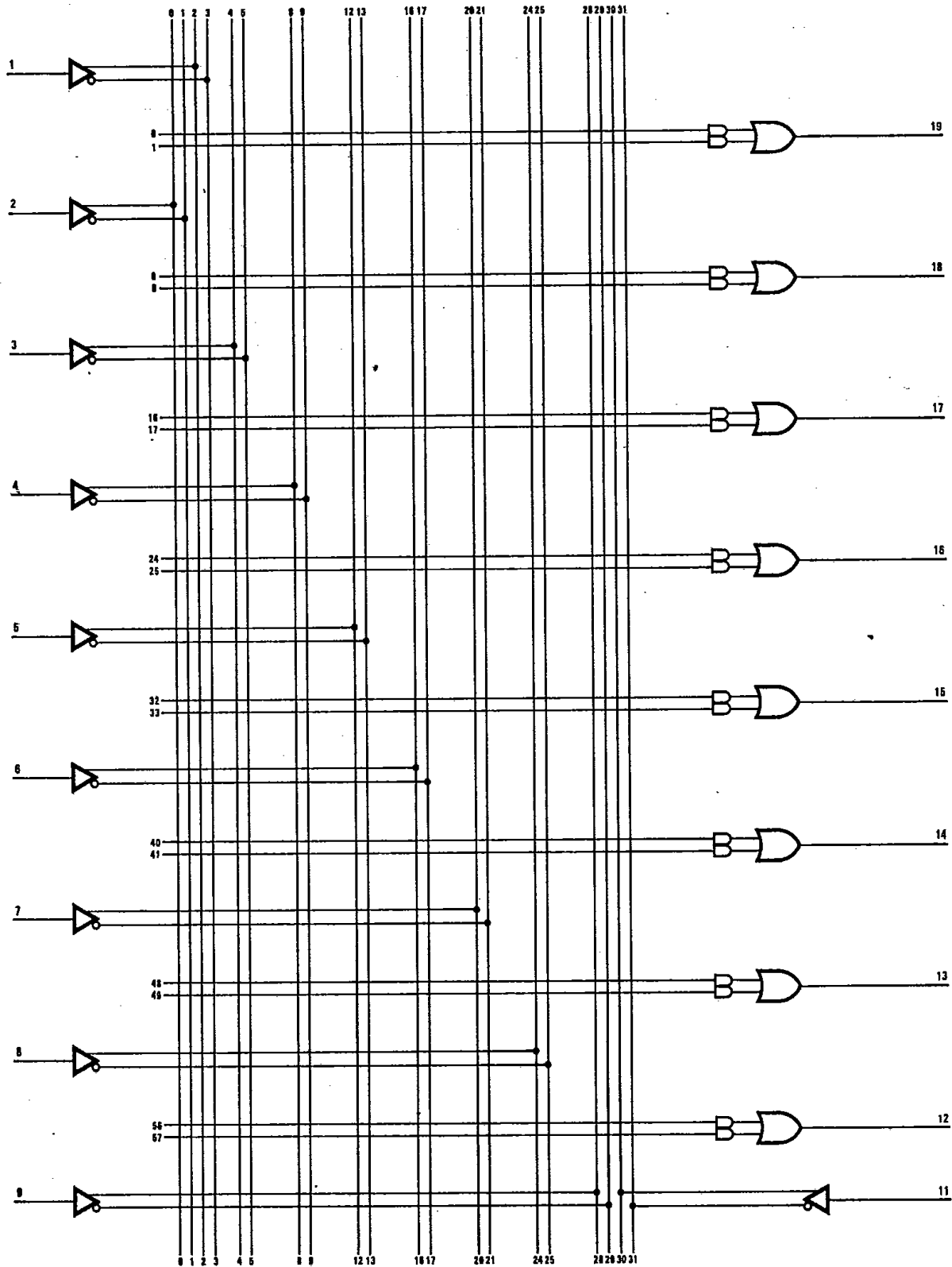

5

Combinatorial PAL10H8 Series
10H8, 12H6, 14H4, 16H2, 16C1, 10L8, 12L6, 14L4, 16L2

0257526 ADV MICRO PLA/PLE/ARRAYS

96D 27120

D

Logic Diagram

12H6

T-46-13-47

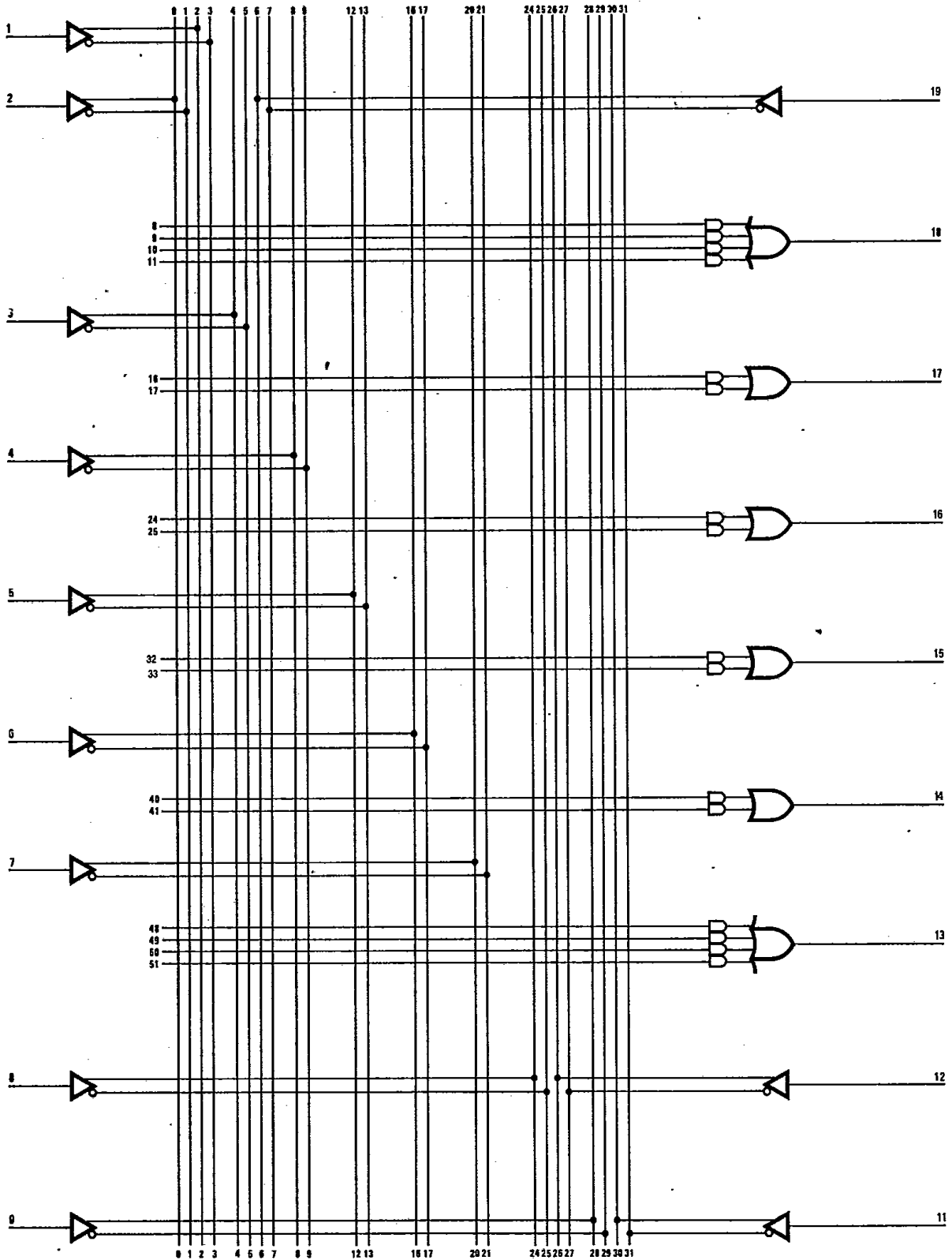

0257526 ADV MICRO PLA/PLE/ARRAYS 96D 27121 D

Logic Diagram

14H4

T-46-13-47

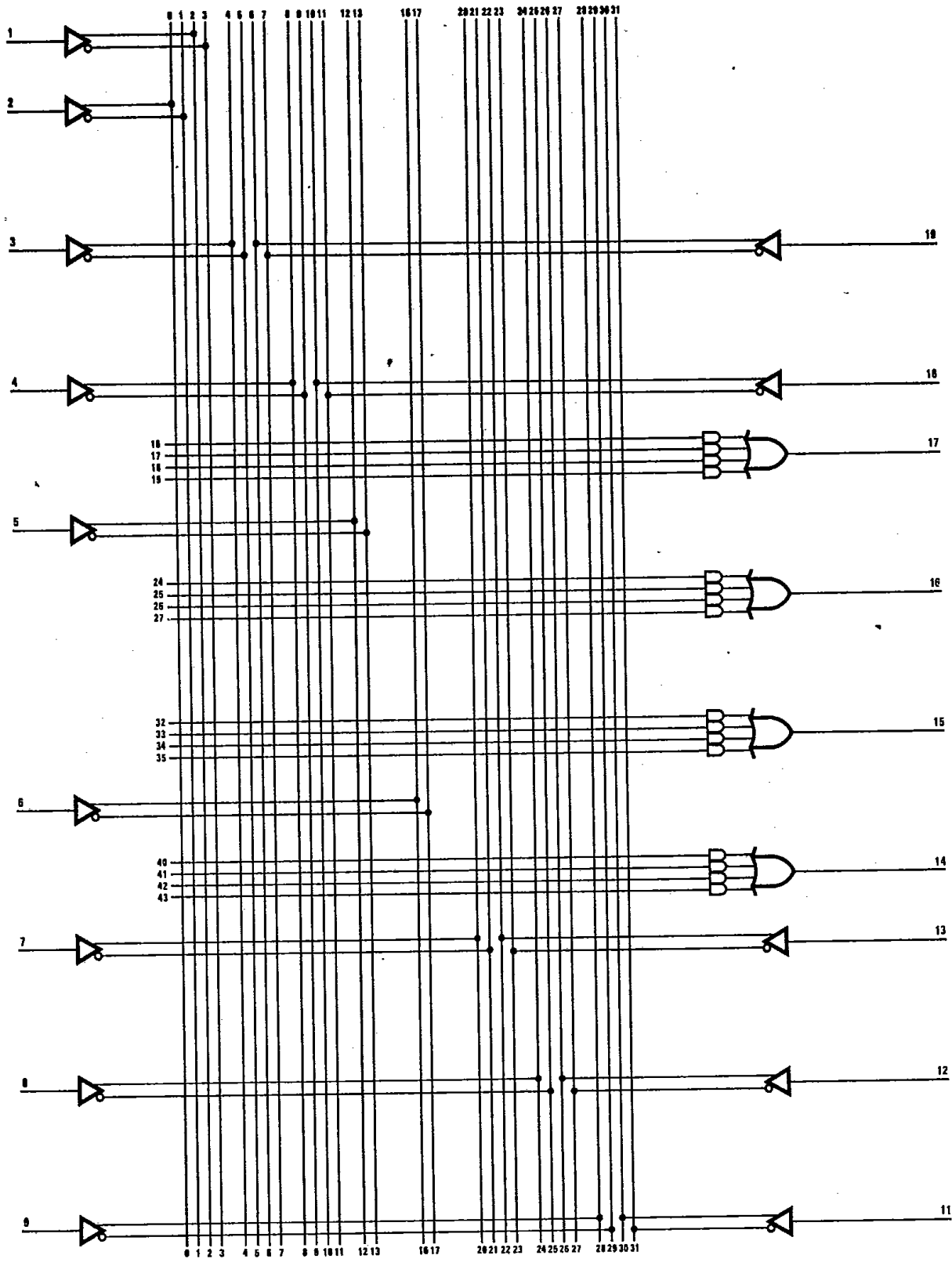

5

Combinatorial PAL10H8 Series

10H8, 12H6, 14H4, 16H2, 16C1, 10L8, 12L6, 14L4, 16L2

0257526 ADV MICRO PLA/PLE/ARRAYS

96D 27122 D

Logic Diagram

16H2

T-46-13-47

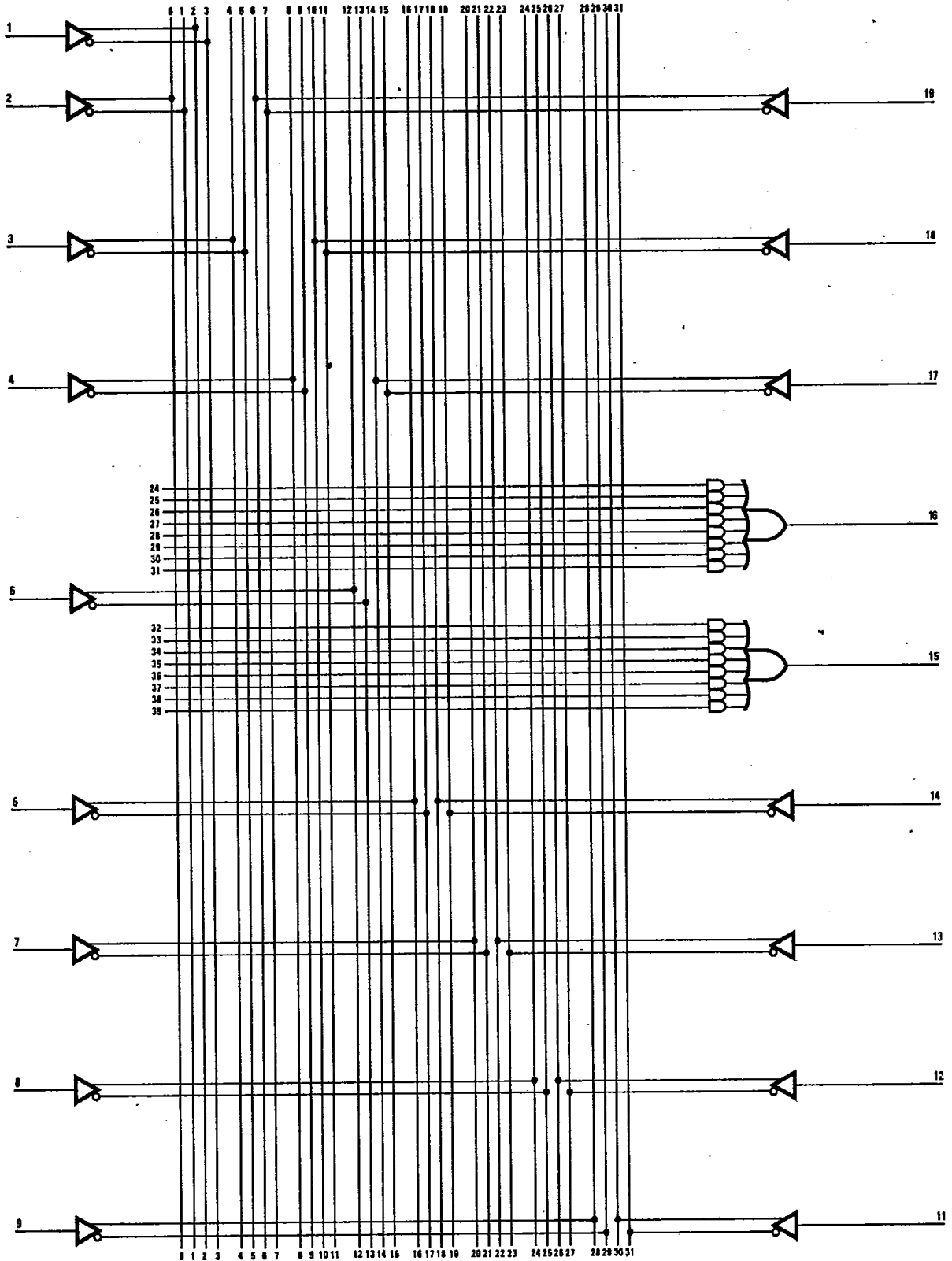

Logic Diagram

16C1

T-46-13-47

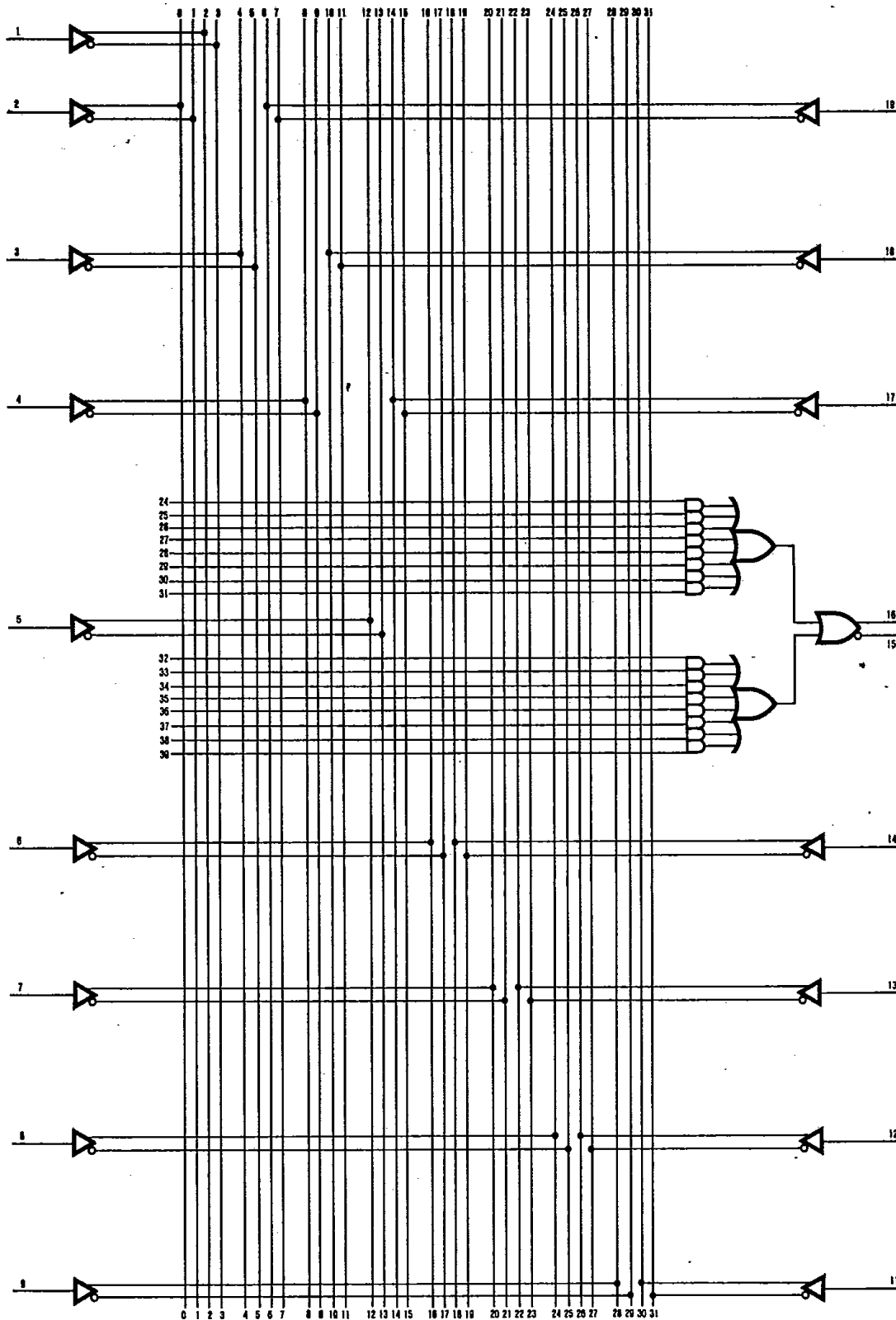

5

Combinatorial PAL10H8 Series
10H8, 12H6, 14H4, 16H2, 16C1, 10L8, 12L6, 14L4, 16L2

0257526 ADV MICRO PLA/PLE/ARRAYS

96D 27124 D

Logic Diagram

10L8

T-46-13-47

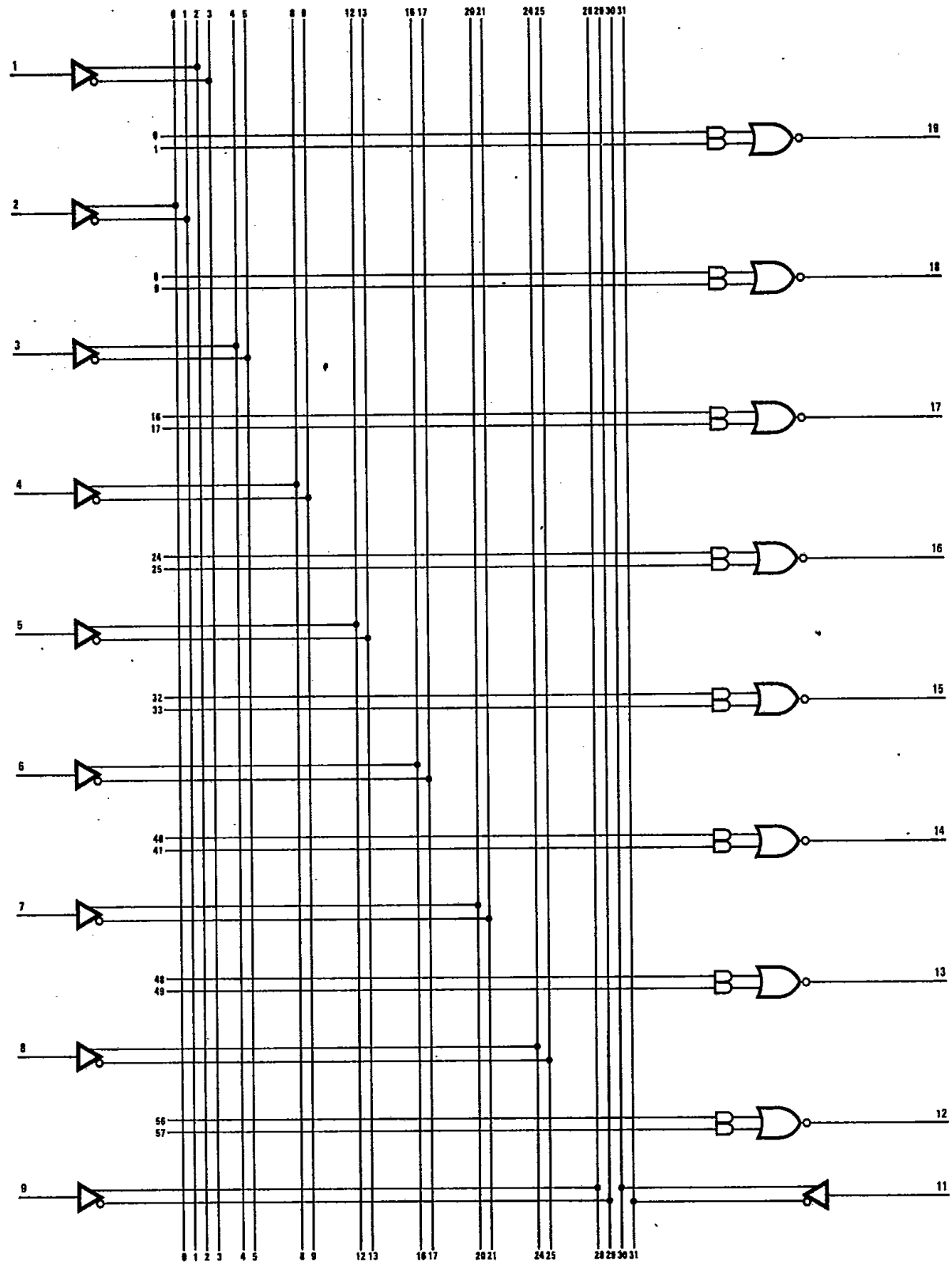

Logic Diagram

12L6

T-46-13-47

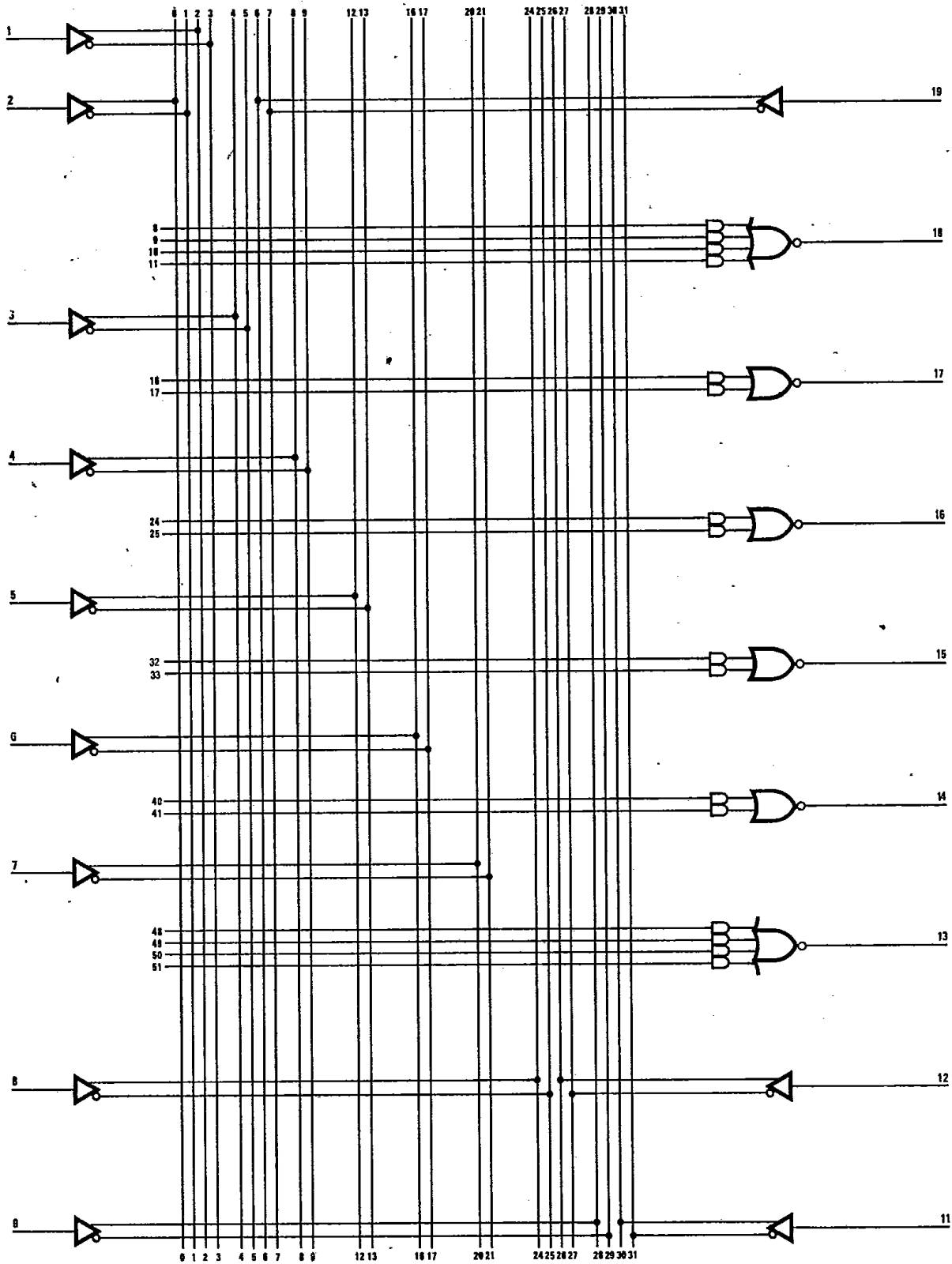

5

Combinatorial PAL10H8 Series

10H8, 12H6, 14H4, 16H2, 16C1, 10L8, 12L6, 14L4, 16L2

0257526 ADV MICRO PLA/PLE/ARRAYS

96D 27126 D

Logic Diagram

14L4

T-46-13-47

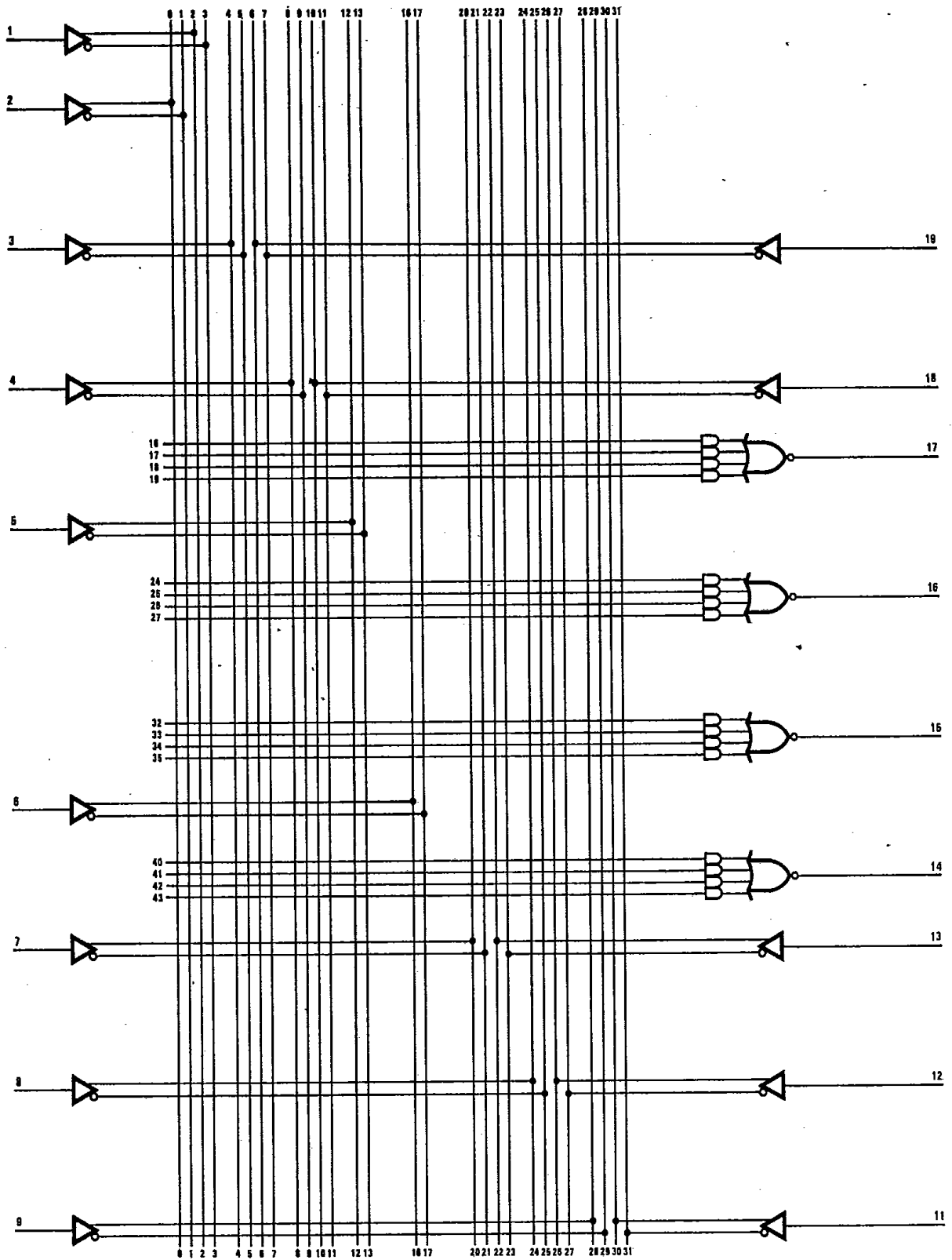

Combinatorial PAL10H8 Series

10H8, 12H6, 14H4, 16H2, 16C1, 10L8, 12L6, 14L4, 16L2

0257526 ADV MICRO PLA/PLE/ARRAYS

96D 27127 D

Logic Diagram

16L2

T-46-13-47

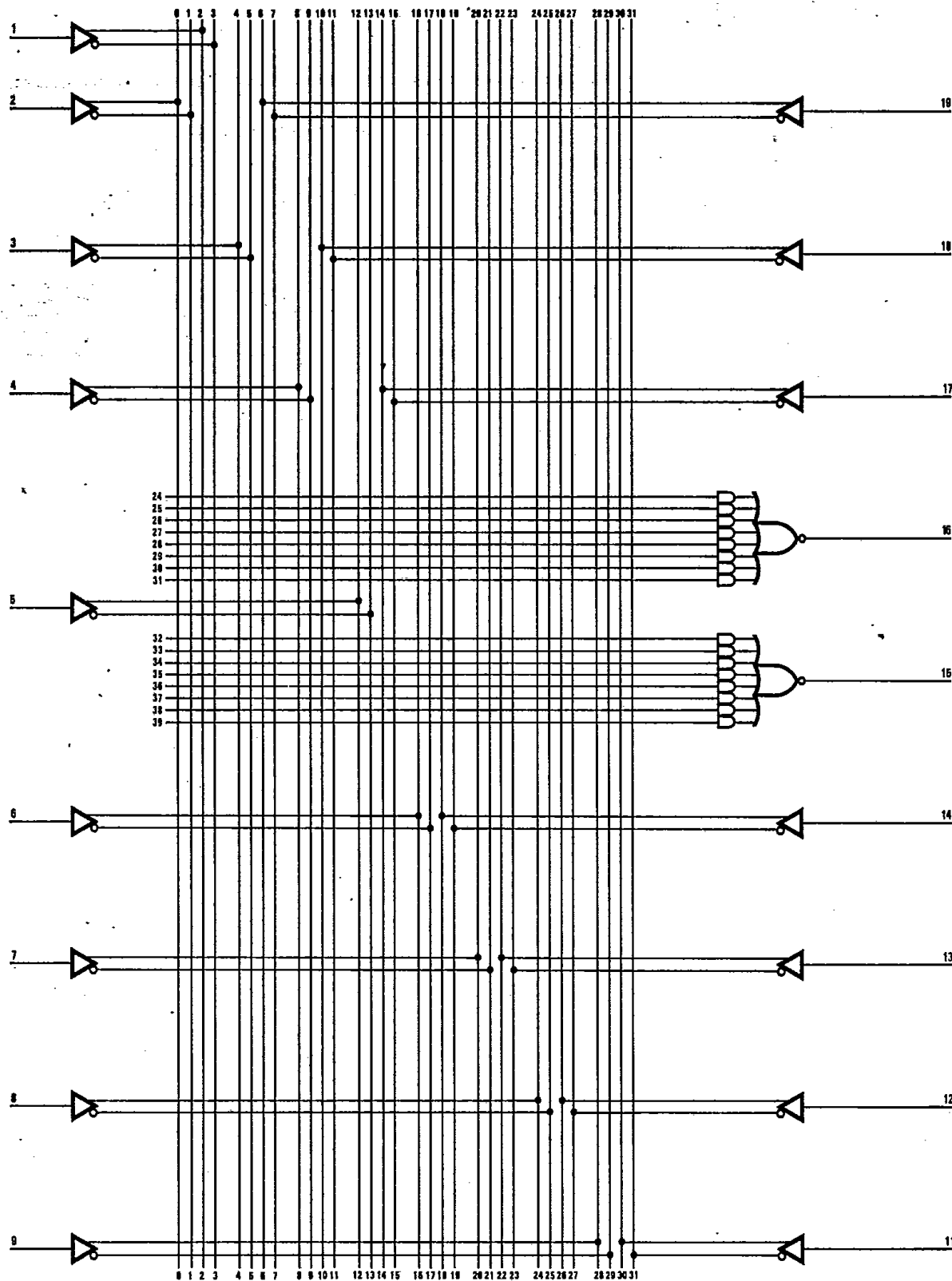

5