

Complementary Silicon Power Transistors

The 2N3773 and 2N6609 are PowerBase power transistors designed for high power audio, disk head positioners and other linear applications. These devices can also be used in power switching circuits such as relay or solenoid drivers, dc to dc converters or inverters.

- High Safe Operating Area (100% Tested) 150 W @ 100 V
- Completely Characterized for Linear Operation
- High DC Current Gain and Low Saturation Voltage
 - $h_{FE} = 15$ (Min) @ 8 A, 4 V
 - $V_{CE(sat)} = 1.4$ V (Max) @ $I_C = 8$ A, $I_B = 0.8$ A
- For Low Distortion Complementary Designs

NPN
2N3773*
PNP
2N6609

*Motorola Preferred Device

16 AMPERE
COMPLEMENTARY
POWER TRANSISTORS
140 VOLTS
150 WATTS

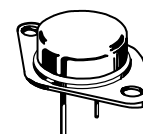

CASE 1-07
TO-204AA
(TO-3)

*MAXIMUM RATINGS

Rating	Symbol	Value	Unit
Collector Emitter Voltage	V_{CEO}	140	Vdc
Collector-Emitter Voltage	V_{CEX}	160	Vdc
Collector-Base Voltage	V_{CB0}	160	Vdc
Emitter-Base Voltage	V_{EBO}	7	Vdc
Collector Current — Continuous — Peak (1)	I_C	16 30	Adc
Base Current — Continuous — Peak (1)	I_B	4 15	Adc
Total Power Dissipation @ $T_C = 25^\circ\text{C}$ Derate above 25°C	P_D	150 0.855	Watts W/ $^\circ\text{C}$
Operating and Storage Junction Temperature Range	T_J, T_{stg}	-65 to +200	$^\circ\text{C}$

THERMAL CHARACTERISTICS

Characteristic	Symbol	Max	Unit
Thermal Resistance, Junction to Case	$R_{\theta JC}$	1.17	$^\circ\text{C/W}$

* Indicates JEDEC Registered Data.

(1) Pulse Test: Pulse Width = 5 ms, Duty Cycle \leq 10%.

Preferred devices are Motorola recommended choices for future use and best overall value.

REV 7

2N3773 2N6609

ELECTRICAL CHARACTERISTICS ($T_C = 25^\circ\text{C}$ unless otherwise noted)

Characteristic	Symbol	Min	Max	Unit
OFF CHARACTERISTICS (1)				
*Collector–Emitter Breakdown Voltage ($I_C = 0.2\text{ Adc}$, $I_B = 0$)	$V_{CEO(sus)}$	140	—	Vdc
*Collector–Emitter Sustaining Voltage ($I_C = 0.1\text{ Adc}$, $V_{BE(off)} = 1.5\text{ Vdc}$, $R_{BE} = 100\text{ Ohms}$)	$V_{CEX(sus)}$	160	—	Vdc
Collector–Emitter Sustaining Voltage ($I_C = 0.2\text{ Adc}$, $R_{BE} = 100\text{ Ohms}$)	$V_{CER(sus)}$	150	—	Vdc
*Collector Cutoff Current ($V_{CE} = 120\text{ Vdc}$, $I_B = 0$)	I_{CEO}	—	10	mAdc
*Collector Cutoff Current ($V_{CE} = 140\text{ Vdc}$, $V_{BE(off)} = 1.5\text{ Vdc}$) ($V_{CE} = 140\text{ Vdc}$, $V_{BE(off)} = 1.5\text{ Vdc}$, $T_C = 150^\circ\text{C}$)	I_{CEX}	— —	2 10	mAdc
Collector Cutoff Current ($V_{CB} = 140\text{ Vdc}$, $I_E = 0$)	I_{CBO}	—	2	mAdc
*Emitter Cutoff Current ($V_{BE} = 7\text{ Vdc}$, $I_C = 0$)	I_{EBO}	—	5	mAdc
ON CHARACTERISTICS (1)				
DC Current Gain *($I_C = 8\text{ Adc}$, $V_{CE} = 4\text{ Vdc}$) ($I_C = 16\text{ Adc}$, $V_{CE} = 4\text{ Vdc}$)	h_{FE}	15 5	60 —	—
Collector–Emitter Saturation Voltage *($I_C = 8\text{ Adc}$, $I_B = 800\text{ mAdc}$) ($I_C = 16\text{ Adc}$, $I_B = 3.2\text{ Adc}$)	$V_{CE(sat)}$	— —	1.4 4	Vdc
*Base–Emitter On Voltage ($I_C = 8\text{ Adc}$, $V_{CE} = 4\text{ Vdc}$)	$V_{BE(on)}$	—	2.2	Vdc
DYNAMIC CHARACTERISTICS				
Magnitude of Common–Emitter Small–Signal, Short–Circuit, Forward Current Transfer Ratio ($I_C = 1\text{ A}$, $f = 50\text{ kHz}$)	$ h_{fe} $	4	—	—
*Small–Signal Current Gain ($I_C = 1\text{ Adc}$, $V_{CE} = 4\text{ Vdc}$, $f = 1\text{ kHz}$)	h_{fe}	40	—	—
SECOND BREAKDOWN CHARACTERISTICS				
Second Breakdown Collector Current with Base Forward Biased $t = 1\text{ s}$ (non–repetitive), $V_{CE} = 100\text{ V}$, See Figure 12	$I_{S/b}$	1.5	—	Adc

(1) Pulse Test: Pulse Width = 300 μs , Duty Cycle $\leq 2\%$.

* Indicates JEDEC Registered Data.

NPN

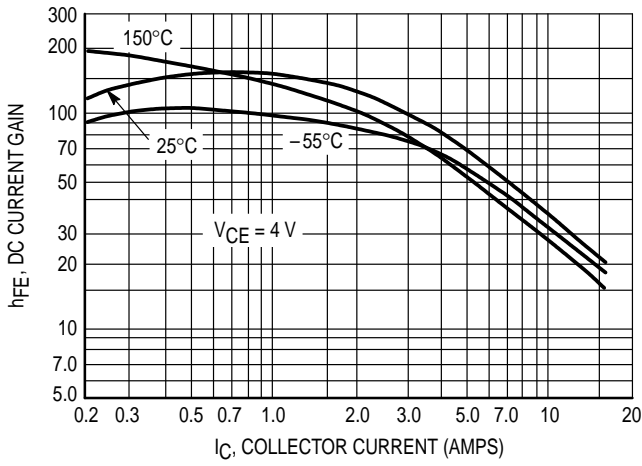

Figure 1. DC Current Gain

PNP

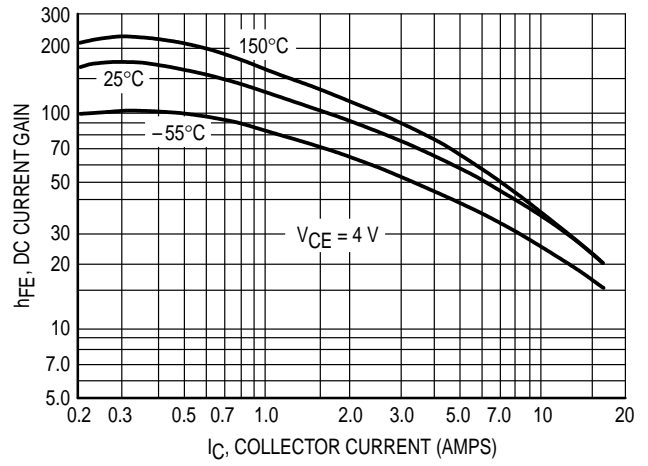

Figure 2. DC Current Gain

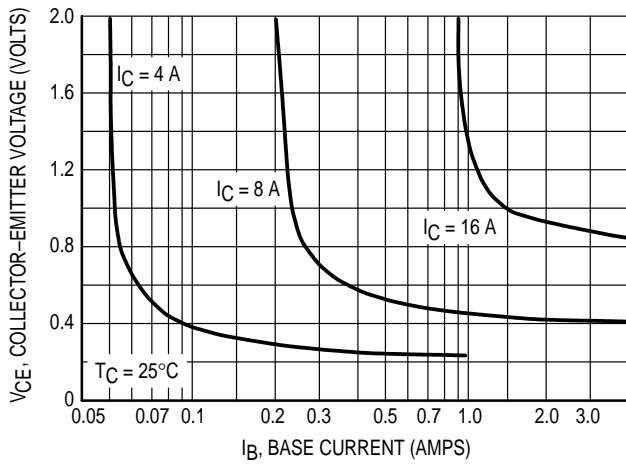

Figure 3. Collector Saturation Region

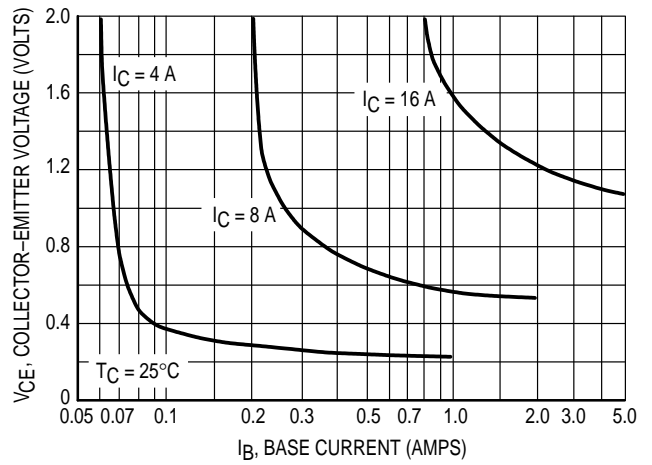

Figure 4. Collector Saturation Region

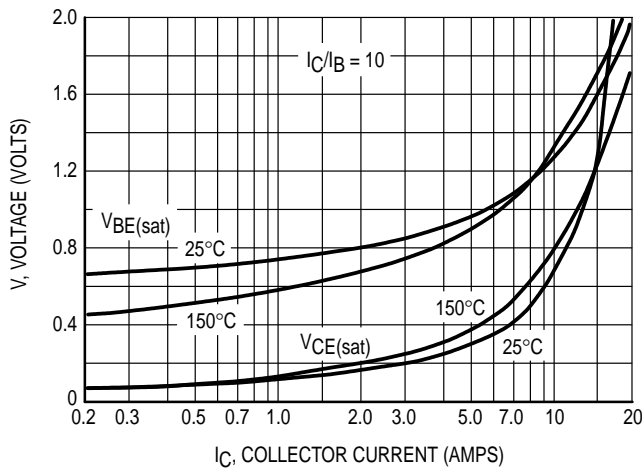

Figure 5. "On" Voltage

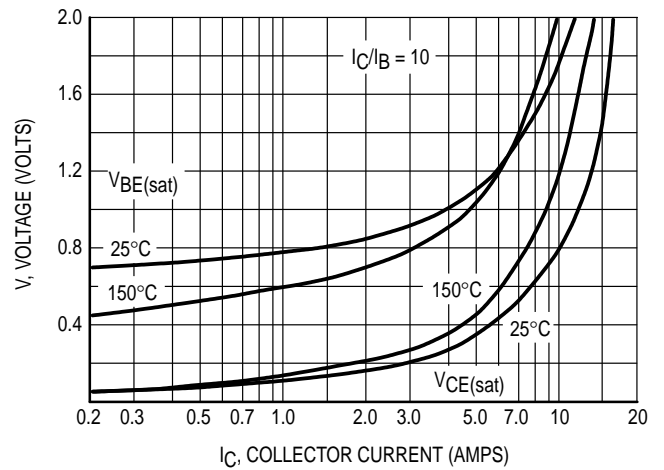

Figure 6. "On" Voltage

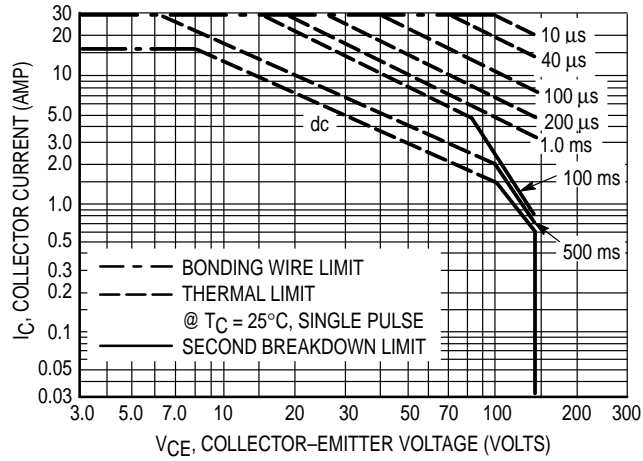

Figure 7. Forward Bias Safe Operating Area

There are two limitations on the power handling ability of a transistor: average junction temperature and second breakdown. Safe operating area curves indicate $I_C - V_{CE}$ limits of the transistor that must be observed for reliable operation: i.e., the transistor must not be subjected to greater dissipation than the curves indicate.

The data of Figure 7 is based on $T_{J(pk)} = 200^\circ\text{C}$; T_C is variable depending on conditions. Second breakdown pulse limits are valid for duty cycles to 10% provided $T_{J(pk)} < 200^\circ\text{C}$. At high case temperatures, thermal limitations will reduce the power that can be handled to values less than the limitations imposed by second breakdown.

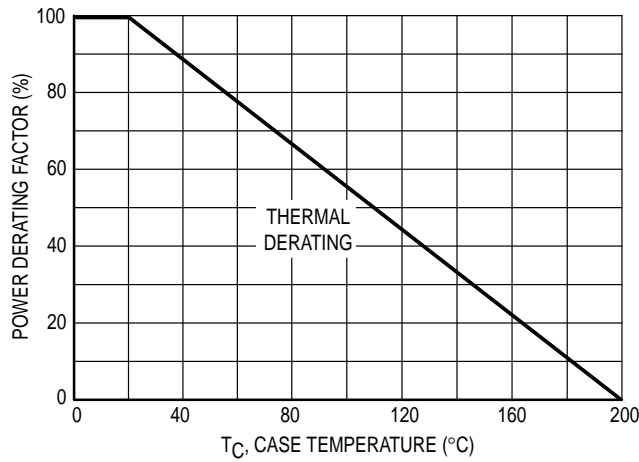
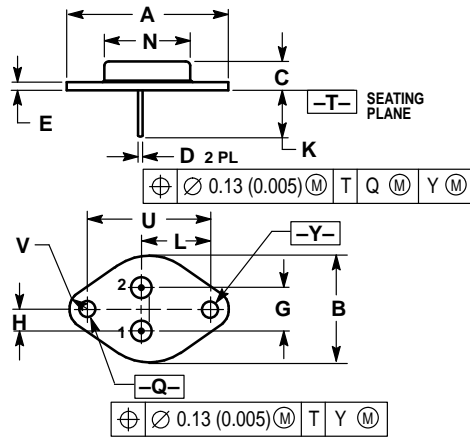

Figure 8. Power Derating

PACKAGE DIMENSIONS



- NOTES:
1. DIMENSIONING AND TOLERANCING PER ANSI Y14.5M, 1982.
 2. CONTROLLING DIMENSION: INCH.
 3. ALL RULES AND NOTES ASSOCIATED WITH REFERENCED TO-204AA OUTLINE SHALL APPLY.

DIM	INCHES		MILLIMETERS	
	MIN	MAX	MIN	MAX
A	1.550 REF		39.37 REF	
B	—	1.050	—	26.67
C	0.250	0.335	6.35	8.51
D	0.038	0.043	0.97	1.09
E	0.055	0.070	1.40	1.77
G	0.430 BSC		10.92 BSC	
H	0.215 BSC		5.46 BSC	
K	0.440	0.480	11.18	12.19
L	0.665 BSC		16.89 BSC	
N	—	0.830	—	21.08
Q	0.151	0.165	3.84	4.19
U	1.187 BSC		30.15 BSC	
V	0.131	0.188	3.33	4.77

STYLE 1:
 PIN 1. BASE
 2. EMITTER
 CASE: COLLECTOR

CASE 1-07
 TO-204AA (TO-3)
 ISSUE Z

Motorola reserves the right to make changes without further notice to any products herein. Motorola makes no warranty, representation or guarantee regarding the suitability of its products for any particular purpose, nor does Motorola assume any liability arising out of the application or use of any product or circuit, and specifically disclaims any and all liability, including without limitation consequential or incidental damages. "Typical" parameters can and do vary in different applications. All operating parameters, including "Typicals" must be validated for each customer application by customer's technical experts. Motorola does not convey any license under its patent rights nor the rights of others. Motorola products are not designed, intended, or authorized for use as components in systems intended for surgical implant into the body, or other applications intended to support or sustain life, or for any other application in which the failure of the Motorola product could create a situation where personal injury or death may occur. Should Buyer purchase or use Motorola products for any such unintended or unauthorized application, Buyer shall indemnify and hold Motorola and its officers, employees, subsidiaries, affiliates, and distributors harmless against all claims, costs, damages, and expenses, and reasonable attorney fees arising out of, directly or indirectly, any claim of personal injury or death associated with such unintended or unauthorized use, even if such claim alleges that Motorola was negligent regarding the design or manufacture of the part. Motorola and  are registered trademarks of Motorola, Inc. Motorola, Inc. is an Equal Opportunity/Affirmative Action Employer.

How to reach us:

USA / EUROPE: Motorola Literature Distribution;
P.O. Box 20912; Phoenix, Arizona 85036. 1-800-441-2447

JAPAN: Nippon Motorola Ltd.; Tatsumi-SPD-JLDC, Toshikatsu Otsuki,
6F Seibu-Butsuryu-Center, 3-14-2 Tatsumi Koto-Ku, Tokyo 135, Japan. 03-3521-8315

MFAX: RMFAX0@email.sps.mot.com – TOUCHTONE (602) 244-6609
INTERNET: <http://Design-NET.com>

HONG KONG: Motorola Semiconductors H.K. Ltd.; 8B Tai Ping Industrial Park,
51 Ting Kok Road, Tai Po, N.T., Hong Kong. 852-26629298

