

IR2213(S) & (PbF)

HIGH AND LOW SIDE DRIVER

Features

- Floating channel designed for bootstrap operation
 Fully operational to +1200V
 Tolerant to negative transient voltage
 dV/dt immune
- Gate drive supply range from 12 to 20V
- Undervoltage lockout for both channels
- 3.3V logic compatible
 Separate logic supply range from 3.3V to 20V
 Logic and power ground $\pm 5V$ offset
- CMOS Schmitt-triggered inputs with pull-down
- Cycle by cycle edge-triggered shutdown logic
- Matched propagation delay for both channels
- Outputs in phase with inputs
- Also available LEAD-FREE (PbF)

Description

The IR2213(S) is a high voltage, high speed power MOSFET and IGBT driver with independent high and low side referenced output channels. Proprietary HVIC and latch immune CMOS technologies enable ruggedized monolithic construction. Logic inputs are compatible with standard CMOS or LSTTL outputs, down to 3.3V logic. The output drivers feature a high pulse current buffer stage designed for minimum driver cross-conduction. Propagation delays are matched to simplify use in high frequency applications. The floating channel can be used to drive an N-channel power MOSFET or IGBT in the high side configuration which operates up to 1200 volts.

Product Summary

V_{OFFSET}	1200V max.
I_{O+/-}	1.7A / 2A
V_{OUT}	12 - 20V
t_{on/off} (typ.)	280 & 225 ns
Delay Matching	30 ns

Packages

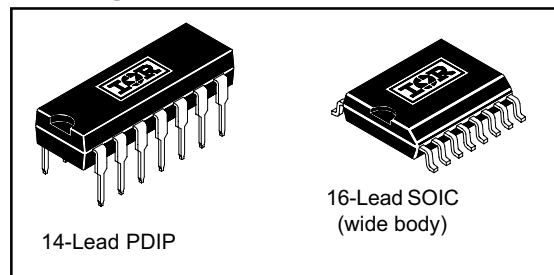

Typical Connection

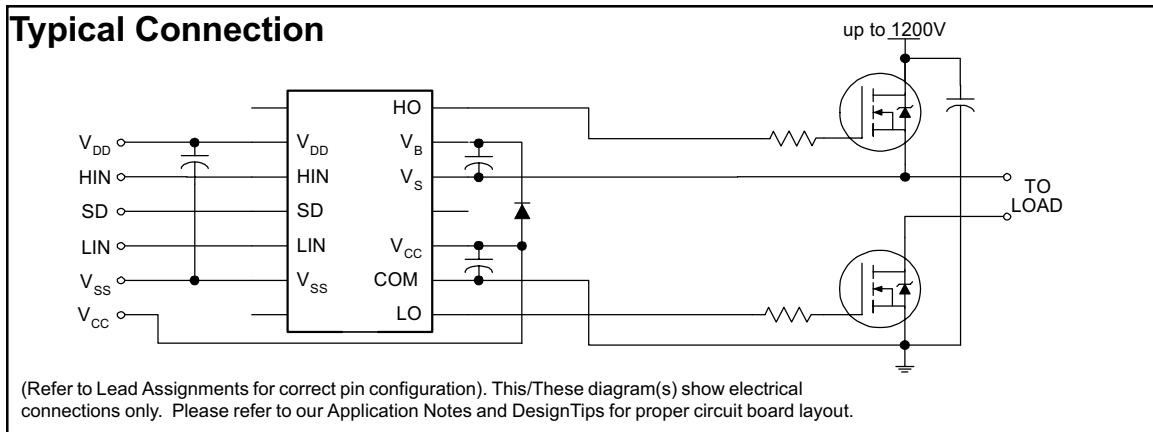

IR2213(S) & (PbF)

Absolute Maximum Ratings

Absolute Maximum Ratings indicate sustained limits beyond which damage to the device may occur. All voltage parameters are absolute voltages referenced to COM. The Thermal Resistance and Power Dissipation ratings are measured under board mounted and still air conditions.

Symbol	Definition	Min.	Max.	Units	
V _B	High Side Floating Supply Voltage	-0.3	1225		
V _S	High Side Floating Supply Offset Voltage	V _B - 25	V _B + 0.3	V	
V _{HO}	High Side Floating Output Voltage	V _S - 0.3	V _B + 0.3		
V _{CC}	Low Side Fixed Supply Voltage	-0.3	25		
V _{LO}	Low Side Output Voltage	-0.3	V _{CC} + 0.3		
V _{DD}	Logic Supply Voltage	-0.3	V _{SS} + 25		
V _{SS}	Logic Supply Offset Voltage	V _{CC} - 25	V _{CC} + 0.3		
V _{IN}	Logic Input Voltage (HIN, LIN & SD)	V _{SS} - 0.3	V _{DD} + 0.3		
dV _S /dt	Allowable Offset Supply Voltage Transient (Figure 2)	—	50		V/ns
P _D	Package Power Dissipation @ T _A ≤ +25°C	(14 Lead PDIP)	—	1.6	W
		(16 Lead SOIC)	—	1.25	
R _{THJA}	Thermal Resistance, Junction to Ambient	(14 Lead PDIP)	—	75	°C/W
		(16 Lead SOIC)	—	100	
T _J	Junction Temperature	—	125	°C	
T _S	Storage Temperature	-55	150		
T _L	Lead Temperature (Soldering, 10 seconds)	—	300		

Recommended Operating Conditions

The Input/Output logic timing diagram is shown in Figure 1. For proper operation the device should be used within the recommended conditions. The V_S and V_{SS} offset ratings are tested with all supplies biased at 15V differential.

Symbol	Definition	Min.	Max.	Units
V _B	High Side Floating Supply Absolute Voltage	V _S + 12	V _S + 20	V
V _S	High Side Floating Supply Offset Voltage	Note 1	1200	
V _{HO}	High Side Floating Output Voltage	V _S	V _B	
V _{CC}	Low Side Fixed Supply Voltage	12	20	
V _{LO}	Low Side Output Voltage	0	V _{CC}	
V _{DD}	Logic Supply Voltage	V _{SS} + 3	V _{SS} + 20	
V _{SS}	Logic Supply Offset Voltage	-5 (Note 2)	5	
V _{IN}	Logic Input Voltage (HIN, LIN & SD)	V _{SS}	V _{DD}	

Note 1: Logic operational for V_S of -5 to +1200V. Logic state held for V_S of -5V to -V_B. (Please refer to the Design Tip DT97-3 for more details).

Note 2: When V_{DD}<5V, the minimum V_{SS} offset is limited to -V_{DD}

Dynamic Electrical Characteristics

V_{BIAS} (V_{CC} , V_{BS} , V_{DD}) = 15V, C_L = 1000 pF, T_A = 25°C and V_{SS} = COM unless otherwise specified. The dynamic electrical characteristics are measured using the test circuit shown in Figure 3.

Symbol	Definition	Min.	Typ.	Max.	Units	Test Conditions
t_{on}	Turn-On Propagation Delay	—	280	—	ns	$V_S = 0V$
t_{off}	Turn-Off Propagation Delay	—	225	—		$V_S = 1200V$
t_{sd}	Shutdown Propagation Delay	—	230	—		$V_S = 1200V$
t_r	Turn-On Rise Time	—	25	—		
t_f	Turn-Off Fall Time	—	17	—		
MT	Delay Matching, HS & LS Turn-On/Off	—	—	30		

Static Electrical Characteristics

V_{BIAS} (V_{CC} , V_{BS} , V_{DD}) = 15V, T_A = 25°C and V_{SS} = COM unless otherwise specified. The V_{IN} , V_{TH} and I_{IN} parameters are referenced to V_{SS} and are applicable to all three logic input leads: HIN, LIN and SD. The V_O and I_O parameters are referenced to COM and are applicable to the respective output leads: HO or LO.

Symbol	Definition	Min.	Typ.	Max.	Units	Test Conditions
V_{IH}	Logic "1" Input Voltage	9.5	—	—	V	
V_{IL}	Logic "0" Input Voltage	—	—	6.0		
V_{OH}	High Level Output Voltage, $V_{BIAS} - V_O$	—	—	1.2		$I_O = 0A$
V_{OL}	Low Level Output Voltage, V_O	—	—	0.1		$I_O = 0A$
I_{LK}	Offset Supply Leakage Current	—	—	50	μA	$V_B = V_S = 1200V$
I_{QBS}	Quiescent V_{BS} Supply Current	—	125	230		$V_{IN} = 0V$ or V_{DD}
I_{QCC}	Quiescent V_{CC} Supply Current	—	180	340		$V_{IN} = 0V$ or V_{DD}
I_{QDD}	Quiescent V_{DD} Supply Current	—	15	30		$V_{IN} = 0V$ or V_{DD}
I_{IN+}	Logic "1" Input Bias Current	—	20	40		$V_{IN} = V_{DD}$
I_{IN-}	Logic "0" Input Bias Current	—	—	1.0	$V_{IN} = 0V$	
V_{BSUV+}	V_{BS} Supply Undervoltage Positive Going Threshold	8.7	10.2	11.7	V	
V_{BSUV-}	V_{BS} Supply Undervoltage Negative Going Threshold	7.9	9.3	10.7		
V_{CCUV+}	V_{CC} Supply Undervoltage Positive Going Threshold	8.7	10.2	11.7		
V_{CCUV-}	V_{CC} Supply Undervoltage Negative Going Threshold	7.9	9.3	10.7		
I_{O+}	Output High Short Circuit Pulsed Current	1.7	2.0	—	A	$V_O = 0V$, $V_{IN} = V_{DD}$ $PW \leq 10 \mu s$
I_{O-}	Output Low Short Circuit Pulsed Current	2.0	2.5	—		$V_O = 15V$, $V_{IN} = 0V$ $PW \leq 10 \mu s$

IR2213(S) & (PbF)

International
IR Rectifier

Functional Block Diagram

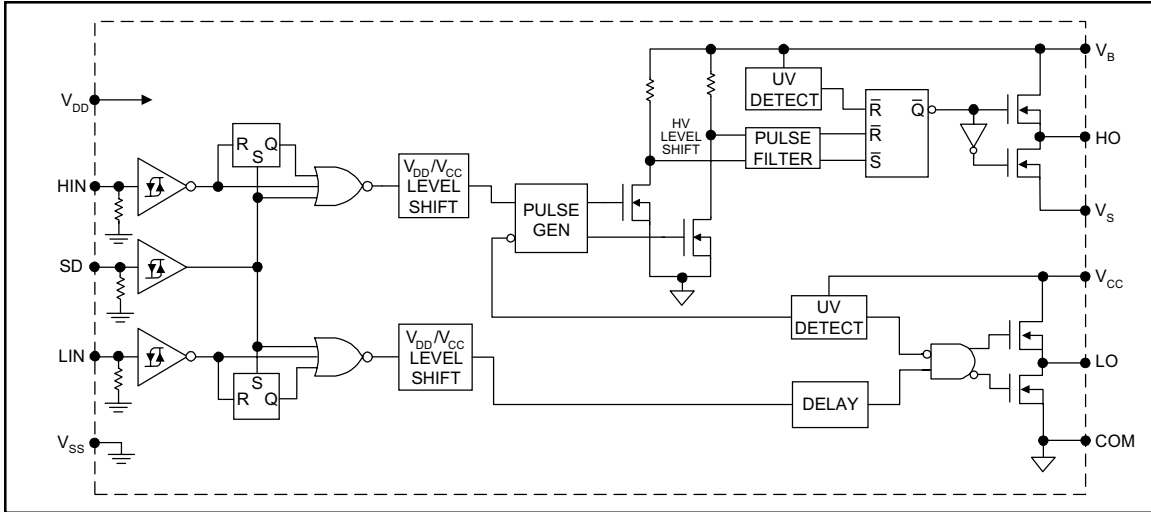

Lead Definitions

Symbol	Description
VDD	Logic supply
HIN	Logic input for high side gate driver output (HO), in phase
SD	Logic input for shutdown
LIN	Logic input for low side gate driver output (LO), in phase
VSS	Logic ground
VB	High side floating supply
HO	High side gate drive output
VS	High side floating supply return
VCC	Low side supply
LO	Low side gate drive output
COM	Low side return

Lead Assignments

<p>14 Lead PDIP</p>	<p>16 Lead SOIC (Wide Body)</p>
IR2213	IR2213S
Part Number	

IR2213(s) & (PbF)

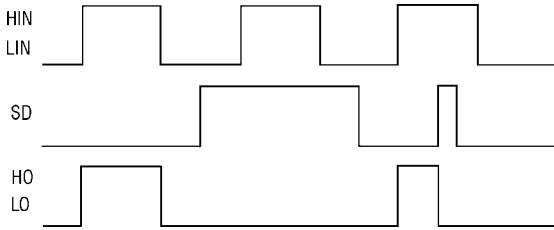

Figure 1. Input/Output Timing Diagram

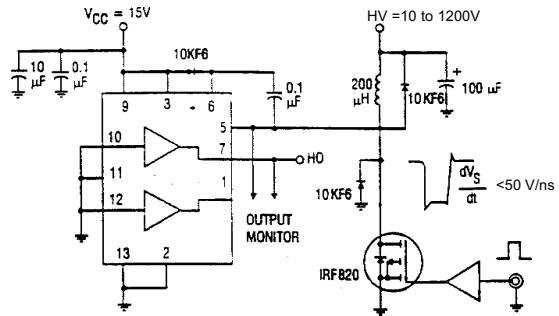

Figure 2. Floating Supply Voltage Transient Test Circuit

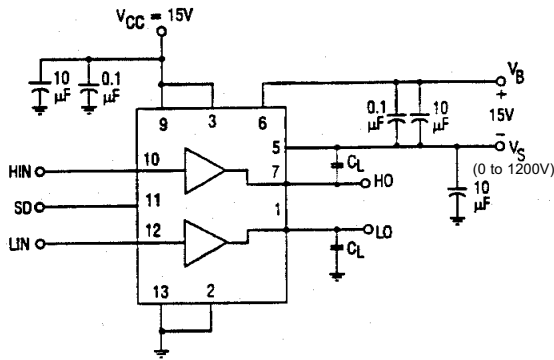

Figure 3. Switching Time Test Circuit

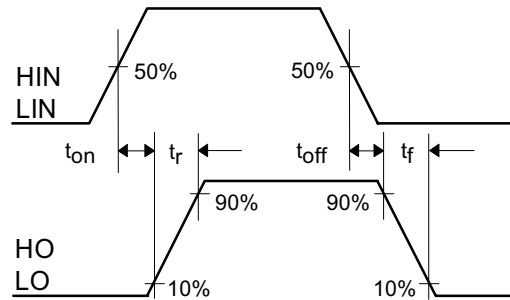

Figure 4. Switching Time Waveform Definition

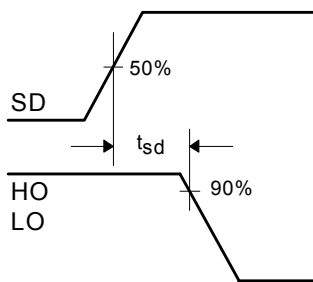

Figure 5. Shutdown Waveform Definitions

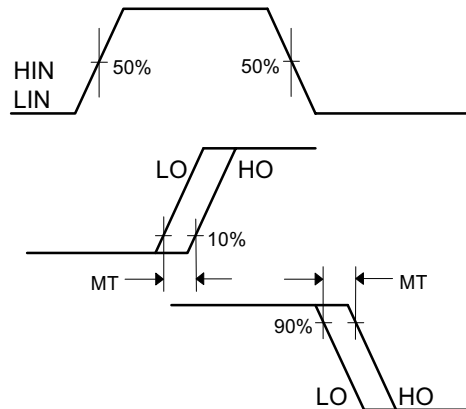

Figure 6. Delay Matching Waveform Definitions

IR2213(S) & (PbF)

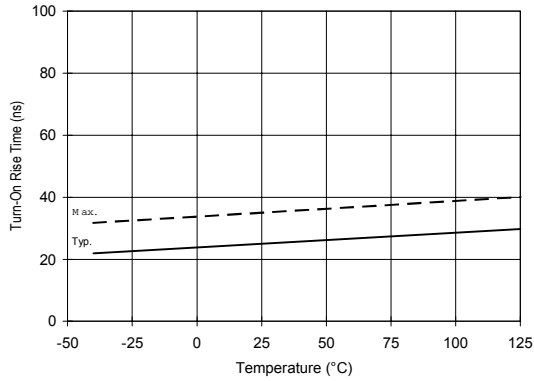

Figure 10A. Turn-On Rise Time vs. Temperature

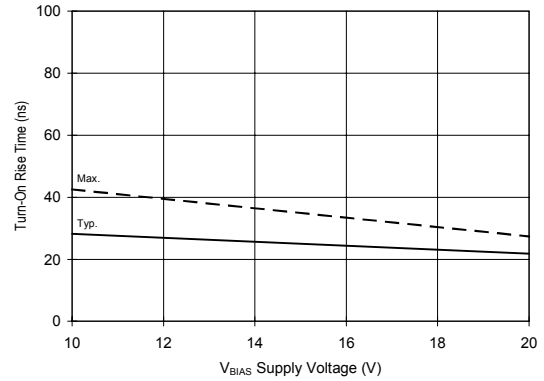

Figure 10B. Turn-On Rise Time vs. Voltage

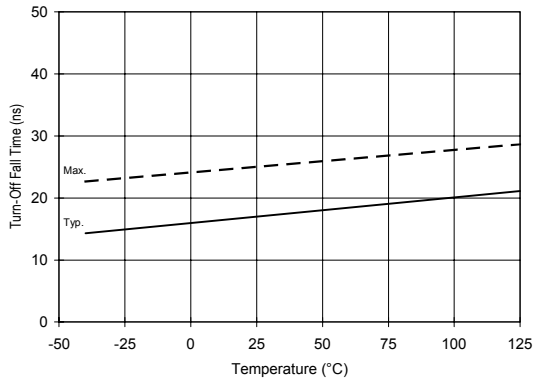

Figure 11A. Turn-Off Fall Time vs. Temperature

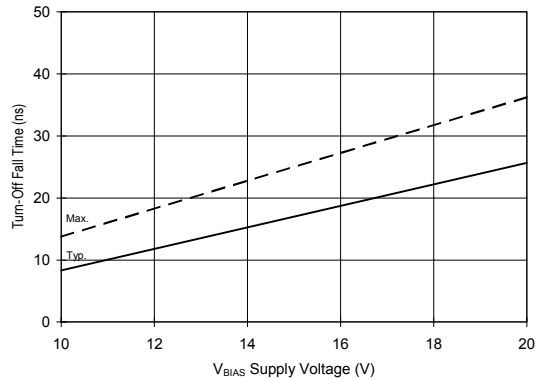

Figure 11B. Turn-Off Fall Time vs. Voltage

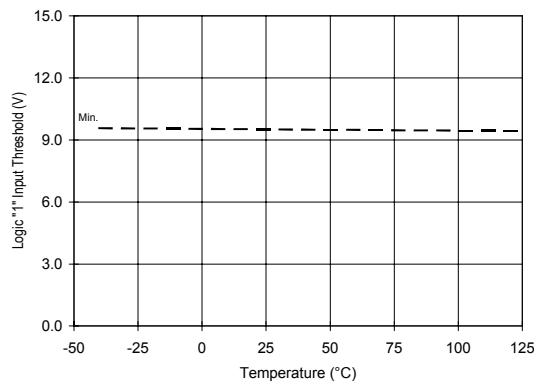

Figure 12A. Logic "1" Input Threshold vs. Temperature

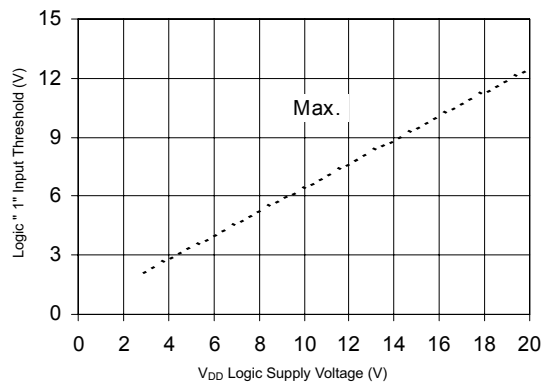

Figure 12B. Logic "1" Input Threshold vs. Voltage

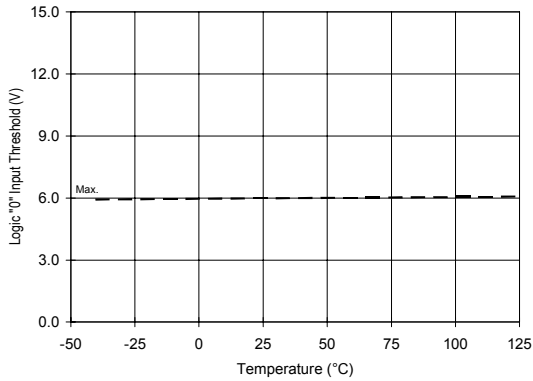

Figure 13A. Logic "0" Input Threshold vs. Temperature

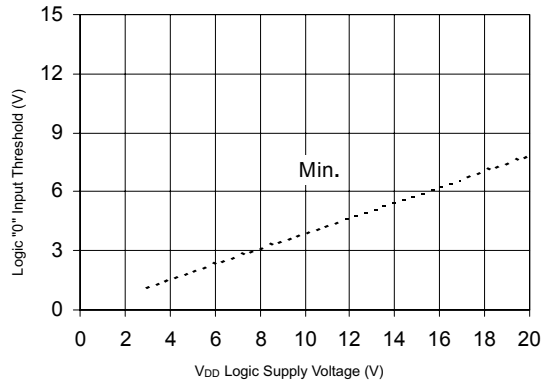

Figure 13B. Logic "0" Input Threshold vs. Voltage

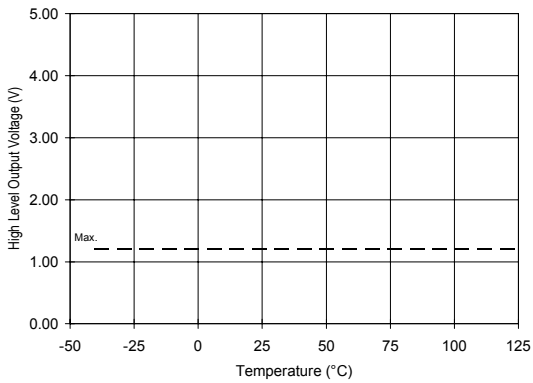

Figure 14A. High Level Output vs. Temperature

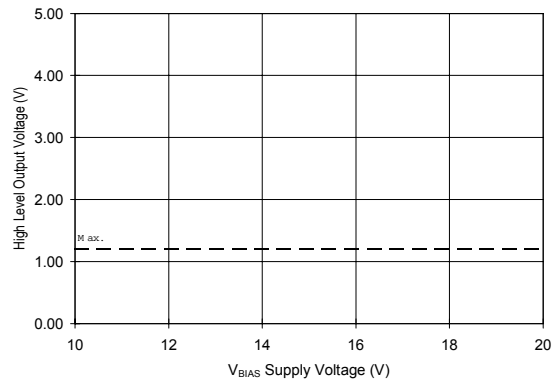

Figure 14B. High Level Output vs. Voltage

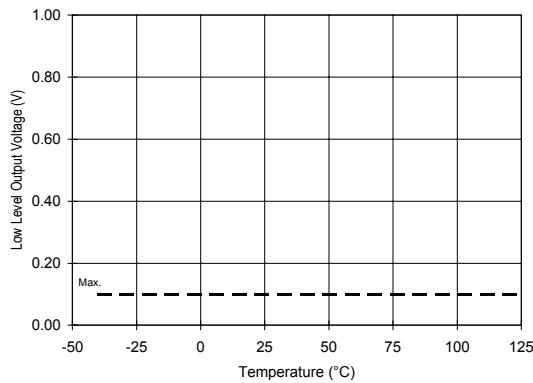

Figure 15A. Low Level Output vs. Temperature

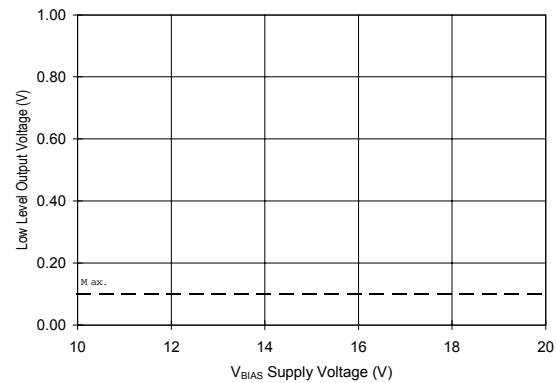

Figure 15B. Low Level Output vs. Voltage

IR2213(S) & (PbF)

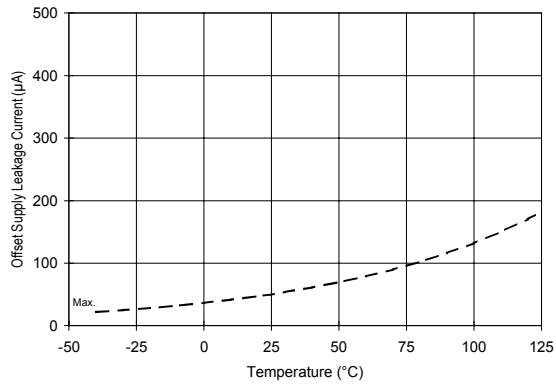

Figure 16A. Offset Supply Current vs. Temperature

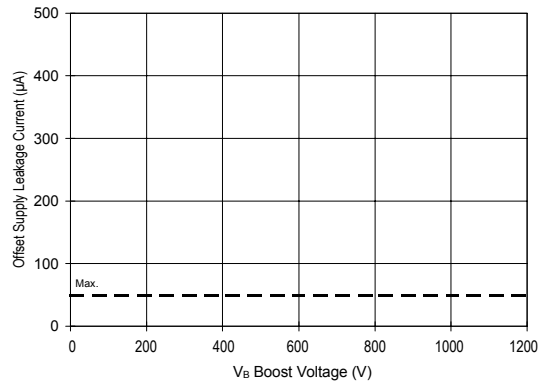

Figure 16B. Offset Supply Current vs. Voltage

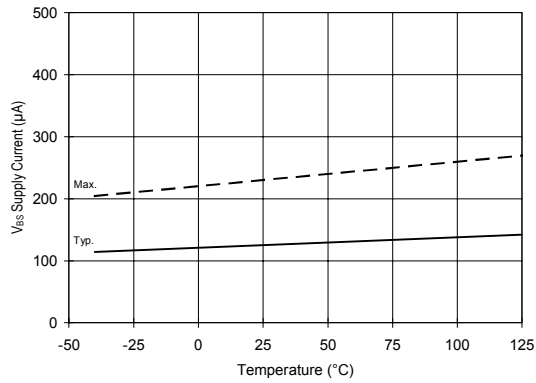

Figure 17A. V_{BS} Supply Current vs. Temperature

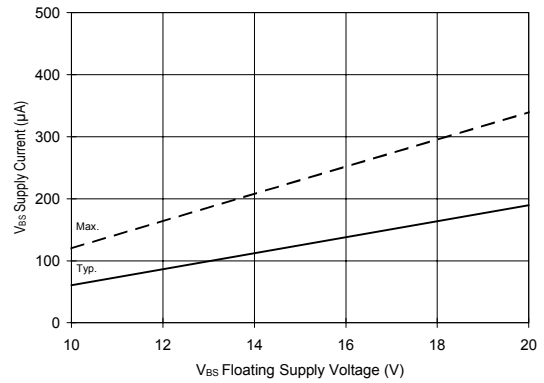

Figure 17B. V_{BS} Supply Current vs. Voltage

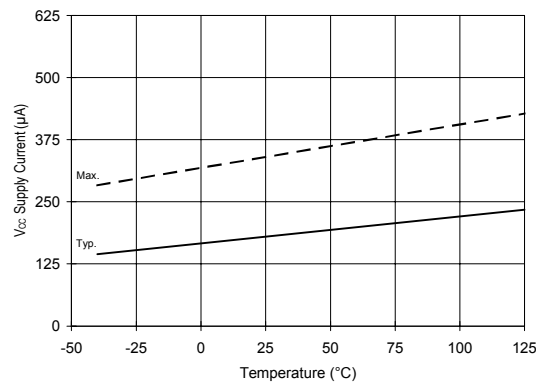

Figure 18A. V_{CC} Supply Current vs. Temperature

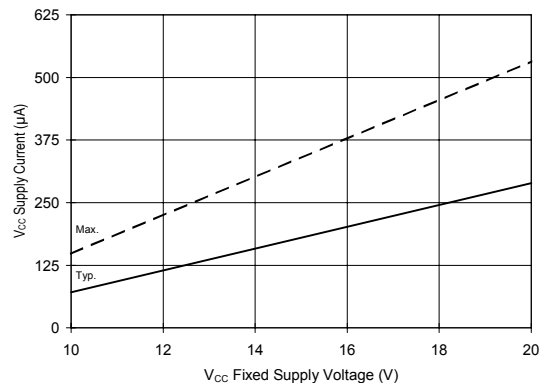

Figure 18B. V_{CC} Supply Current vs. Voltage

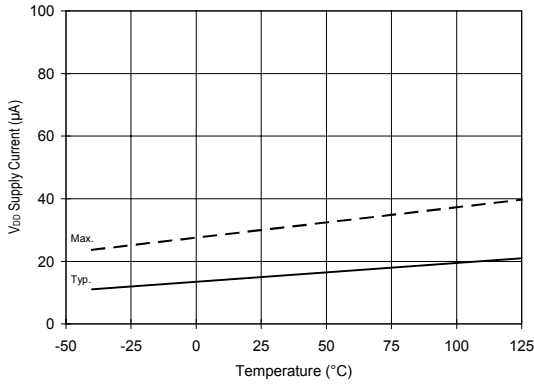

Figure 19A. V_{DD} Supply Current vs. Temperature

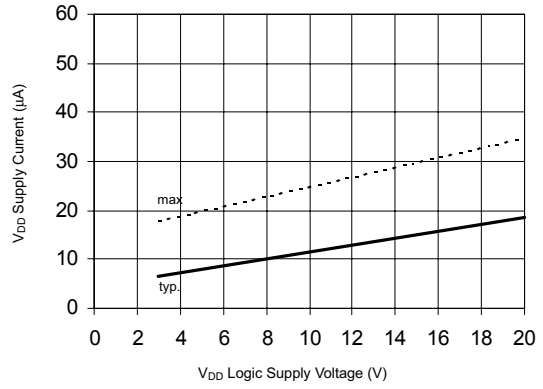

Figure 19B. V_{DD} Supply Current vs. V_{DD} Voltage

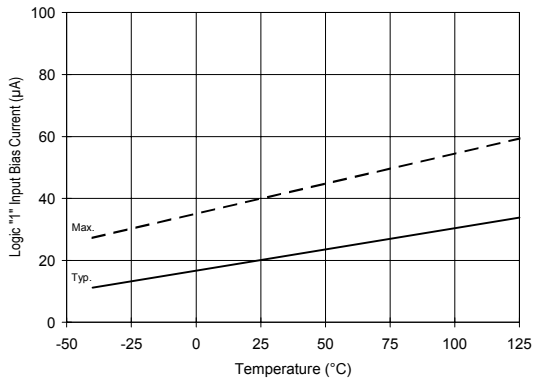

Figure 20A. Logic "1" Input Current vs. Temperature

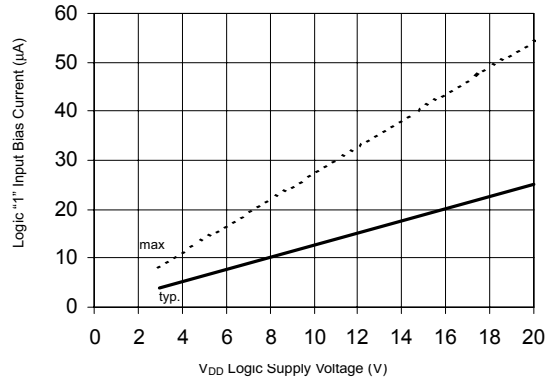

Figure 20B. Logic "1" Input Current vs. V_{DD} Voltage

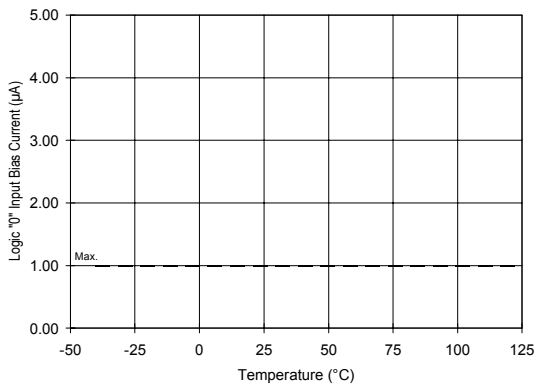

Figure 21A. Logic "0" Input Current vs. Temperature

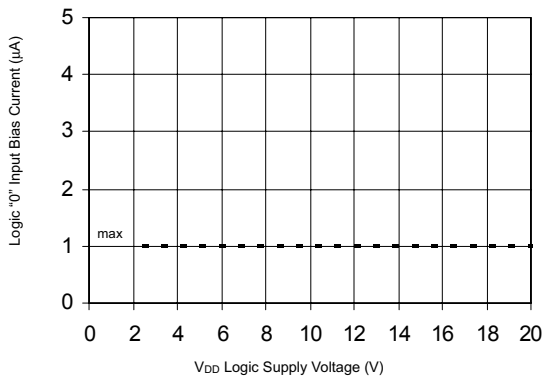

Figure 21B. Logic "0" Input Current vs. V_{DD} Voltage

IR2213(S) & (PbF)

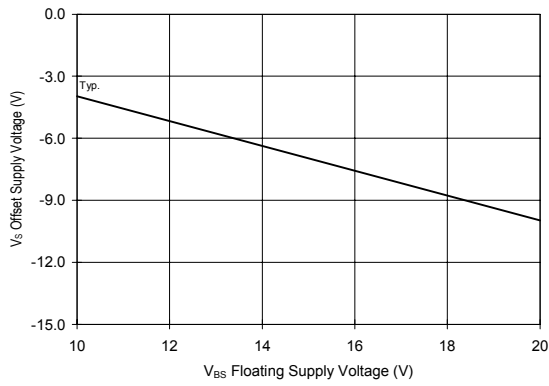

Figure 22. Maximum V_S Negative Offset vs. V_{BS} Supply Voltage

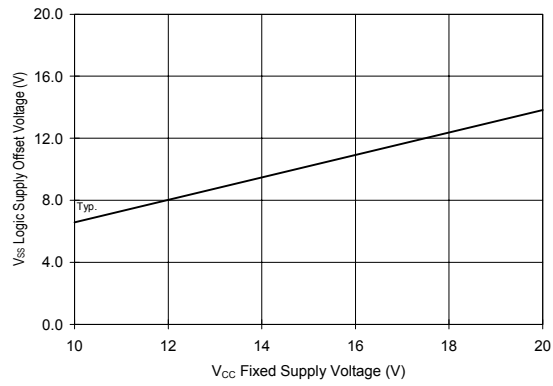

Figure 23. Maximum V_{SS} Positive Offset vs. V_{CC} Supply Voltage

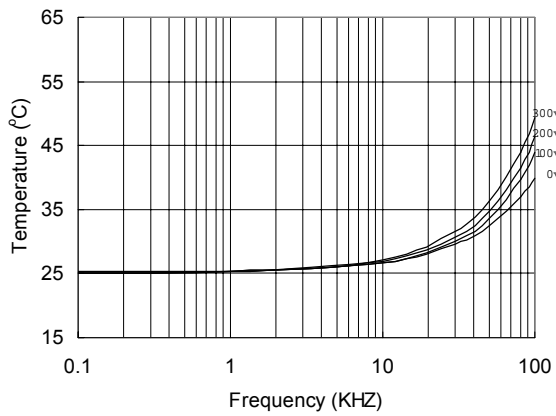

Figure 24. IR2213s vs. Frequency (IRFBC20)
 $R_{gate}=33\Omega, V_{CC}=15V$

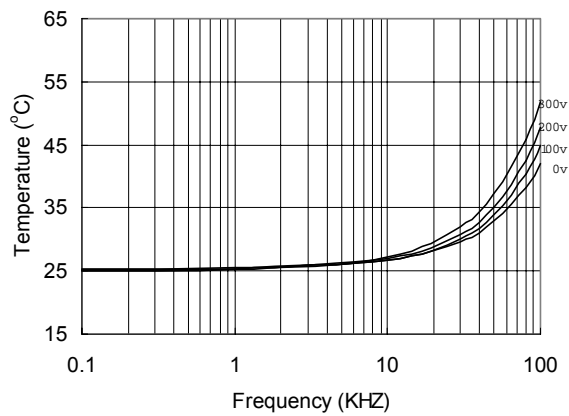

Figure 25. IR2213s vs. Frequency (IRFBC30)
 $R_{gate}=22\Omega, V_{CC}=15V$

IR2213(s) & (PbF)

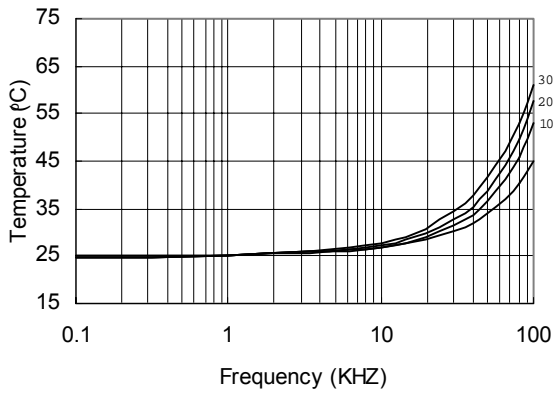

Figure 26. IR2213s vs. Frequency (IRFBC40)
 $R_{gate}=15\Omega, V_{CC}=15V$

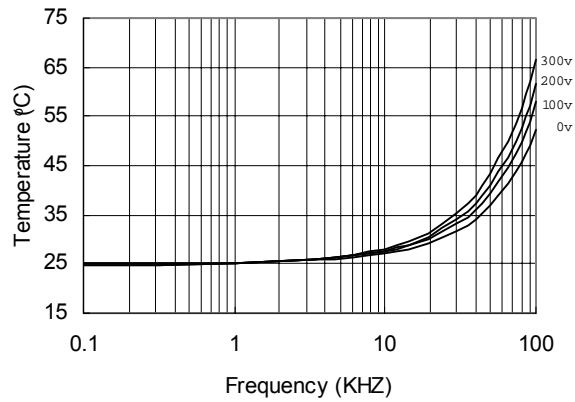

Figure 27. IR2213s vs. Frequency (IRFBC50)
 $R_{gate}=10\Omega, V_{CC}=15V$

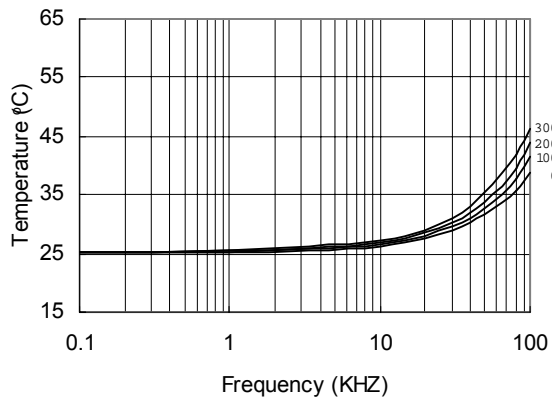

Figure 28. IR2213 vs. Frequency (IRFBC20)
 $R_{gate}=33\Omega, V_{CC}=15V$

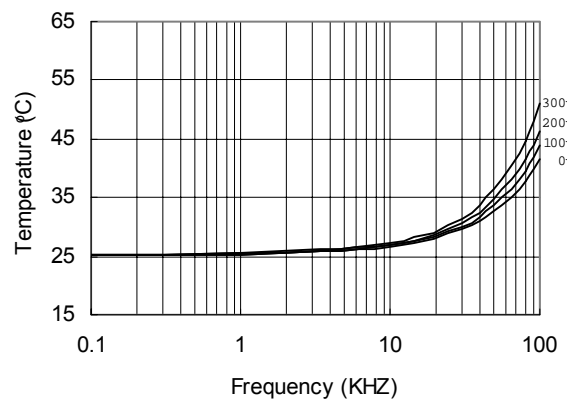

Figure 29. IR2213 vs. Frequency (IRFBC30)
 $R_{gate}=22\Omega, V_{CC}=15V$

IR2213(S) & (PbF)

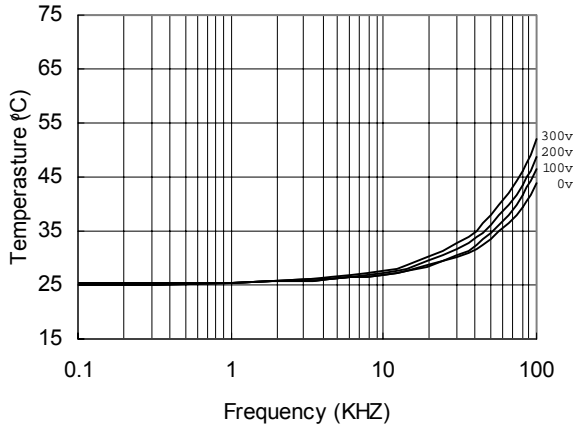

Figure 30. IR2213 vs. Frequency (IRFBC40)
 $R_{gate}=15\Omega, V_{CC}=15V$

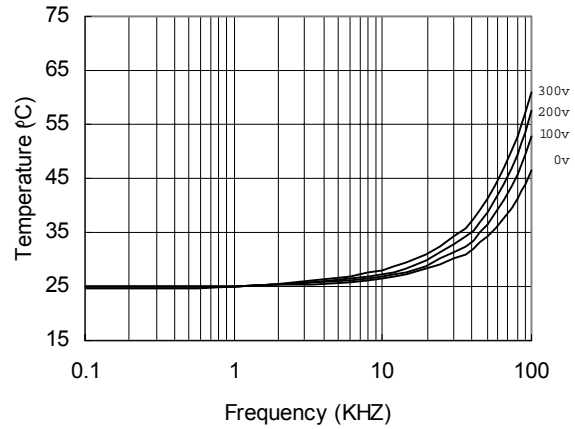
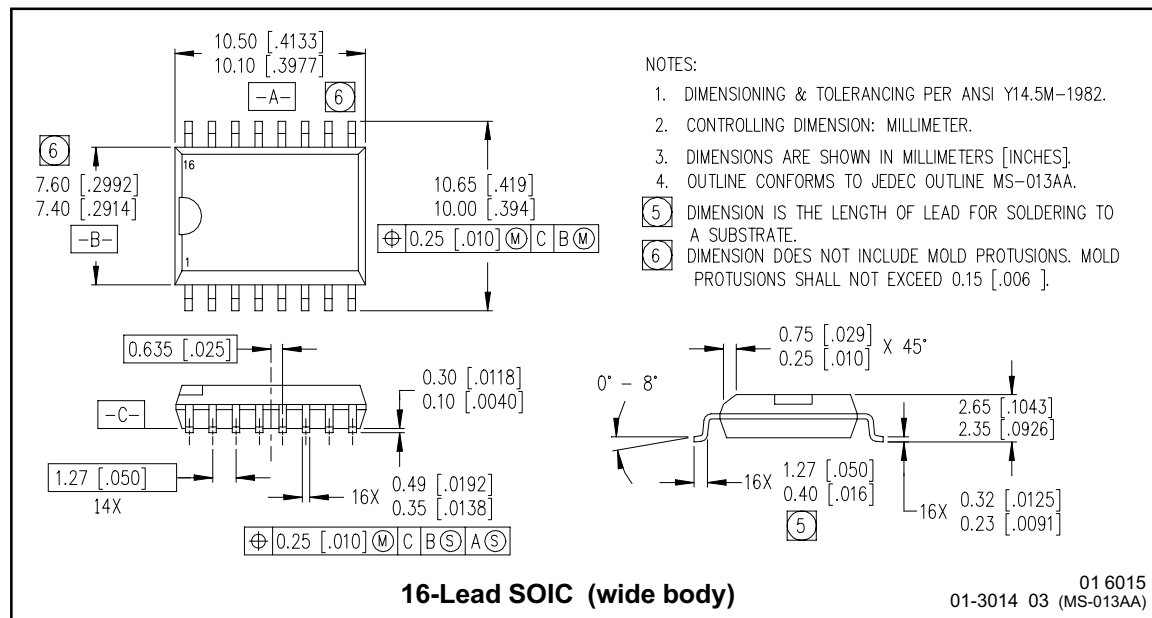
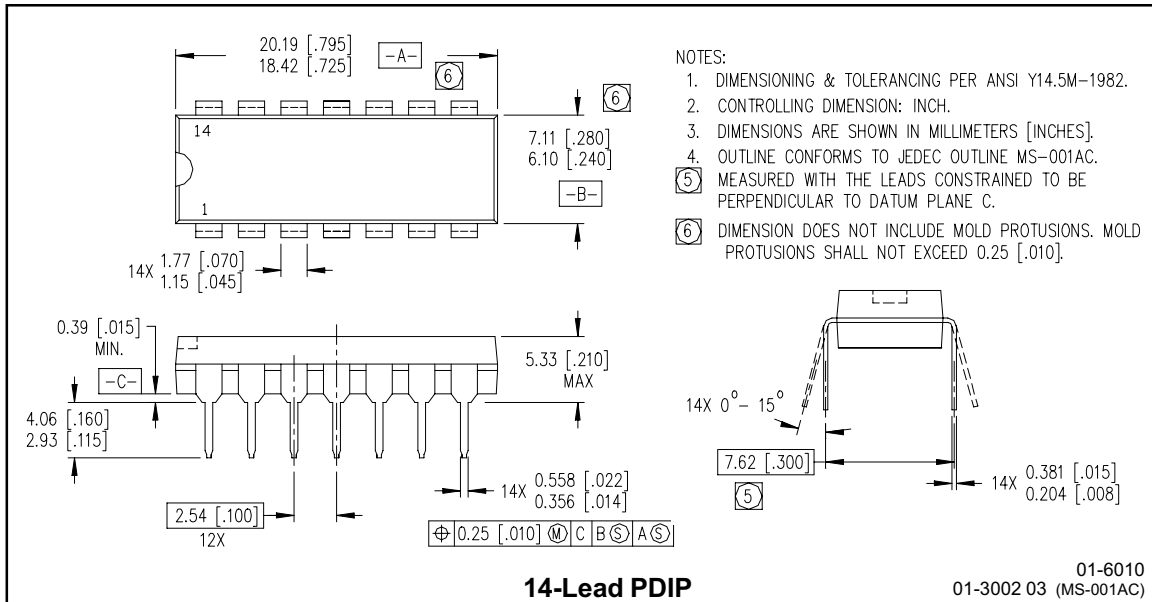

Figure 31. IR213 vs. Frequency (IRFBC50)
 $R_{gate}=10\Omega, V_{CC}=15V$

Case outlines



IR2213(S) & (PbF)

International
IR Rectifier

LEADFREE PART MARKING INFORMATION

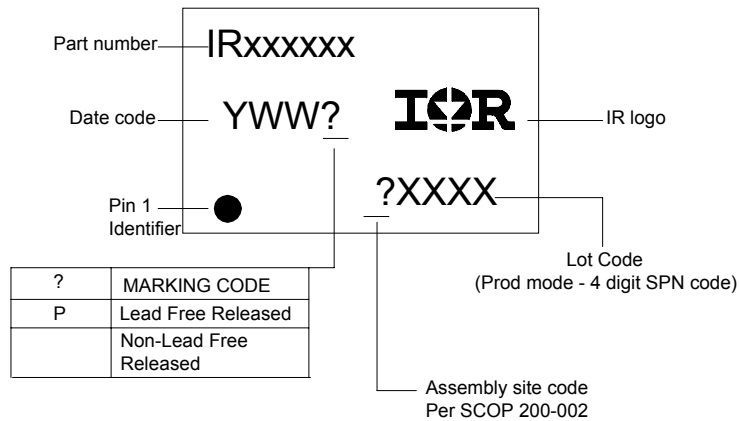

ORDER INFORMATION

Basic Part (Non-Lead Free)

8-Lead PDIP IR2181 order IR2181
 8-Lead SOIC IR2181S order IR2181S
 14-Lead PDIP IR21814 order IR21814
 14-Lead SOIC IR21814 order IR21814S

Leadfree Part

8-Lead PDIP IR2181 order IR2181PbF
 8-Lead SOIC IR2181S order IR2181SPbF
 14-Lead PDIP IR21814 order IR21814PbF
 14-Lead SOIC IR21814 order IR21814SPbF

International
IR Rectifier

This product has been designed and qualified for the industrial market.
 Qualification Standards can be found on IR's Web Site <http://www.irf.com>
 Data and specifications subject to change without notice.

IR WORLD HEADQUARTERS: 233 Kansas St., El Segundo, California 90245 Tel: (310) 252-7105
 9/21/2004