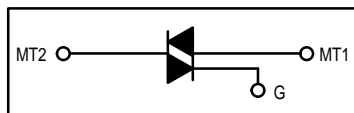


## Triacs

### Silicon Bidirectional Thyristors

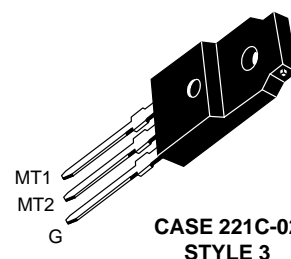
... designed primarily for full-wave ac control applications, such as solid-state relays, motor controls, heating controls and power supplies; or wherever full-wave silicon gate controlled solid-state devices are needed. Triac type thyristors switch from a blocking to a conducting state for either polarity of applied anode voltage with positive or negative gate triggering.

- Blocking Voltage to 800 Volts
- All Diffused and Glass Passivated Junctions for Greater Parameter Uniformity and Stability
- Small, Rugged, Thermowatt Construction for Low Thermal Resistance, High Heat Dissipation and Durability
- Gate Triggering Guaranteed in Four Modes



## MAC15AFP Series

**ISOLATED TRIACs  
THYRISTORS  
15 AMPERES RMS  
400 thru 800 VOLTS**



#### MAXIMUM RATINGS (T<sub>J</sub> = 25°C unless otherwise noted.)

Rating	Symbol	Value	Unit
Repetitive Peak Off-State Voltage <sup>(1)</sup> (T <sub>J</sub> = -40 to +125°C, 1/2 Sine Wave 50 to 60 Hz, Gate Open)	V <sub>DRM</sub>	400 600 800	Volts
On-State RMS Current (T <sub>C</sub> = +80°C) <sup>(2)</sup> Full Cycle Sine Wave 50 to 60 Hz (T <sub>C</sub> = +95°C)	I <sub>T(RMS)</sub>	15 12	Amps
Peak Nonrepetitive Surge Current (One Full Cycle, 60 Hz, T <sub>C</sub> = +80°C) preceded and followed by rated current	I <sub>TSM</sub>	150	Amps
Peak Gate Power (T <sub>C</sub> = +80°C, Pulse Width = 2 μs)	P <sub>GM</sub>	20	Watts
Average Gate Power (T <sub>C</sub> = +80°C, t = 8.3 ms)	P <sub>G(AV)</sub>	0.5	Watt
Peak Gate Current	I <sub>GM</sub>	2	Amps
Peak Gate Voltage	V <sub>GM</sub>	10	Volts
RMS Isolation Voltage (T <sub>A</sub> = 25°C, Relative Humidity ≤ 20%)	V <sub>(ISO)</sub>	1500	Volts
Operating Junction Temperature	T <sub>J</sub>	-40 to +125	°C
Storage Temperature Range	T <sub>stg</sub>	-40 to +150	°C

1. V<sub>DRM</sub> for all types can be applied on a continuous basis. Blocking voltages shall not be tested with a constant current source such that the voltage ratings of the devices are exceeded.
2. The case temperature reference point for all T<sub>C</sub> measurements is a point on the center lead of the package as close as possible to the plastic body.

## MAC15AFP Series

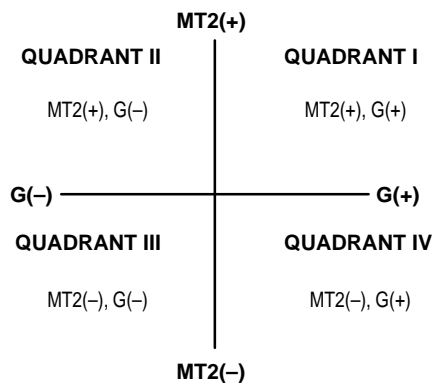
### THERMAL CHARACTERISTICS

Characteristic	Symbol	Max	Unit
Thermal Resistance, Junction to Case	$R_{\theta JC}$	2	$^{\circ}C/W$
Thermal Resistance, Case to Sink	$R_{\theta CS}$	2.2 (typ)	$^{\circ}C/W$
Thermal Resistance, Junction to Ambient	$R_{\theta JA}$	60	$^{\circ}C/W$

### ELECTRICAL CHARACTERISTICS ( $T_C = 25^{\circ}C$ unless otherwise noted.)

Characteristic	Symbol	Min	Typ	Max	Unit
Peak Blocking Current (Either Direction) $T_J = 25^{\circ}C$ ( $V_D = \text{Rated } V_{DRM}$ , $T_J = 125^{\circ}C$ , Gate Open)	$I_{DRM}$	—	—	10 2	$\mu A$ mA
Peak On-State Voltage (Either Direction) ( $I_{TM} = 21$ A Peak; Pulse Width = 1 to 2 ms, Duty Cycle $\leq 2\%$ )	$V_{TM}$	—	1.3	1.6	Volts
Gate Trigger Current (Continuous dc) (Main Terminal Voltage = 12 Vdc, $R_L = 100$ Ohms)	$I_{GT}$				mA
MT2(+), G(+)		—	—	50	
MT2(+), G(-)		—	—	50	
MT2(-), G(-)		—	—	50	
MT2(-), G(+)		—	—	75	
Gate Trigger Voltage (Continuous dc) (Main Terminal Voltage = 12 Vdc, $R_L = 100$ Ohms)	$V_{GT}$				Volts
MT2(+), G(+)		—	0.9	2	
MT2(+), G(-)		—	0.9	2	
MT2(-), G(-)		—	1.1	2	
MT2(-), G(+)		—	1.4	2.5	
(Main Terminal Voltage = Rated $V_{DRM}$ , $R_L = 10$ k $\Omega$ , $T_J = +110^{\circ}C$ )					
MT2(+), G(+); MT2(-), G(-); MT2(+), G(-); MT2(-), G(+)		0.2 0.2	— —	— —	
Holding Current (Either Direction) (Main Terminal Voltage = 12 Vdc, Gate Open, Initiating Current = 200 mA)	$I_H$	—	6	40	mA
Turn-On Time ( $V_D = \text{Rated } V_{DRM}$ , $I_{TM} = 17$ A, $I_{GT} = 120$ mA, Rise Time = 0.1 $\mu s$ , Pulse Width = 2 $\mu s$ )	$t_{gt}$	—	1.5	—	$\mu s$
Critical Rate of Rise of Commutation Voltage ( $V_D = \text{Rated } V_{DRM}$ , $I_{TM} = 21$ A, Commutating $di/dt = 7.6$ A/ms, Gate Unenergized, $T_C = 80^{\circ}C$ )	$dv/dt(c)$	—	5	—	V/ $\mu s$

### QUADRANT DEFINITIONS



Trigger devices are recommended for gating on Triacs. They provide:

1. Consistent predictable turn-on points.
2. Simplified circuitry.
3. Fast turn-on time for cooler, more efficient and reliable operation.

### ELECTRICAL CHARACTERISTICS of RECOMMENDED BIDIRECTIONAL SWITCHES

Usage	General	
	MBS4991	MBS4992
Part Number	MBS4991	MBS4992
$V_S$	6–10 V	7.5–9 V
$I_S$	350 $\mu A$ Max	120 $\mu A$ Max
$V_{S1}-V_{S2}$	0.5 V Max	0.2 V Max
Temperature Coefficient	0.02%/ $^{\circ}C$ Typ	

1. Ratings apply for open gate conditions. Thyristor devices shall not be tested with a constant current source for blocking capability such that the voltage applied exceeds the rated blocking voltage.

TYPICAL CHARACTERISTICS

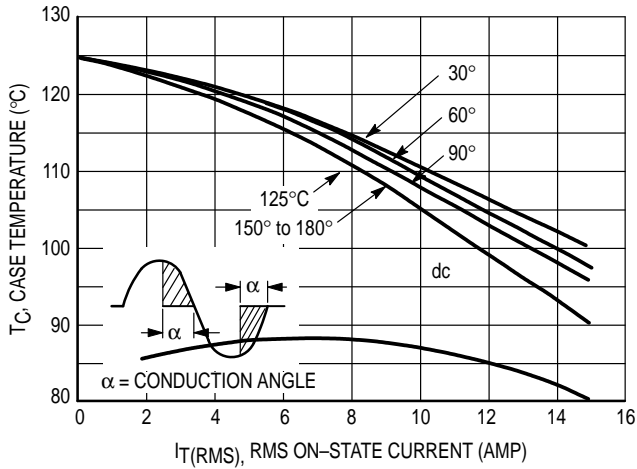


Figure 1. RMS Current Derating

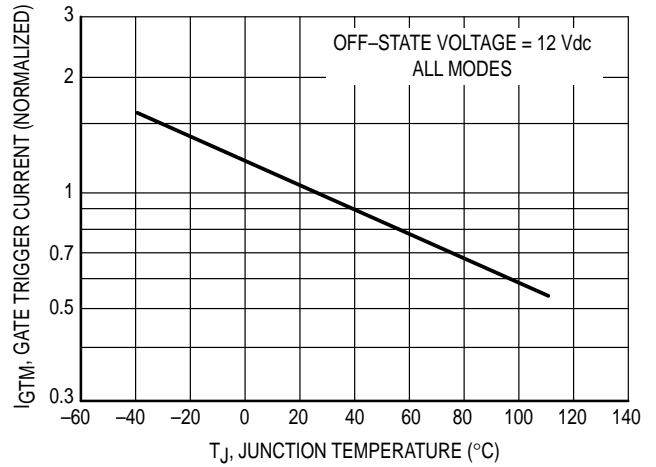


Figure 4. Typical Gate Trigger Current

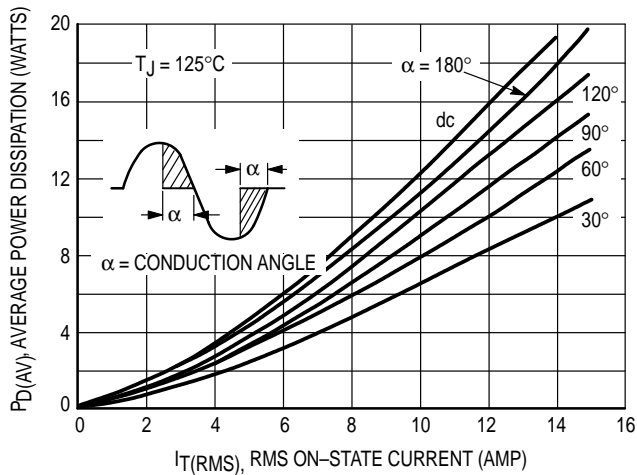


Figure 2. On-State Power Dissipation

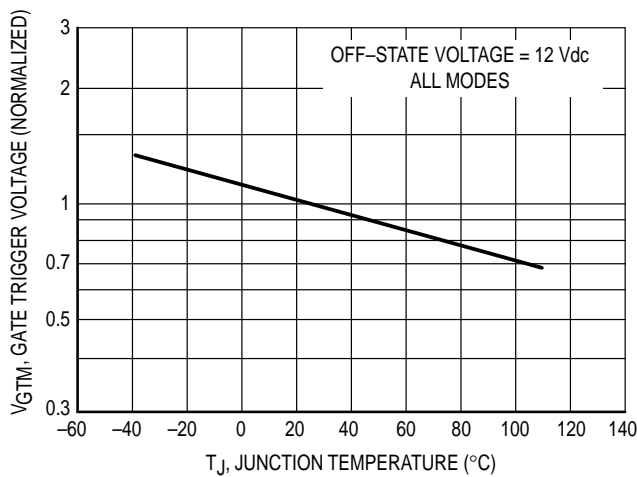


Figure 3. Typical Gate Trigger Voltage

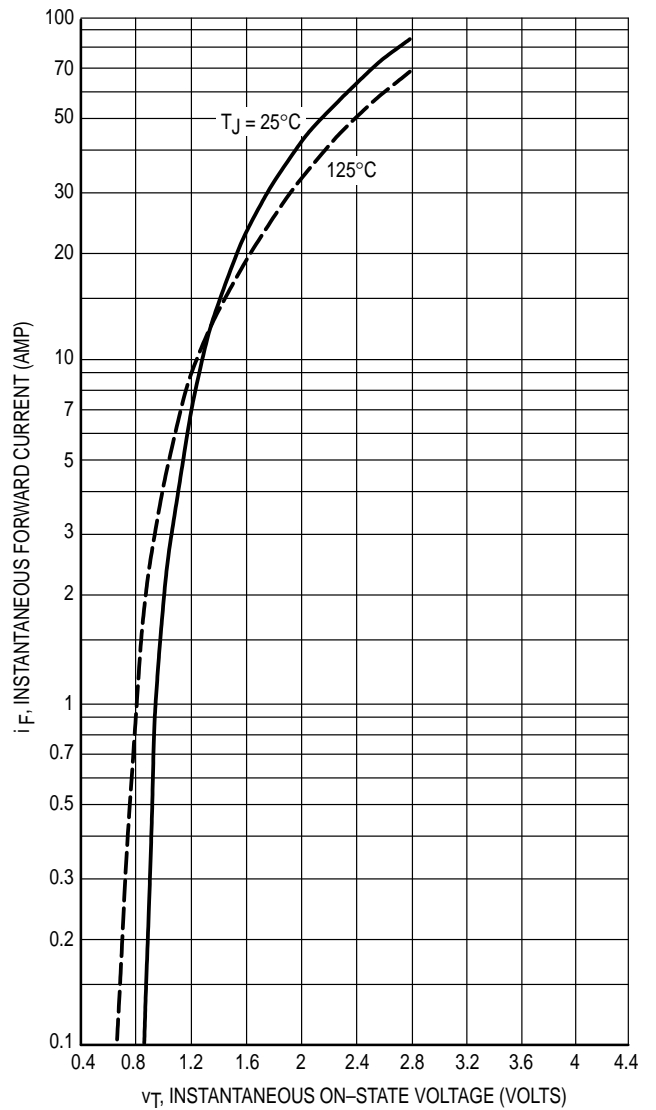
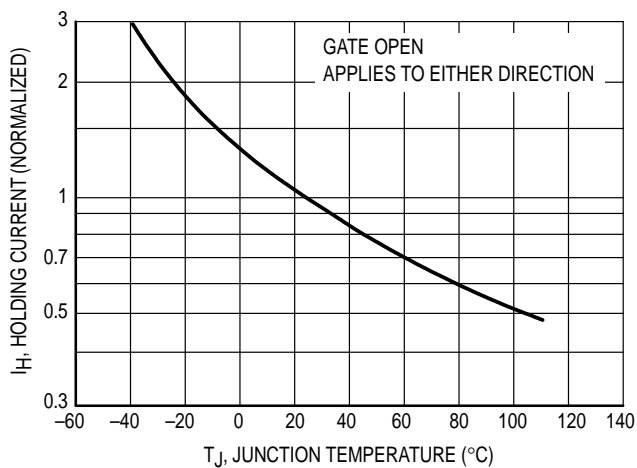
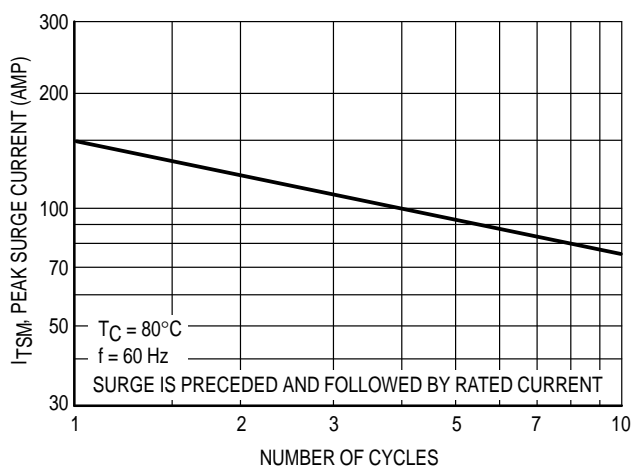


Figure 5. Maximum On-State Characteristics

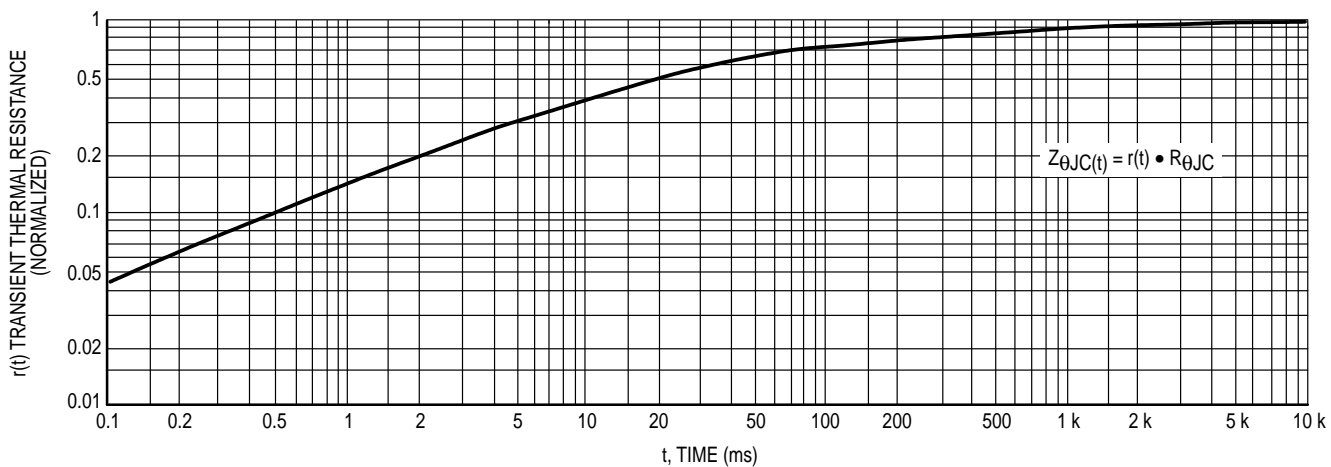
**MAC15AFP Series**



**Figure 6. Typical Holding Current**

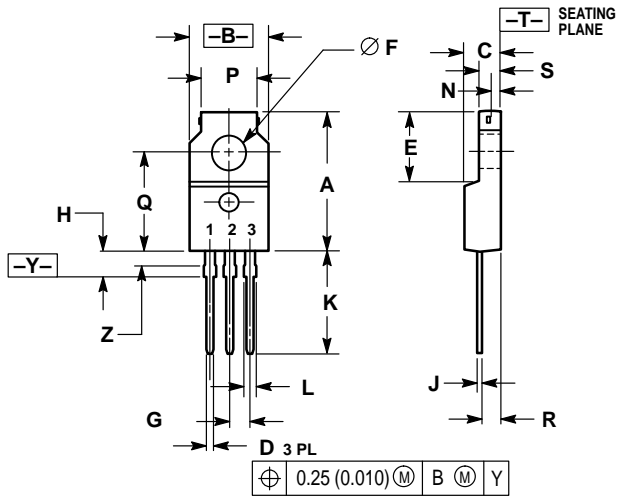


**Figure 7. Maximum Nonrepetitive Surge Current**



**Figure 8. Thermal Response**

PACKAGE DIMENSIONS



STYLE 3:  
 PIN 1. MT 1  
 2. MT 2  
 3. GATE


NOTES:

1. DIMENSIONING AND TOLERANCING PER ANSI Y14.5M, 1982.
2. CONTROLLING DIMENSION: INCH.
3. LEAD DIMENSIONS UNCONTROLLED WITHIN DIMENSION Z.

DIM	INCHES		MILLIMETERS	
	MIN	MAX	MIN	MAX
A	0.680	0.700	17.28	17.78
B	0.388	0.408	9.86	10.36
C	0.175	0.195	4.45	4.95
D	0.025	0.040	0.64	1.01
E	0.340	0.355	8.64	9.01
F	0.140	0.150	3.56	3.81
G	0.100 BSC		2.54 BSC	
H	0.110	0.155	2.80	3.93
J	0.018	0.028	0.46	0.71
K	0.500	0.550	12.70	13.97
L	0.045	0.070	1.15	1.77
N	0.049	—	1.25	—
P	0.270	0.290	6.86	7.36
Q	0.480	0.500	12.20	12.70
R	0.090	0.120	2.29	3.04
S	0.105	0.115	2.67	2.92
Z	0.070	0.090	1.78	2.28

CASE 221C-02  
 ISSUE B

# NOTES

Motorola reserves the right to make changes without further notice to any products herein. Motorola makes no warranty, representation or guarantee regarding the suitability of its products for any particular purpose, nor does Motorola assume any liability arising out of the application or use of any product or circuit, and specifically disclaims any and all liability, including without limitation consequential or incidental damages. "Typical" parameters which may be provided in Motorola data sheets and/or specifications can and do vary in different applications and actual performance may vary over time. All operating parameters, including "Typicals" must be validated for each customer application by customer's technical experts. Motorola does not convey any license under its patent rights nor the rights of others. Motorola products are not designed, intended, or authorized for use as components in systems intended for surgical implant into the body, or other applications intended to support or sustain life, or for any other application in which the failure of the Motorola product could create a situation where personal injury or death may occur. Should Buyer purchase or use Motorola products for any such unintended or unauthorized application, Buyer shall indemnify and hold Motorola and its officers, employees, subsidiaries, affiliates, and distributors harmless against all claims, costs, damages, and expenses, and reasonable attorney fees arising out of, directly or indirectly, any claim of personal injury or death associated with such unintended or unauthorized use, even if such claim alleges that Motorola was negligent regarding the design or manufacture of the part. Motorola and  are registered trademarks of Motorola, Inc. Motorola, Inc. is an Equal Opportunity/Affirmative Action Employer.

## MAC15AFP Series

Mfax is a trademark of Motorola, Inc.

**How to reach us:**

**USA/EUROPE/Locations Not Listed:** Motorola Literature Distribution;  
P.O. Box 5405, Denver, Colorado 80217. 1-303-675-2140 or 1-800-441-2447

**JAPAN:** Motorola Japan Ltd.; SPD, Strategic Planning Office, 141,  
4-32-1 Nishi-Gotanda, Shinagawa-ku, Tokyo, Japan. 81-3-5487-8488

**Customer Focus Center: 1-800-521-6274**

**Mfax™:** RMFAX0@email.sps.mot.com – TOUCHTONE 1-602-244-6609  
Motorola Fax Back System – US & Canada ONLY 1-800-774-1848  
– <http://sps.motorola.com/mfax/>

**ASIA/PACIFIC:** Motorola Semiconductors H.K. Ltd.; Silicon Harbour Centre,  
2, Dai King Street, Tai Po Industrial Estate, Tai Po, N.T., Hong Kong.  
852-26629298

**HOME PAGE:** <http://motorola.com/sps/>



**MOTOROLA**



---

MAC15A6FP/D