

TRIACS

Silicon Bidirectional Thyristors

Designed for high performance full-wave ac control applications where high noise immunity and high commutating di/dt are required.

- Blocking Voltage to 800 Volts
- On-State Current Rating of 15 Amperes RMS at 80°C
- Uniform Gate Trigger Currents in Three Modes
- High Immunity to dv/dt — 250 V/μs minimum at 125°C
- Minimizes Snubber Networks for Protection
- Industry Standard TO-220AB Package
- High Commutating di/dt — 9.0 A/ms minimum at 125°C

MAC15 SERIES*

*Motorola preferred devices

TRIACS
15 AMPERES RMS
600 thru 800
VOLTS

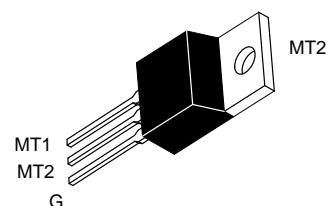
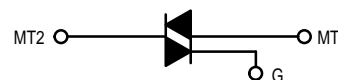

CASE 221A-09
(TO-220AB)
Style 4

MAXIMUM RATINGS (T_J = 25°C unless otherwise noted)

Symbol	Parameter	Value	Unit
V _{DRM}	Peak Repetitive Off-State Voltage (1) (-40 to 125°C, Sine Wave, 50 to 60 Hz, Gate Open)	MAC15M MAC15N 600 800	Volts
I _{T(RMS)}	On-State RMS Current (60 Hz, T _C = 80°C)	15	A
I _{TSM}	Peak Non-repetitive Surge Current (One Full Cycle, 60 Hz, T _J = 125°C)	150	A
i ² t	Circuit Fusing Consideration (t = 8.3 ms)	93	A ² sec
P _{GM}	Peak Gate Power (Pulse Width ≤ 1.0 μs, T _C = 80°C)	20	Watts
P _{G(AV)}	Average Gate Power (t = 8.3 ms, T _C = 80°C)	0.5	Watts
T _J	Operating Junction Temperature Range	-40 to +125	°C
T _{stg}	Storage Temperature Range	-40 to +150	°C

THERMAL CHARACTERISTICS

R _{θJC} R _{θJA}	Thermal Resistance — Junction to Case — Junction to Ambient	2.0 62.5	°C/W
T _L	Maximum Lead Temperature for Soldering Purposes 1/8" from Case for 10 Seconds	260	°C

(1) V_{DRM} for all types can be applied on a continuous basis. Blocking voltages shall not be tested with a constant current source such that the voltage ratings of the devices are exceeded.

Preferred devices are Motorola recommended choices for future use and best overall value.

MAC15 SERIES

ELECTRICAL CHARACTERISTICS (T_J = 25°C unless otherwise noted)

Symbol	Characteristic	Min	Typ	Max	Unit	
OFF CHARACTERISTICS						
I _{DRM}	Peak Repetitive Blocking Current (V _D = Rated V _{DRM} , Gate Open)	T _J = 25°C	—	—	0.01	mA
		T _J = 125°C	—	—	2.0	

ON CHARACTERISTICS

V _{TM}	Peak On-State Voltage* (I _{TM} = ±21 A Peak)	—	1.2	1.6	Volts
I _{GT}	Continuous Gate Trigger Current (V _D = 12 V, R _L = 100 Ω) MT2(+), G(+) MT2(+), G(-) MT2(-), G(-)	5.0	13	35	mA
		5.0	16	35	
		5.0	18	35	
I _H	Hold Current (V _D = 12 V, Gate Open, Initiating Current = ±150 mA)	—	20	40	mA
I _L	Latch Current (V _D = 24 V, I _G = 35 mA) MT2(+), G(+) MT2(+), G(-) MT2(-), G(-)	—	33	50	mA
		—	36	80	
		—	33	50	
V _{GT}	Gate Trigger Voltage (V _D = 12 V, R _L = 100 Ω) MT2(+), G(+) MT2(+), G(-) MT2(-), G(-)	0.5	0.75	1.5	Volts
		0.5	0.72	1.5	
		0.5	0.82	1.5	

DYNAMIC CHARACTERISTICS

(di/dt) _C	Rate of Change of Commutating Current* See Figure 10. (V _D = 400 V, I _{TM} = 6.0 A, Commutating dv/dt = 24 V/μs, Gate Open, T _J = 125°C, f = 250 Hz, No Snubber)	9.0	—	—	A/ms
dv/dt	Critical Rate of Rise of Off-State Voltage (V _D = Rated V _{DRM} , Exponential Waveform, Gate Open, T _J = 125°C)	250	—	—	V/μs

*Indicates Pulse Test: Pulse Width ≤ 2.0 ms, Duty Cycle ≤ 2%.

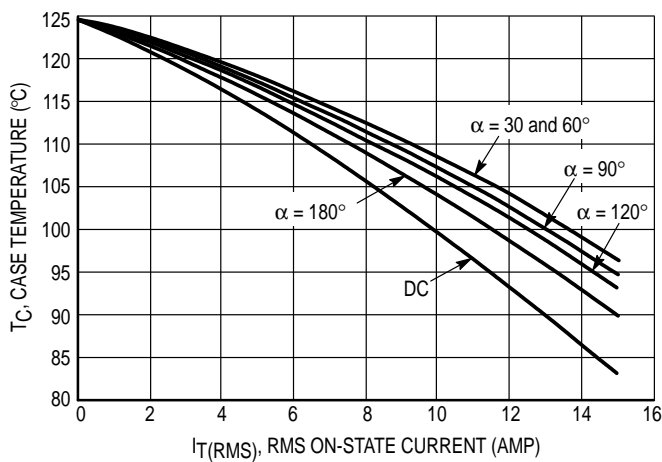

Figure 1. RMS Current Derating

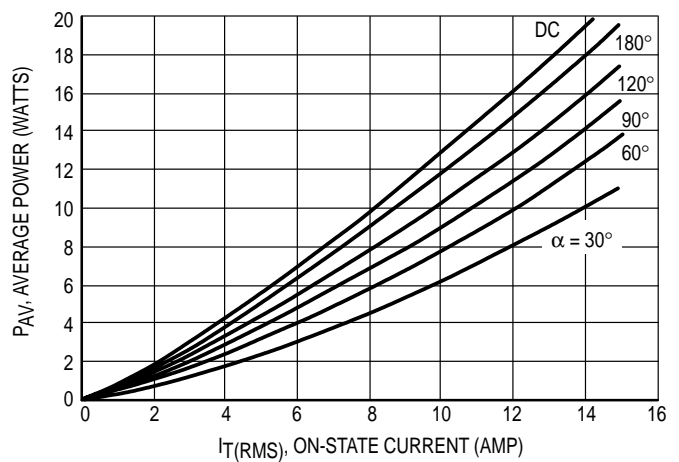

Figure 2. On-State Power Dissipation

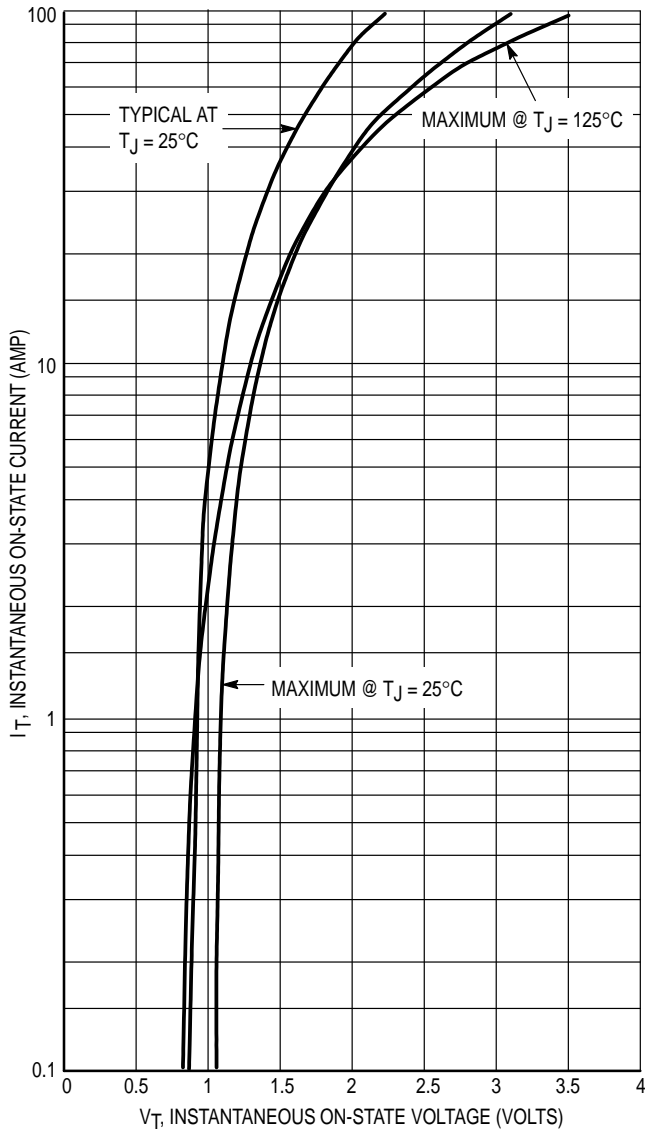

Figure 3. On-State Characteristics

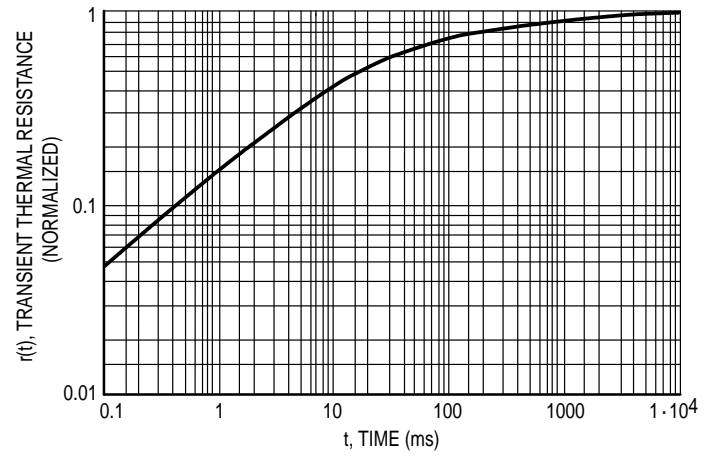

Figure 4. Thermal Response

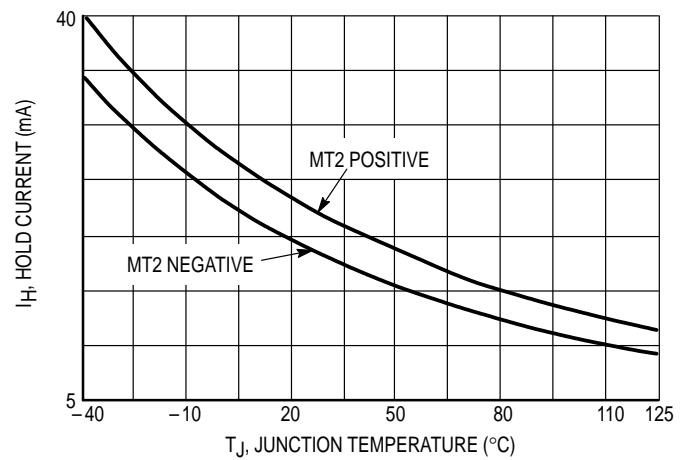

Figure 5. Hold Current Variation

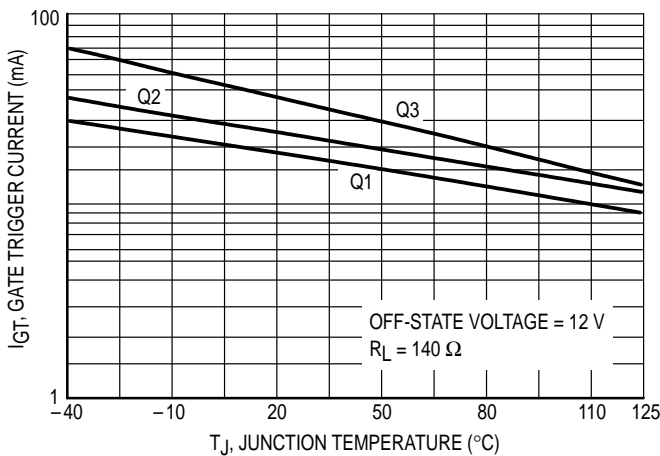

Figure 6. Gate Trigger Current Variation

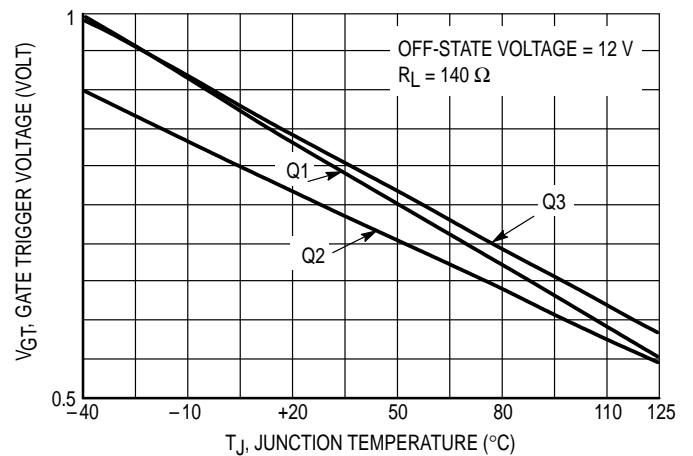

Figure 7. Gate Trigger Voltage Variation

MAC15 SERIES

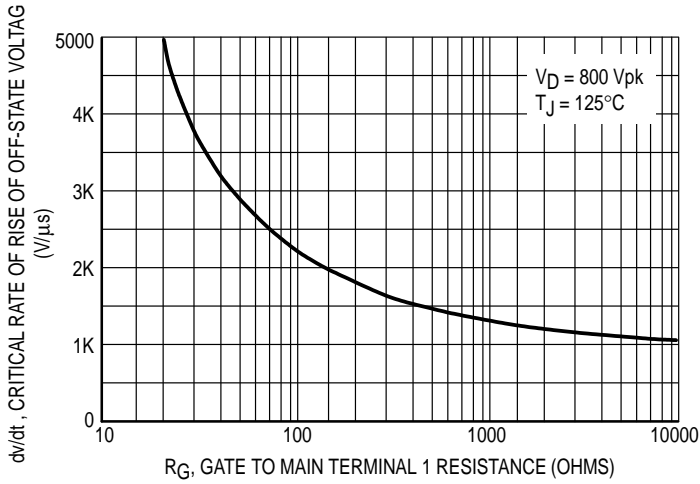

Figure 8. Critical Rate of Rise of Off-State Voltage (Exponential)

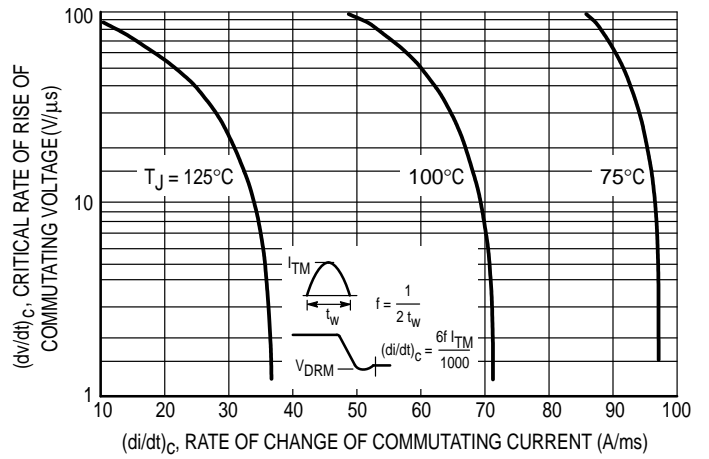
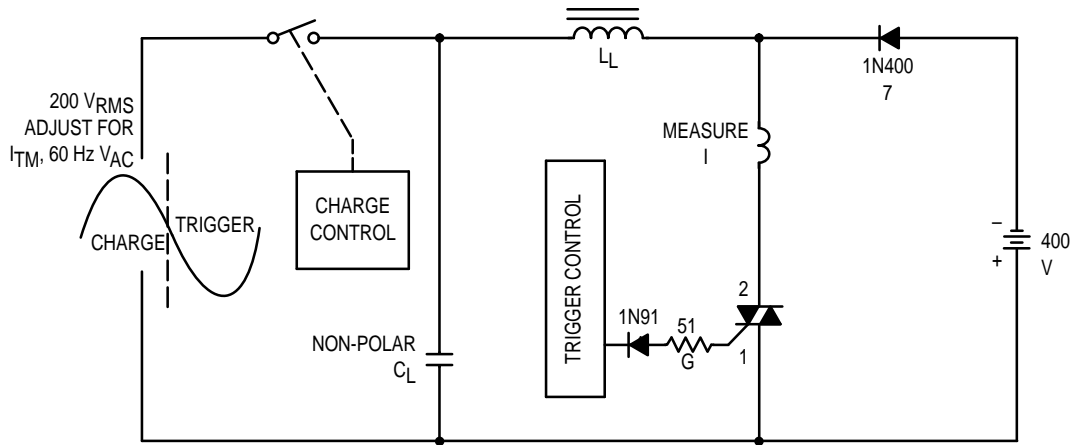

Figure 9. Critical Rate of Rise of Commutating Voltage



Note: Component values are for verification of rated $(dv/dt)_c$. See AN1048 for additional information.

Figure 10. Simplified Test Circuit to Measure the Critical Rate of Rise of Commutating Voltage

PACKAGE DIMENSIONS

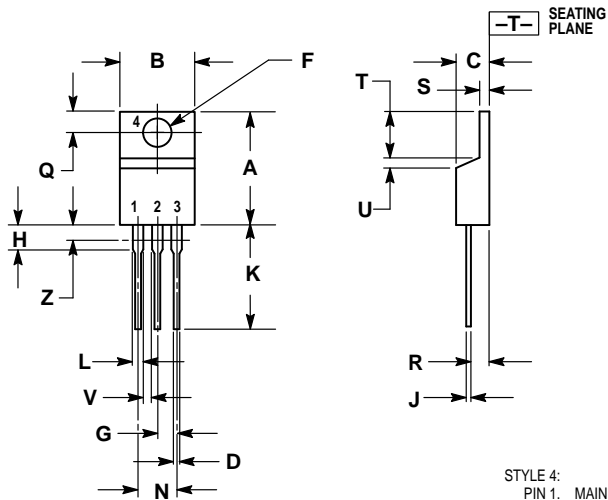

STYLE 4:
 PIN 1. MAIN TERMINAL 1
 2. MAIN TERMINAL 2
 3. GATE
 4. MAIN TERMINAL 2

- NOTES:
 1. DIMENSIONING AND TOLERANCING PER ANSI Y14.5M, 1982.
 2. CONTROLLING DIMENSION: INCH.
 3. DIMENSION Z DEFINES A ZONE WHERE ALL BODY AND LEAD IRREGULARITIES ARE ALLOWED.

DIM	INCHES		MILLIMETERS	
	MIN	MAX	MIN	MAX
A	0.570	0.620	14.48	15.75
B	0.380	0.405	9.66	10.28
C	0.160	0.190	4.07	4.82
D	0.025	0.035	0.64	0.88
F	0.142	0.147	3.61	3.73
G	0.095	0.105	2.42	2.66
H	0.110	0.155	2.80	3.93
J	0.018	0.025	0.46	0.64
K	0.500	0.562	12.70	14.27
L	0.045	0.060	1.15	1.52
N	0.190	0.210	4.83	5.33
Q	0.100	0.120	2.54	3.04
R	0.080	0.110	2.04	2.79
S	0.045	0.055	1.15	1.39
T	0.235	0.255	5.97	6.47
U	0.000	0.050	0.00	1.27
V	0.045	—	1.15	—
Z	—	0.080	—	2.04

CASE 221A-09
 (TO-220AB)
 ISSUE Z

NOTES

Motorola reserves the right to make changes without further notice to any products herein. Motorola makes no warranty, representation or guarantee regarding the suitability of its products for any particular purpose, nor does Motorola assume any liability arising out of the application or use of any product or circuit, and specifically disclaims any and all liability, including without limitation consequential or incidental damages. "Typical" parameters which may be provided in Motorola data sheets and/or specifications can and do vary in different applications and actual performance may vary over time. All operating parameters, including "Typicals" must be validated for each customer application by customer's technical experts. Motorola does not convey any license under its patent rights nor the rights of others. Motorola products are not designed, intended, or authorized for use as components in systems intended for surgical implant into the body, or other applications intended to support or sustain life, or for any other application in which the failure of the Motorola product could create a situation where personal injury or death may occur. Should Buyer purchase or use Motorola products for any such unintended or unauthorized application, Buyer shall indemnify and hold Motorola and its officers, employees, subsidiaries, affiliates, and distributors harmless against all claims, costs, damages, and expenses, and reasonable attorney fees arising out of, directly or indirectly, any claim of personal injury or death associated with such unintended or unauthorized use, even if such claim alleges that Motorola was negligent regarding the design or manufacture of the part. Motorola and  are registered trademarks of Motorola, Inc. Motorola, Inc. is an Equal Opportunity/Affirmative Action Employer.

MAC15 SERIES

Mfax is a trademark of Motorola, Inc.

How to reach us:

USA/EUROPE/Locations Not Listed: Motorola Literature Distribution;
P.O. Box 5405, Denver, Colorado 80217. 1-303-675-2140 or 1-800-441-2447

JAPAN: Motorola Japan Ltd.; SPD, Strategic Planning Office, 141,
4-32-1 Nishi-Gotanda, Shinagawa-ku, Tokyo, Japan. 81-3-5487-8488

Customer Focus Center: 1-800-521-6274

Mfax™: RMFAX0@email.sps.mot.com – TOUCHTONE 1-602-244-6609
Motorola Fax Back System – US & Canada ONLY 1-800-774-1848
– <http://sps.motorola.com/mfax/>

ASIA/PACIFIC: Motorola Semiconductors H.K. Ltd.; Silicon Harbour Centre,
2, Dai King Street, Tai Po Industrial Estate, Tai Po, N.T., Hong Kong.
852-26629298

HOME PAGE: <http://motorola.com/sps/>



MOTOROLA



MAC15M/D