



C-MOS COMPARATOR WITH OPEN DRAIN OUTPUT

■ GENERAL DESCRIPTION

The NJU7112A and 14A dual and quad C-MOS Comparators performing wide operating voltage from 3 to 16V, low operating current and low offset voltage.

The NJU7112A and 14A operated on a single-power-supply can interface with most of TTL and C-MOS type standard logic ICs.

■ FEATURES

- Single-Power-Supply
- Wide Operating Voltage ($V_{DD}=3\sim 16V$)
- Low Operating Current ($11\mu A$ / circuit typ.)
- Wide Common Mode Input Voltage ($0\sim 3.8V$ at $V_{DD}=5V$)
- High Input Impedance
- Low Bias Current ($I_{IB}=1pA$)
- Low Offset Voltage
- Open Drain Output
- Package Outline
DIP/DMP 8 (NJU7112A)
DIP/DMP 14 (NJU7114A)
- C-MOS Technology

■ PACKAGE OUTLINE

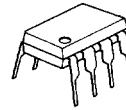

NJU7112AD



NJU7112AM

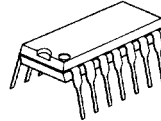

NJU7114AD

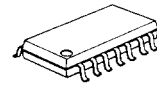

NJU7114AM

■ EQUIVALENT CIRCUIT

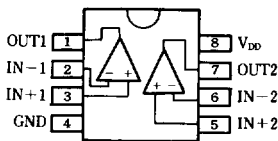

NJU7112AD/AM

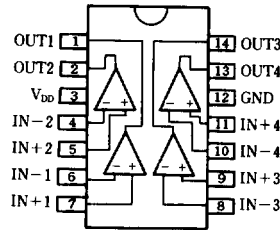

NJU7114AD/AM

■ PIN CONFIGURATION

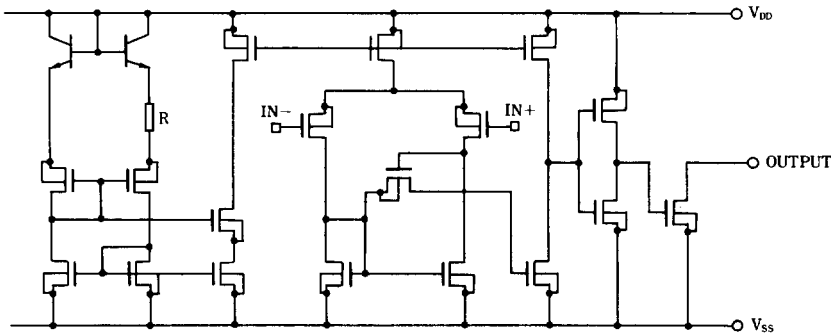

5



■ ABSOLUTE MAXIMUM RATINGS

(Ta=25°C)

PARAMETER	SYMBOL	RATINGS	UNIT
Supply Voltage	V _{DD}	18	V
Differential Input Voltage	V _{ID}	± 18 (Note1)	V
Input Voltage	V _I	18	V
Output Voltage	V _O	18	V
Output Current	I _O	20	mA
Power Dissipation	P _D	(DIP8) 500 (DIP14) 700 (DMP8) 300 (DMP14) 300	mW
Operating Temperature	T _{opr}	0 ~ +70	°C
Storage Temperature	T _{stg}	-40 ~ +125	°C

(Note1) If the supply voltage (V_{DD}) is less than 18V, the input voltage must not over the V_{DD} level though 18V is limit specified.

■ ELECTRICAL CHARACTERISTICS

(Ta=25°C, V_{DD}=5V)

PARAMETER	SYMBOL	CONDITIONS	NJU7112A			NJU7114A			UNIT
			MIN	TYP	MAX	MIN	TYP	MAX	
Operating Voltage	V _{DD}		3	—	16	3	—	16	V
Input Offset Voltage	V _{IO}	V _{IC} =V _{ICmin} (Note2)	—	1.4	12	—	1.4	12	mV
Input Offset Current	I _{IO}		—	1	—	—	1	—	pA
Input Bias Current	I _{IB}		—	1	—	—	1	—	pA
Input Common Mode Voltage Range	V _{ICM}		0	—	3.8	0	—	3.8	V
Output Voltage	V _{OH}	V _{ID} =+1V, I _{OH} =+5V	—	2	40	—	2	40	V
	V _{OL}	V _{ID} =+1V, I _{OL} =+6mA	—	0.35	0.40	—	0.35	0.40	V
Common Mode Rejection Ratio	CMR	V _{IC} =V _{ICmin}	—	71	—	—	75	—	dB
Supply Voltage Rejection Ratio	SVR	V _{DD} =5~10V	—	80	—	—	85	—	dB
Operating Current	I _{DD}	No Load, V _O =0V	—	22	40	—	44	80	μA

(Note2) This condition is available for operating voltage V_{DD}=5~10V and driving voltage is over 4.5V or under 0.3V.

■ SWITCHING CHARACTERISTICS

(Ta=25°C, V_{DD}=5V f=10kHz, C_L=15pF)

PARAMETER	SYMBOL	CONDITIONS	NJU7112A			NJU7114A			UNIT	
			MIN	TYP	MAX	MIN	TYP	MAX		
Propagation Delay High to Low	t _{PHL}	V _{IC} =0V	Over Drive=5mV	—	2.7	—	—	2.9	—	μs
			TTL level step	—	0.16	—	—	0.16	—	
Propagation Delay Low to High	t _{PLH}	V _{IC} =0V	Over Drive=5mV	—	1.5	—	—	1.5	—	μs
			TTL level step	—	0.7	—	—	0.8	—	
Output Signal Falling Time	t _{FHL}	Over Drive=50mV	—	20	—	—	20	—	ns	



■ MEASUREMENT CIRCUIT

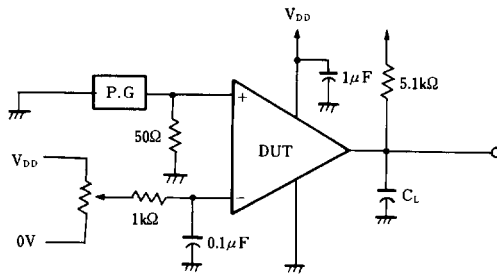

■ TIMING WAVEFORM

