

TRIPLE BIDIRECTIONAL THYRISTOR OVERVOLTAGE PROTECTORS

TELECOMMUNICATION SYSTEM SECONDARY PROTECTION

- **Patented Ion-Implanted Breakdown Region**
– Precise DC and Dynamic Voltages

DEVICE	V _{DRM} V	V _(BO) V
'7072F3	58	72
'7082F3	66	82

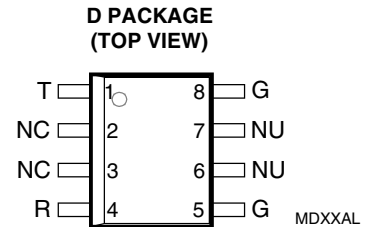

- **Planar Passivated Junctions**
– Low Off-State Current < 10 µA
- **Rated for International Surge Wave Shapes**
– Single and Simultaneous Impulses

WAVE SHAPE	STANDARD	I _{TSP} A
2/10	GR-1089-CORE	85
8/20	IEC 61000-4-5	80
10/160	FCC Part 68	65
10/700	FCC Part 68 ITU-T K.20/21	50
10/560	FCC Part 68	45
10/1000	GR-1089-CORE	40

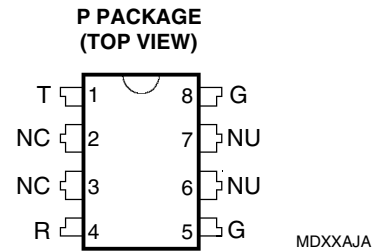

NC - No internal connection
 NU - Nonusable; no external electrical connection should be made to these pins.
 Specified ratings require connection of pin 5 and pin 8.

-UL Recognized Component

description

The TISP7xxxF3 series are 3-point overvoltage protectors designed for protecting against metallic (differential mode) and simultaneous longitudinal (common mode) surges. Each terminal pair has the same voltage limiting values and surge current capability. This terminal pair surge capability ensures that the protector can meet the simultaneous longitudinal surge requirement which is typically twice the metallic surge requirement.

Each terminal pair has a symmetrical voltage-triggered thyristor characteristic. Overvoltages are initially clipped by breakdown clamping until the voltage rises to the breakover level, which causes the device to crowbar into a low-voltage on state. This low-voltage on state causes the current resulting from the overvoltage to be .

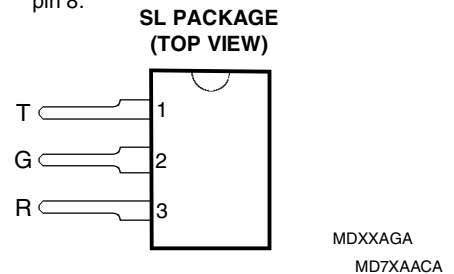

device symbol

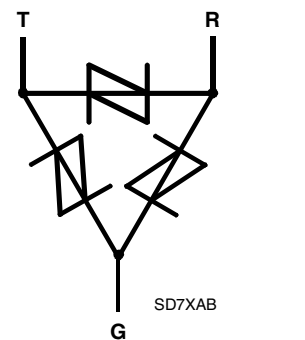

Terminals T, R and G correspond to the alternative line designators of A, B and C

AVAILABLE OPTIONS

DEVICE	PACKAGE	CARRIER	ORDER #
TISP7xxxF3	D, Small-outline	TAPE AND REEL	TISP7xxxF3DR
		TUBE	TISP7xxxF3D
TISP7xxxF3	P, Plastic DIP	TUBE	TISP7xxxF3P
TISP7xxxF3	SL, Single-in-line	TUBE	TISP7xxxF3SL

PRODUCT INFORMATION

Information is current as of publication date. Products conform to specifications in accordance with the terms of Power Innovations standard warranty. Production processing does not necessarily include testing of all parameters.



TRIPLE BIDIRECTIONAL THYRISTOR OVERVOLTAGE PROTECTORS

MARCH 1994 - REVISED MARCH 2000

description (continued)

safely diverted through the device. The high crowbar holding current prevents d.c. latchup as the diverted current subsides. These protectors are guaranteed to voltage limit and withstand the listed lightning surges in both polarities.

These low voltage devices are guaranteed to suppress and withstand the listed international lightning surges on any terminal pair. Nine similar devices with working voltages from 100 V to 275 V are detailed in the TISP7125F3 thru TISP7380F3 data sheet.

absolute maximum ratings, $T_A = 25\text{ }^\circ\text{C}$ (unless otherwise noted)

RATING	SYMBOL	VALUE	UNIT
Repetitive peak off-state voltage, $0\text{ }^\circ\text{C} < T_A < 70\text{ }^\circ\text{C}$	V_{DRM}	58	V
7072F3 7082F3		66	
Non-repetitive peak on-state pulse current (see Notes 1 and 2)	I_{PPSM}		A
1/2 (Gas tube differential transient, 1/2 voltage wave shape)		240	
2/10 (Telcordia GR-1089-CORE, 2/10 voltage wave shape)		85	
1/20 (ITU-T K.22, 1.2/50 voltage wave shape, 25 Ω resistor)		45	
8/20 (IEC 61000-4-5, combination wave generator, 1.2/50 voltage wave shape)		80	
10/160 (FCC Part 68, 10/160 voltage wave shape)		65	
4/250 (ITU-T K.20/21, 10/700 voltage wave shape, simultaneous)		60	
0.2/310 (CNET I 31-24, 0.5/700 voltage wave shape)		50	
5/310 (ITU-T K.20/21, 10/700 voltage wave shape, single)		50	
5/320 (FCC Part 68, 9/720 voltage wave shape, single)		50	
10/560 (FCC Part 68, 10/560 voltage wave shape)		45	
10/1000 (Telcordia GR-1089-CORE, 10/1000 voltage wave shape)	40		
Non-repetitive peak on-state current, $0\text{ }^\circ\text{C} < T_A < 70\text{ }^\circ\text{C}$ (see Notes 1 and 3) 50 Hz, 1 s	I_{TSM}	4.3	A
D Package		5.7	
P Package SL Package		7.1	
Initial rate of rise of on-state current, Linear current ramp, Maximum ramp value $< 38\text{ A}$	di_{T}/dt	250	A/ μs
Junction temperature	T_{J}	-65 to +150	$^\circ\text{C}$
Storage temperature range	T_{stg}	-65 to +150	$^\circ\text{C}$

- NOTES: 1. Initially the TISP[®] must be in thermal equilibrium at the specified T_A . The surge may be repeated after the TISP[®] returns to its initial conditions. The rated current values may be applied singly either to the R to G or to the T to G or to the T to R terminals. Additionally, both R to G and T to G may have their rated current values applied simultaneously (In this case the total G terminal current will be twice the above rated current values).
2. See Thermal Information for derated I_{PPSM} values $0\text{ }^\circ\text{C} < T_A < 70\text{ }^\circ\text{C}$ and Applications Information for details on wave shapes.
3. Above $70\text{ }^\circ\text{C}$, derate I_{TSM} linearly to zero at $150\text{ }^\circ\text{C}$ lead temperature.

TRIPLE BIDIRECTIONAL THYRISTOR OVERVOLTAGE PROTECTORS

MARCH 1994 - REVISED MARCH 2000

electrical characteristics for all terminal pairs, $T_A = 25\text{ }^\circ\text{C}$ (unless otherwise noted)

PARAMETER	TEST CONDITIONS	MIN	TYP	MAX	UNIT
I_{DRM} Repetitive peak off-state current	$V_D = V_{DRM}$, $0\text{ }^\circ\text{C} < T_A < 70\text{ }^\circ\text{C}$			± 10	μA
$V_{(BO)}$ Breakover voltage	$dv/dt = \pm 250\text{ V/ms}$, $R_{SOURCE} = 300\ \Omega$	'7072F3 '7082F3		± 72 ± 82	V
$V_{(BO)}$ Impulse breakover voltage	$dv/dt \leq \pm 1000\text{ V}/\mu\text{s}$, Linear voltage ramp, Maximum ramp value = $\pm 500\text{ V}$ $di/dt = \pm 20\text{ A}/\mu\text{s}$, Linear current ramp, Maximum ramp value = $\pm 10\text{ A}$	'7072F3 '7082F3		± 90 ± 100	V
$I_{(BO)}$ Breakover current	$dv/dt = \pm 250\text{ V/ms}$, $R_{SOURCE} = 300\ \Omega$	± 0.1		± 0.8	A
V_T On-state voltage	$I_T = \pm 5\text{ A}$, $t_W = 100\ \mu\text{s}$			± 5	V
I_H Holding current	$I_T = \pm 5\text{ A}$, $di/dt = \pm 30\text{ mA/ms}$	± 0.15			A
dv/dt Critical rate of rise of off-state voltage	Linear voltage ramp, Maximum ramp value $< 0.85V_{DRM}$	± 5			$\text{kV}/\mu\text{s}$
I_D Off-state current	$V_D = \pm 50\text{ V}$			± 10	μA
C_{off} Off-state capacitance	$f = 1\text{ MHz}$, $V_d = 1\text{ V rms}$, $V_D = 0$ $f = 1\text{ MHz}$, $V_d = 1\text{ V rms}$, $V_D = -1\text{ V}$ $f = 1\text{ MHz}$, $V_d = 1\text{ V rms}$, $V_D = -2\text{ V}$ $f = 1\text{ MHz}$, $V_d = 1\text{ V rms}$, $V_D = -5\text{ V}$ $f = 1\text{ MHz}$, $V_d = 1\text{ V rms}$, $V_D = -50\text{ V}$ $f = 1\text{ MHz}$, $V_d = 1\text{ V rms}$, $V_{DTR} = 0$ (see Note 4)		53 56 51 43 25 29	69 73 66 56 33 37	pF

NOTE 4: Three-terminal guarded measurement, unmeasured terminal voltage bias is zero. First five capacitance values, with bias V_D , are for the R-G and T-G terminals only. The last capacitance value, with bias V_{DTR} , is for the T-R terminals.

TRIPLE BIDIRECTIONAL THYRISTOR OVERVOLTAGE PROTECTORS

MARCH 1994 - REVISED MARCH 2000

thermal characteristics

PARAMETER	TEST CONDITIONS	MIN	TYP	MAX	UNIT
$R_{\theta JA}$ Junction to free air thermal resistance	$P_{tot} = 0.8 \text{ W}$, $T_A = 25^\circ\text{C}$ 5 cm ² , FR4 PCB	D Package		160	°C/W
		P Package		100	
		SL Package		135	

PARAMETER MEASUREMENT INFORMATION

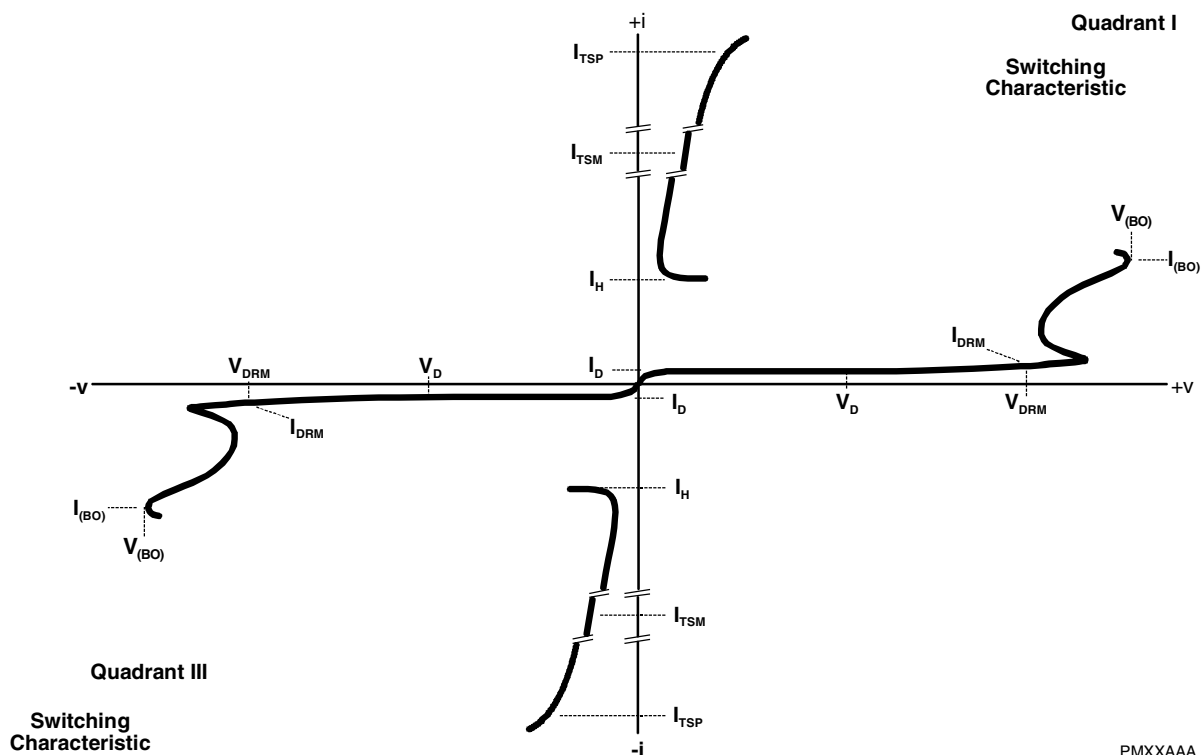

Figure 1. VOLTAGE-CURRENT CHARACTERISTIC FOR T AND R TERMINALS
 T and G and R and G measurements are referenced to the G terminal
 T and R measurements are referenced to the R terminal

PMXXAAA

PRODUCT INFORMATION

TRIPLE BIDIRECTIONAL THYRISTOR OVERVOLTAGE PROTECTORS

MARCH 1994 - REVISED MARCH 2000

TYPICAL CHARACTERISTICS
R and G, or T and G terminals

OFF-STATE CURRENT

vs

JUNCTION TEMPERATURE

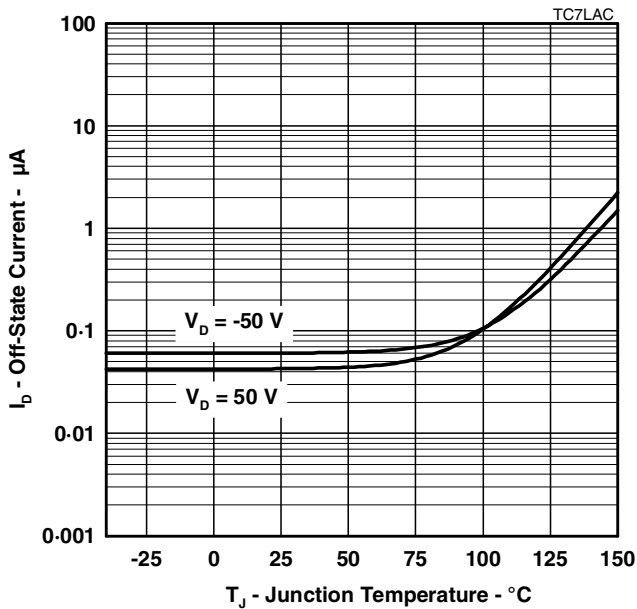

Figure 2.

NORMALISED BREAKDOWN VOLTAGES

vs

JUNCTION TEMPERATURE

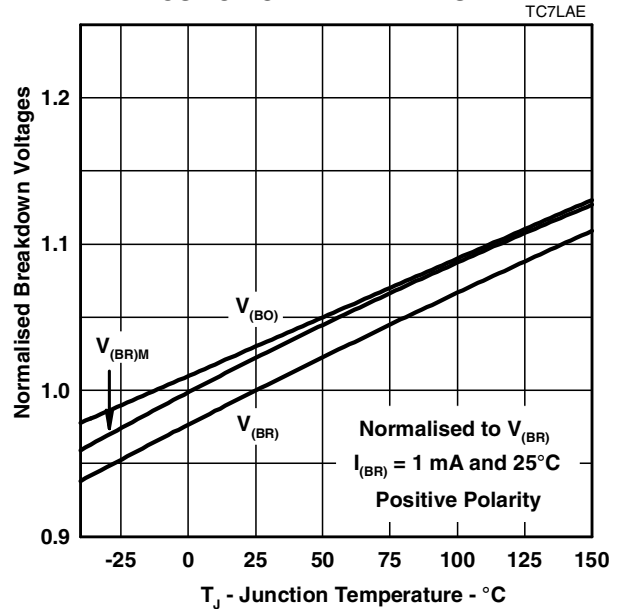

Figure 3.

NORMALISED BREAKDOWN VOLTAGES

vs

JUNCTION TEMPERATURE

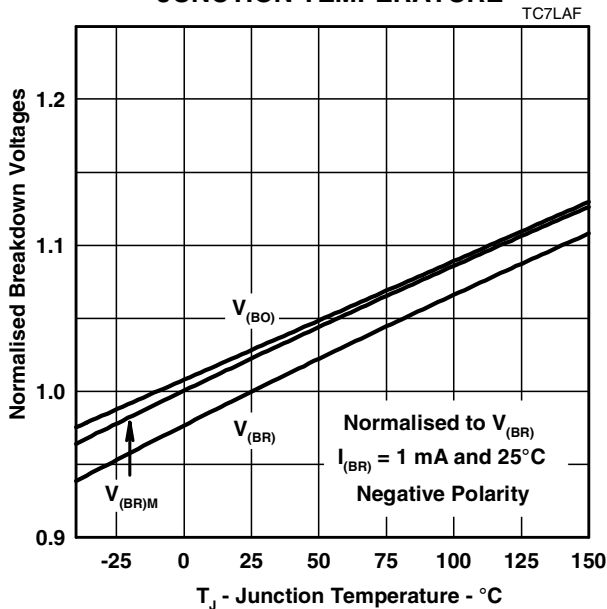

Figure 4.

ON-STATE CURRENT

vs

ON-STATE VOLTAGE

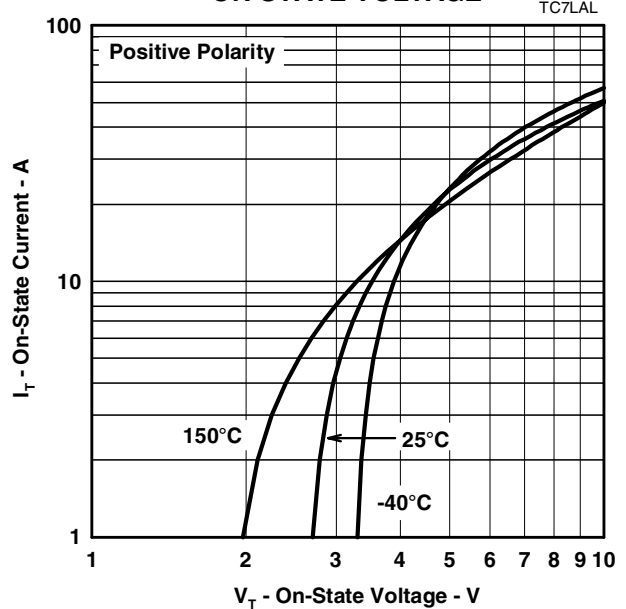
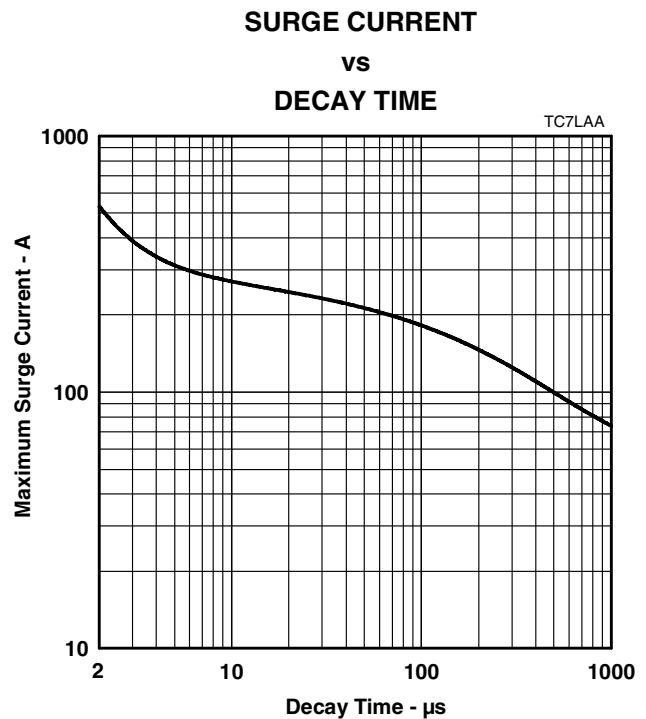
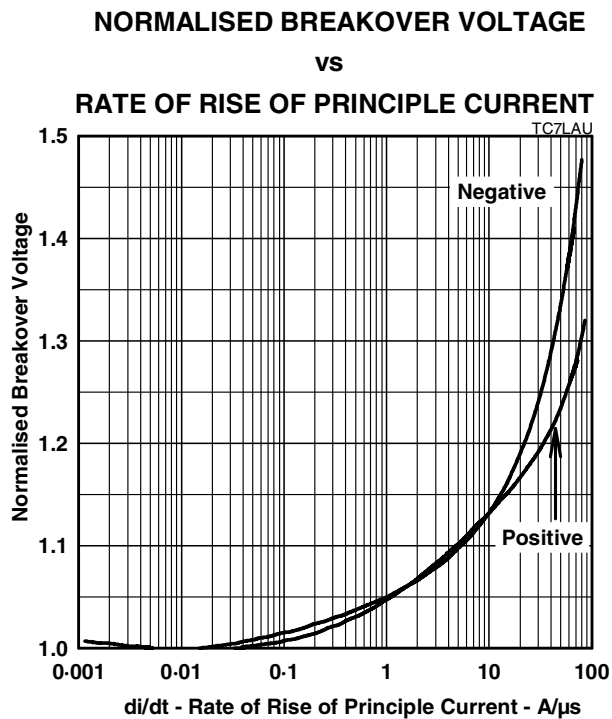
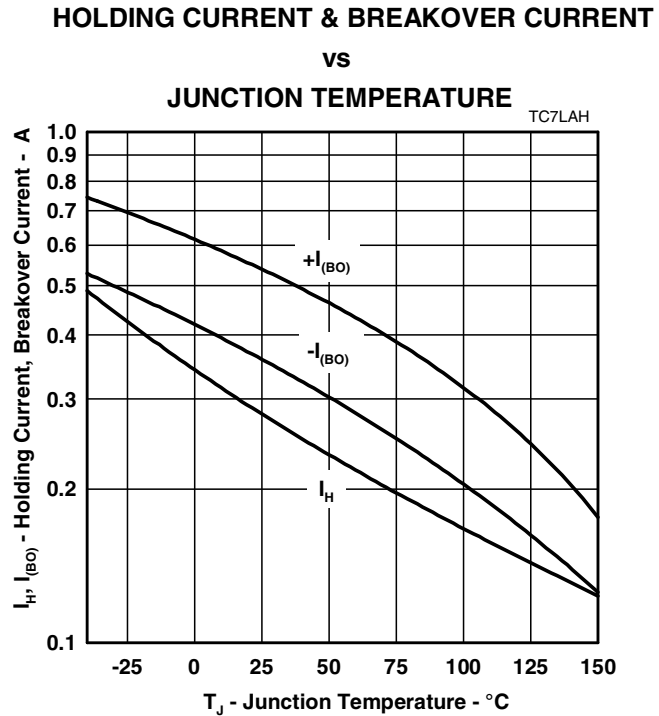
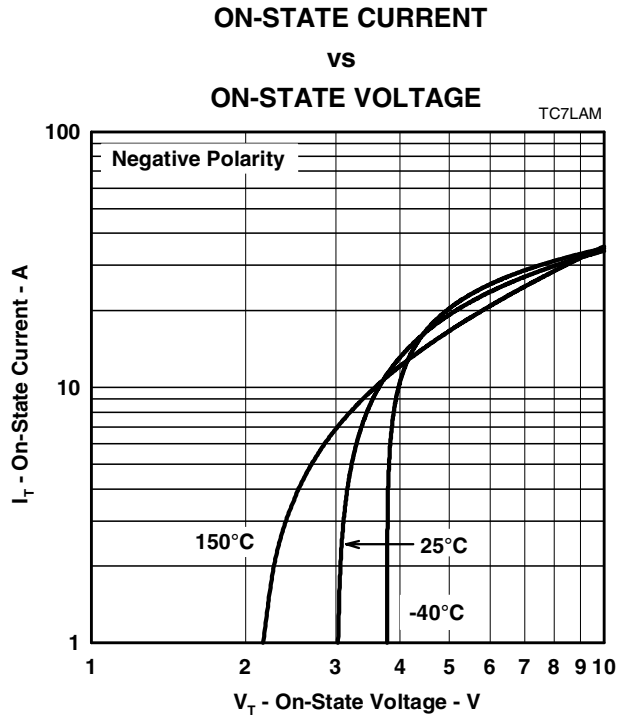

Figure 5.

TRIPLE BIDIRECTIONAL THYRISTOR OVERVOLTAGE PROTECTORS

MARCH 1994 - REVISED MARCH 2000

TYPICAL CHARACTERISTICS
R and G, or T and G terminals



PRODUCT INFORMATION

TRIPLE BIDIRECTIONAL THYRISTOR OVERVOLTAGE PROTECTORS

MARCH 1994 - REVISED MARCH 2000

TYPICAL CHARACTERISTICS
R and T terminals

OFF-STATE CURRENT
vs
JUNCTION TEMPERATURE

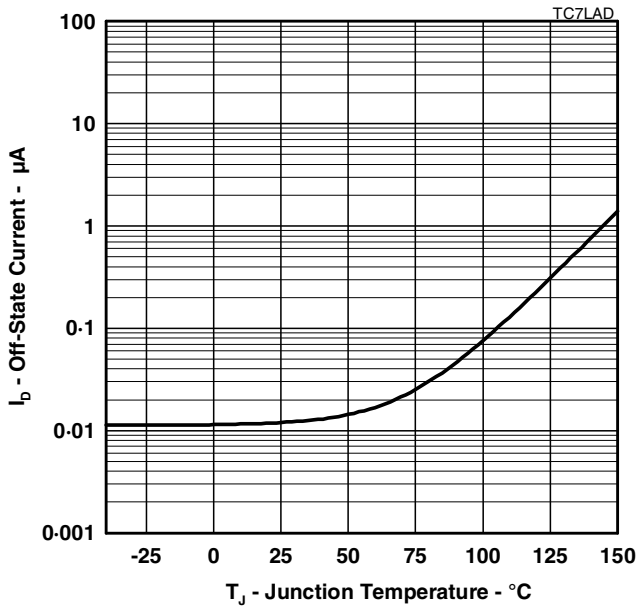

Figure 10.

NORMALISED BREAKDOWN VOLTAGES
vs
JUNCTION TEMPERATURE

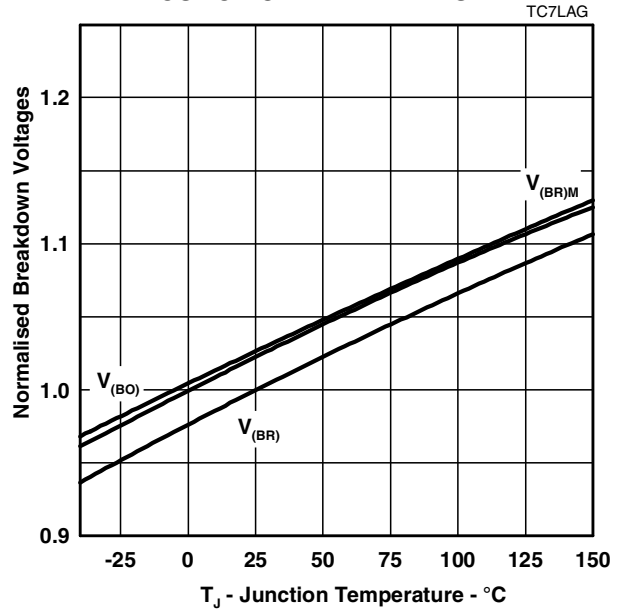

Figure 11.

ON-STATE CURRENT
vs
ON-STATE VOLTAGE

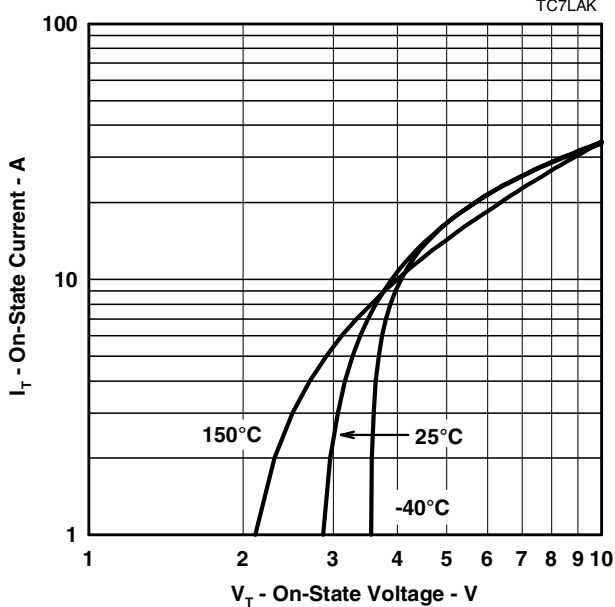

Figure 12.

HOLDING CURRENT & BREAKOVER CURRENT
vs
JUNCTION TEMPERATURE

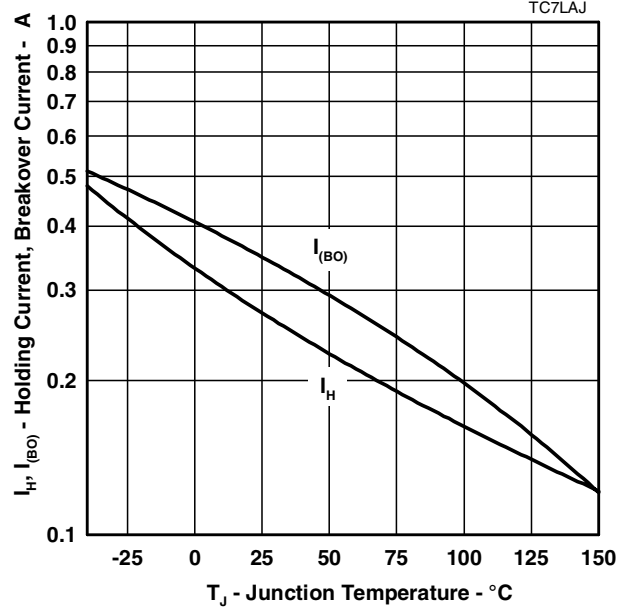

Figure 13.

TRIPLE BIDIRECTIONAL THYRISTOR OVERVOLTAGE PROTECTORS

MARCH 1994 - REVISED MARCH 2000

TYPICAL CHARACTERISTICS R and T terminals

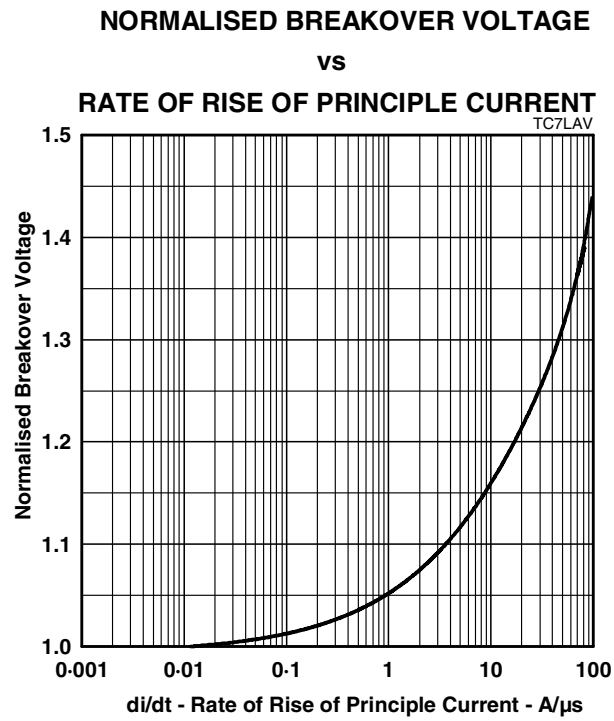

Figure 14.

TRIPLE BIDIRECTIONAL THYRISTOR OVERVOLTAGE PROTECTORS

MARCH 1994 - REVISED MARCH 2000

THERMAL INFORMATION

MAXIMUM NON-RECURRING 50 Hz CURRENT
VS
CURRENT DURATION

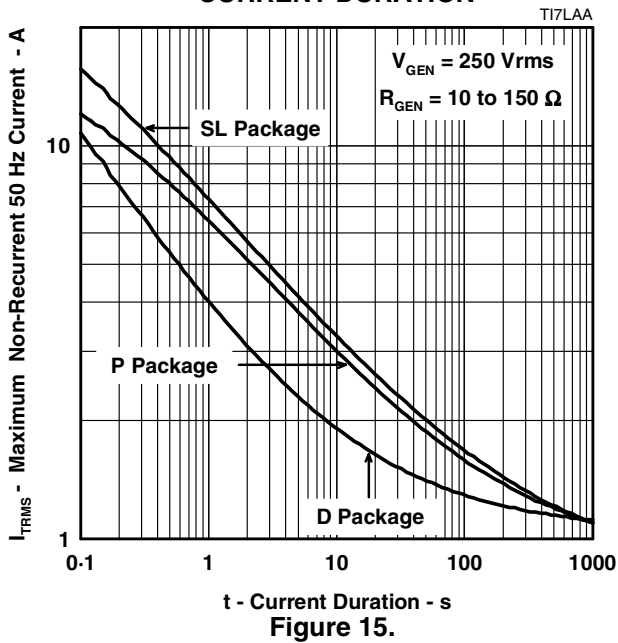

Figure 15.

THERMAL RESPONSE

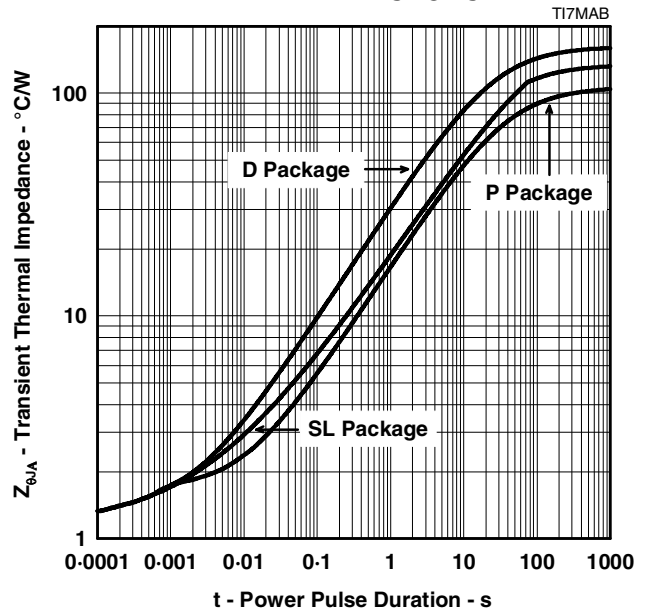

Figure 16.

TRIPLE BIDIRECTIONAL THYRISTOR OVERVOLTAGE PROTECTORS

MARCH 1994 - REVISED MARCH 2000

THERMAL INFORMATION**Non-repetitive peak on-state pulse derated values for $0\text{ }^{\circ}\text{C} \leq T_A \leq 70\text{ }^{\circ}\text{C}$**

RATING	SYMBOL	VALUE	UNIT
Non-repetitive peak on-state pulse current, $0\text{ }^{\circ}\text{C} < T_A < 70\text{ }^{\circ}\text{C}$ (see Notes 5, 6 and 7)			
1/2 (Gas tube differential transient, 1/2 voltage wave shape)		130	
2/10 (Telcordia GR-1089-CORE, 2/10 voltage wave shape)		80	
1/20 (ITU-T K.22, 1.2/50 voltage wave shape, 25 Ω resistor)		45	
8/20 (IEC 61000-4-5, combination wave generator, 1.2/50 voltage wave shape)		75	
10/160 (FCC Part 68, 10/160 voltage wave shape)		55	
4/250 (ITU-T K.20/21, 10/700 voltage wave shape, dual)	I_{PPSM}	50	A
0.2/310 (CNET I 31-24, 0.5/700 voltage wave shape)		50	
5/310 (ITU-T K.20/21, 10/700 voltage wave shape, single)		50	
5/320 (FCC Part 68, 9/720 voltage wave shape)		50	
10/560 (FCC Part 68, 10/560 voltage wave shape)		40	
10/1000 (Telcordia GR-1089-CORE, 10/1000 voltage wave shape)		40	

- NOTES: 5. Initially the TISP[®] must be in thermal equilibrium at the specified T_A . The impulse may be repeated after the TISP[®] returns to its initial conditions. The rated current values may be applied either to the R to G or to the T to G or to the T to R terminals. Additionally, both R to G and T to G may have their rated current values applied simultaneously (In this case the total G terminal current will be twice the above rated current values).
6. See Applications Information for details on wave shapes.
7. Above 70 $^{\circ}\text{C}$, derate I_{PPSM} linearly to zero at 150 $^{\circ}\text{C}$ lead temperature.

TRIPLE BIDIRECTIONAL THYRISTOR OVERVOLTAGE PROTECTORS

MARCH 1994 - REVISED MARCH 2000

APPLICATIONS INFORMATION

deployment

These devices are three terminal overvoltage protectors. They limit the voltage between three points in the circuit. Typically, this would be the two line conductors and protective ground (Figure 17).

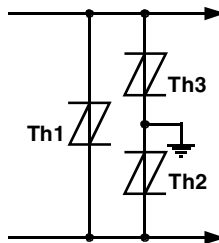

Figure 17. MULTI-POINT PROTECTION

In Figure 17, protectors Th2 and Th3 limit the maximum voltage between each conductor and ground to the $\pm V_{(BO)}$ of the individual protector. Protector Th1 limits the maximum voltage between the two conductors to its $\pm V_{(BO)}$ value.

lightning surge**wave shape notation**

Most lightning tests, used for equipment verification, specify a unidirectional sawtooth waveform which has an exponential rise and an exponential decay. Wave shapes are classified in terms of rise time in microseconds and a decay time in microseconds to 50% of the maximum amplitude. The notation used for the wave shape is *rise time/decay time*, without the microseconds quantity and the “/” between the two values has no mathematical significance. A 50A, 5/310 waveform would have a peak current value of 50 A, a rise time of 5 μ s and a decay time of 310 μ s. The TISP[®] surge current graph comprehends the wave shapes of commonly used surges.

generators

There are three categories of surge generator type: single wave shape, combination wave shape and circuit defined. Single wave shape generators have essentially the same wave shape for the open circuit voltage and short circuit current (e.g. 10/1000 open circuit voltage and short circuit current). Combination generators have two wave shapes, one for the open circuit voltage and the other for the short circuit current (e.g. 1.2/50 open circuit voltage and 8/20 short circuit current) Circuit specified generators usually equate to a combination generator, although typically only the open circuit voltage wave shape is referenced (e.g. a 10/700 open circuit voltage generator typically produces a 5/310 short circuit current). If the combination or circuit defined generators operate into a finite resistance the wave shape produced is intermediate between the open circuit and short circuit values.

ITU-T 10/700 generator

This circuit defined generator is specified in many standards. The descriptions and values are not consistent between standards and it is important to realise that it is always the same generator being used.

Figure 18 shows the 10/700 generator circuit defined in ITU-T recommendation K.20 (10/96) “Resistibility of telecommunication switching equipment to overvoltages and overcurrents”. The basic generator comprises of:

capacitor C_1 , charged to voltage V_C , which is the energy storage element.
switch SW to discharge the capacitor into the output shaping network

TRIPLE BIDIRECTIONAL THYRISTOR OVERVOLTAGE PROTECTORS

MARCH 1994 - REVISED MARCH 2000

shunt resistor R_1 , series resistor R_2 and shunt capacitor C_2 form the output shaping network.
 series feed resistor R_3 to connect to one line conductor for single surge
 series feed resistor R_4 to connect to the other line conductor for dual surging

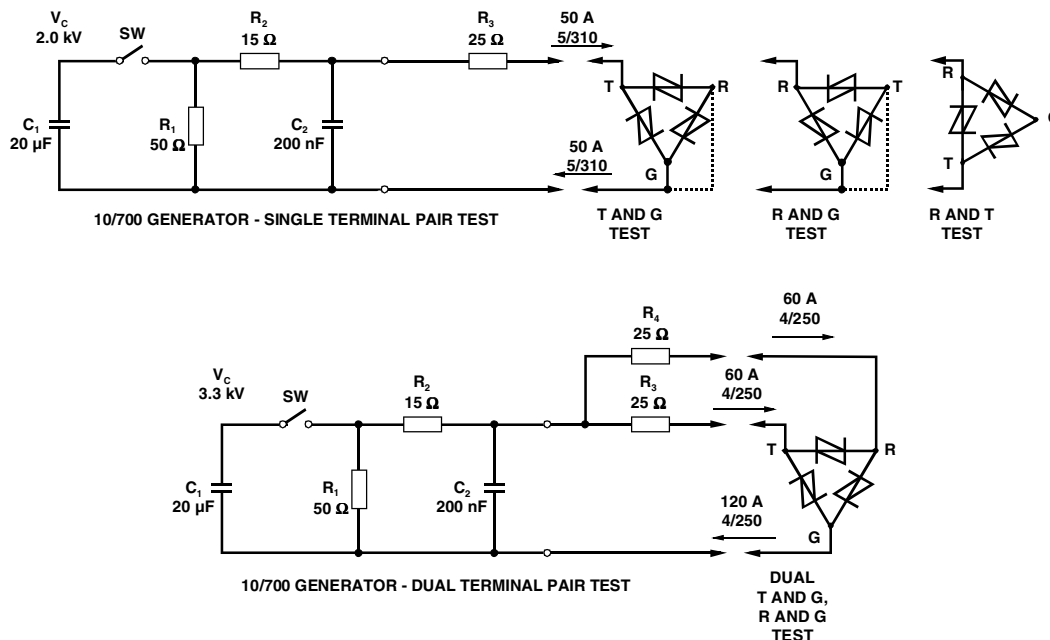

Figure 18.

In the normal single surge equipment test configuration, the unsurged line is grounded. This is shown by the dotted lines in the top drawing of Figure 18. However, doing this at device test places one terminal pair in parallel with another terminal pair. To check the individual terminal pairs of the TISP7xxF3, without any paralleled operation, the unsurged terminal is left unconnected.

With the generator output open circuit, when SW closes, C_1 discharges through R_1 . The decay time constant will be $C_1 R_1$, or $20 \times 50 = 1000 \mu\text{s}$. For the 50% voltage decay time the time constant needs to be multiplied by 0.697, giving $0.697 \times 1000 = 697 \mu\text{s}$ which is rounded to $700 \mu\text{s}$.

The output rise time is controlled by the time constant of R_2 and C_2 , which is $15 \times 200 = 3000 \text{ ns}$ or $3 \mu\text{s}$. Virtual voltage rise times are given by straight line extrapolation through the 30% and 90% points of the voltage waveform to zero and 100%. Mathematically this is equivalent to 3.24 times the time constant, which gives $3.24 \times 3 = 9.73$ which is rounded to $10 \mu\text{s}$. Thus the open circuit voltage rises in $10 \mu\text{s}$ and decays in $700 \mu\text{s}$, giving the 10/700 generator its name.

When the overvoltage protector switches it effectively shorts the generator output via the series 25Ω resistor. Two short circuit conditions need to be considered: single output using R_3 only (top circuit of Figure 18) and dual output using R_3 and R_4 (bottom circuit of Figure 18).

For the single test, the series combination of R_2 and R_3 ($15 + 25 = 40 \Omega$) is in shunt with R_1 . This lowers the discharge resistance from 50Ω to 22.2Ω , giving a discharge time constant of $444 \mu\text{s}$ and a 50% current decay time of $309.7 \mu\text{s}$, which is rounded to $310 \mu\text{s}$.

For the rise time, R_2 and R_3 are in parallel, reducing the effective source resistance from 15Ω to 9.38Ω , giving a time constant of $1.88 \mu\text{s}$. Virtual current rise times are given by straight line extrapolation through the 10% and 90% points of the current waveform to zero and 100%. Mathematically this is equivalent to 2.75

TRIPLE BIDIRECTIONAL THYRISTOR OVERVOLTAGE PROTECTORS

MARCH 1994 - REVISED MARCH 2000

times the time constant, which gives $2.75 \times 1.88 = 5.15$, which is rounded to $5 \mu\text{s}$. Thus the short circuit current rises in $5 \mu\text{s}$ and decays in $310 \mu\text{s}$, giving the 5/310 wave shape.

The series resistance from C_1 to the output is 40Ω giving an output conductance of 25 A/kV . For each 1 kV of capacitor charge voltage, 25 A of output current will result.

For the dual test, the series combination of R_2 plus R_3 and R_4 in parallel ($15 + 12.5 = 27.5 \Omega$) is in shunt with R_1 . This lowers the discharge resistance from 50Ω to 17.7Ω , giving a discharge time constant of $355 \mu\text{s}$ and a 50% current decay time of $247 \mu\text{s}$, which is rounded to $250 \mu\text{s}$.

For the rise time, R_2 , R_3 and R_4 are in parallel, reducing the effective source resistance from 15Ω to 6.82Ω , giving a time constant of $1.36 \mu\text{s}$, which gives a current rise time of $2.75 \times 1.36 = 3.75$, which is rounded to $4 \mu\text{s}$. Thus the short circuit current rises in $4 \mu\text{s}$ and decays in $250 \mu\text{s}$, giving the 4/250 wave shape.

The series resistance from C_1 to an *individual* output is $2 \times 27.5 = 55 \Omega$ giving an output conductance of 18 A/kV . For each 1 kV of capacitor charge voltage, 18 A of output current will result.

At 25°C these protectors are rated at 50 A for the single terminal pair condition and 60 A for the dual condition (R and G terminals and T and G terminals). In terms of generator voltage, this gives a maximum generator setting of $50 \times 40 = 2.0 \text{ kV}$ for the single condition and $2 \times 60 \times 27.5 = 3.3 \text{ kV}$ for the dual condition. The higher generator voltage setting for the dual condition is due to the current waveform decay being shorter at $250 \mu\text{s}$ compared to the $310 \mu\text{s}$ value of the single condition.

Other ITU-T recommendations use the 10/700 generator: K.17 (11/88) "Tests on power-fed repeaters using solid-state devices in order to check the arrangements for protection from external interference" and K.21 (10/96) "Resistibility of subscriber's terminal to overvoltages and overcurrents", K.30 (03/93) "Positive temperature coefficient (PTC) thermistors".

Several IEC publications use the 10/700 generator, common ones are IEC 6100-4-5 (03/95) "Electromagnetic compatibility (EMC) - Part 4: Testing and measurement techniques - Section 5: Surge immunity test" and IEC 60950 (04/99) "Safety of information technology equipment".

The IEC 60950 10/700 generator is carried through into other "950" derivatives. Europe is harmonised by CENELEC (Comité Européen de Normalization Electro-technique) under EN 60950 (included in the Low Voltage Directive, CE mark). US has UL (Underwriters Laboratories) 1950 and Canada CSA (Canadian Standards Authority) C22.2 No. 950.

FCC Part 68 "Connection of terminal equipment to the telephone network" (47 CFR 68) uses the 10/700 generator for Type B surge testing. Part 68 defines the open circuit voltage wave shape as 9/720 and the short circuit current wave shape as 5/320 for a single output. The current wave shape in the dual (longitudinal) test condition is not defined, but it can be assumed to be 4/250.

Several VDE publications use the 10/700 generator, for example: VDE 0878 Part 200 (12/92) "Electromagnetic compatibility of information technology equipment and telecommunications equipment; Immunity of analogue subscriber equipment".

1.2/50 generators

The 1.2/50 open circuit voltage and 8/20 short circuit current combination generator is defined in IEC 61000-4-5 (03/95) "Electromagnetic compatibility (EMC) - Part 4: Testing and measurement techniques - Section 5: Surge immunity test". This generator has a fictive output resistance of 2Ω , meaning that dividing the open circuit output voltage by the short circuit output current gives a value of 2Ω (500 A/kV).

TRIPLE BIDIRECTIONAL THYRISTOR OVERVOLTAGE PROTECTORS

MARCH 1994 - REVISED MARCH 2000

The combination generator has three testing configurations; directly applied for testing between equipment a.c. supply connections, applied via an external 10 Ω resistor for testing between the a.c. supply connections and ground, and applied via an external 40 Ω resistor for testing all other lines. For unshielded unsymmetrical data or signalling lines, the combination generator is applied via a 40 Ω resistor either between lines or line to ground. For unshielded symmetrical telecommunication lines, the combination generator is applied to all lines via a resistor of $n \times 40 \Omega$, where n is the number of conductors and the maximum value of external feed resistance is 250 Ω . Thus for four conductors $n = 4$ and the series resistance is $4 \times 40 = 160 \Omega$. For ten conductors the resistance cannot be $10 \times 40 = 400 \Omega$ and must be 250 Ω . The combination generator is used for short distance lines, long distance lines are tested with the 10/700 generator.

When the combination generator is used with a 40 Ω , or more, external resistor, the current wave shape is not 8/20, but becomes closer to the open circuit voltage wave shape of 1.2/50. For example, a commercial generator when used with 40 Ω produced an 1.4/50 wave shape.

The wave shapes of 1.2/50 and 8/20 occur in other generators as well. British Telecommunication has a combination generator with 1.2/50 voltage and 8/20 current wave shapes, but it has a fictive resistance of 1 Ω . ITU-T recommendation K.22 "Overvoltage resistibility of equipment connected to an ISDN T/S BUS" (05/95) has a 1.2/50 generator option using only resistive and capacitive elements, Figure 19.

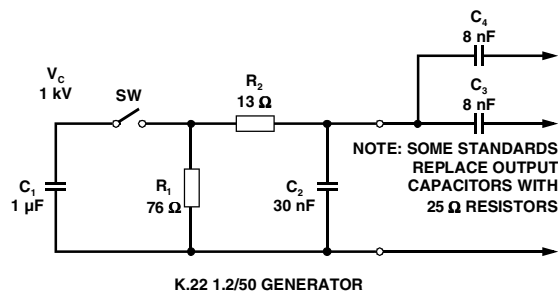

Figure 19.

The K.22 generator produces a 1.4/53 open circuit voltage wave. Using 25 Ω output resistors, gives a single short circuit current output wave shape of 0.8/18 with 26 A/kV and a dual of 0.6/13 with 20 A/kV. These current wave shapes are often rounded to 1/20 and 0.8/14.

There are 8/20 short circuit current defined generators. These are usually very high current, 10 kA or more and are used for testing a.c. protectors, primary protection modules and some Gas Discharge Tubes.

impulse testing

To verify the withstand capability and safety of the equipment, standards require that the equipment is tested with various impulse wave forms. The table in this section shows some common test values.

Manufacturers are being increasingly required to design in protection coordination. This means that each protector is operated at its design level and currents are diverted through the appropriate protector e.g. the primary level current through the primary protector and lower levels of current may be diverted through the secondary or inherent equipment protection. Without coordination, primary level currents could pass through the equipment only designed to pass secondary level currents. To ensure coordination happens with fixed voltage protectors, some resistance is normally used between the primary and secondary protection (R1a and R1b Figure 21). The coordination resistance values given in here apply to a 400 V (d.c. sparkover) gas discharge tube primary protector and the appropriate test voltage when the equipment is tested with a primary protector.

TRIPLE BIDIRECTIONAL THYRISTOR OVERVOLTAGE PROTECTORS

MARCH 1994 - REVISED MARCH 2000

STANDARD	PEAK VOLTAGE SETTING V	VOLTAGE WAVE FORM μs	PEAK CURRENT VALUE A	CURRENT WAVE FORM μs	TISP7xxxF3 25 °C RATING A	SERIES RESISTANCE Ω	COORDINATION RESISTANCE Ω (MIN.)
GR-1089-CORE	2500	2/10	2 x 500	2/10	2 x 85	25	NA
	1000	10/1000	2 x 100	10/1000	2 x 40		
FCC Part 68 (March 1998)	1500	10/160	200	10/160	65	16	NA
	800	10/560	100	10/560	45	10	
	1000	9/720 †	25	5/320 †	50	0	
	1500	(SINGLE)	37.5	5/320 †	50		
	1500	(DUAL)	2 x 27	4/250	2 x 60		
I 31-24	1500	0.5/700	37.5	0.2/310	50	0	NA
ITU-T K20/K21	1000	10/700	25	5/310	50	0	NA
	1500	(SINGLE)	37.5	5/310	50	0	NA
	4000	(SINGLE)	100	5/310	50	40	8
	4000	(DUAL)	2 x 72	4/250	2 x 60	12	7

† FCC Part 68 terminology for the waveforms produced by the ITU-T recommendation K21 10/700 impulse generator

NA = Not Applicable, primary protection removed or not specified.

If the impulse generator current exceeds the protectors current rating then a series resistance can be used to reduce the current to the protectors rated value and so prevent possible failure. The required value of series resistance for a given waveform is given by the following calculations. First, the minimum total circuit impedance is found by dividing the impulse generators peak voltage by the protectors rated current. The impulse generators fictive impedance (generators peak voltage divided by peak short circuit current) is then subtracted from the minimum total circuit impedance to give the required value of series resistance. In some cases the equipment will require verification over a temperature range. By using the derated waveform values from the thermal information section, the appropriate series resistor value can be calculated for ambient temperatures in the range of 0 °C to 70 °C.

protection voltage

The protection voltage, ($V_{(BO)}$), increases under lightning surge conditions due to thyristor regeneration. This increase is dependent on the rate of current rise, di/dt , when the TISP[®] is clamping the voltage in its breakdown region. The $V_{(BO)}$ value under surge conditions can be estimated by multiplying the 50 Hz rate $V_{(BO)}$ (250 V/ms) value by the normalised increase at the surge's di/dt . An estimate of the di/dt can be made from the surge generator voltage rate of rise, dv/dt , and the circuit resistance.

As an example, the ITU-T recommendation K.21 1.5 kV, 10/700 surge has an average dv/dt of 150 V/ μs , but, as the rise is exponential, the initial dv/dt is three times higher, being 450 V/ μs . The instantaneous generator output resistance is 25 Ω . If the equipment has an additional series resistance of 20 Ω , the total series resistance becomes 45 Ω . The maximum di/dt then can be estimated as $450/45 = 10$ A/ μs . In practice the measured di/dt and protection voltage increase will be lower due to inductive effects and the finite slope resistance of the TISP[®] breakdown region.

capacitance

off-state capacitance

The off-state capacitance of a TISP[®] is sensitive to junction temperature, T_J , and the bias voltage, comprising of the dc voltage, V_D , and the ac voltage, V_d . All the capacitance values in this data sheet are measured with an ac voltage of 1 V rms. When $V_D \gg V_d$ the capacitance value is independent on the value of V_d . Up to 10 MHz the capacitance is essentially independent of frequency. Above 10 MHz the effective capacitance is strongly dependent on connection inductance. For example, a printed wiring (PW) trace of 10 cm could create a circuit resonance with the device capacitance in the region of 80 MHz.

TRIPLE BIDIRECTIONAL THYRISTOR OVERVOLTAGE PROTECTORS

MARCH 1994 - REVISED MARCH 2000

longitudinal balance

Figure 20 shows a three terminal TISP[®] with its equivalent “delta” capacitance. Each capacitance, C_{TG} , C_{RG} and C_{TR} , is the true terminal pair capacitance measured with a three terminal or guarded capacitance bridge. If wire R is biased at a larger potential than wire T then $C_{TG} > C_{RG}$. Capacitance C_{TG} is equivalent to a capacitance of C_{RG} in parallel with the capacitive difference of $(C_{TG} - C_{RG})$. The line capacitive unbalance is due to $(C_{TG} - C_{RG})$ and the capacitance shunting the line is $C_{TR} + C_{RG}/2$.

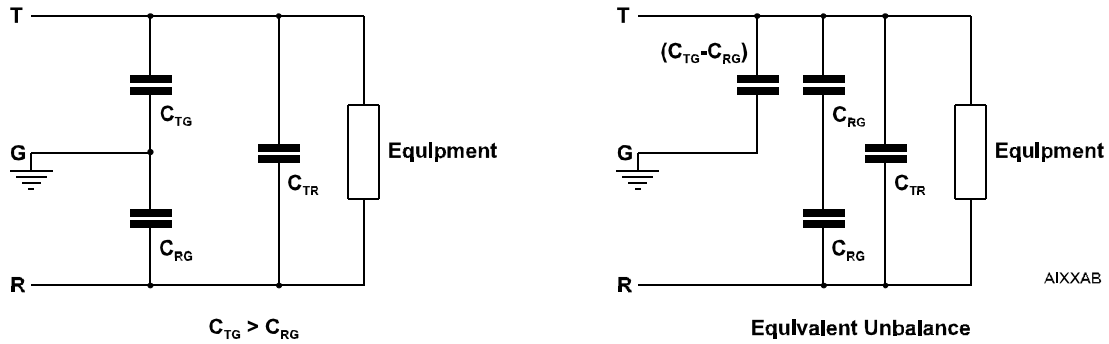

Figure 20.

All capacitance measurements in this data sheet are three terminal guarded to allow the designer to accurately assess capacitive unbalance effects. Simple two terminal capacitance meters (unguarded third terminal) give false readings as the shunt capacitance via the third terminal is included.

PRODUCT INFORMATION

TRIPLE BIDIRECTIONAL THYRISTOR OVERVOLTAGE PROTECTORS

MARCH 1994 - REVISED MARCH 2000

typical circuits

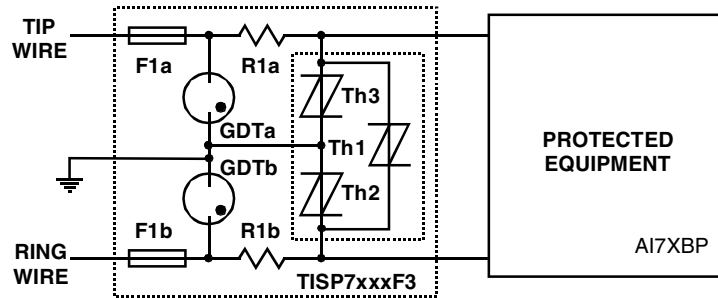

Figure 21. PROTECTION MODULE

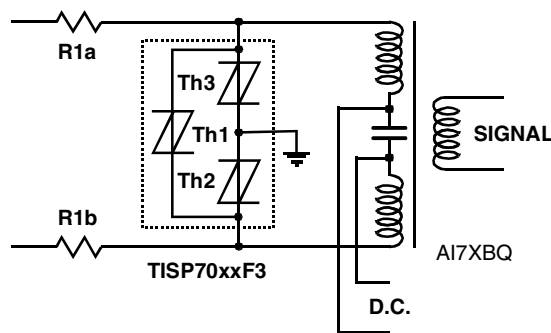

Figure 22. SELV DATA AND BATTERY FEED PROTECTION

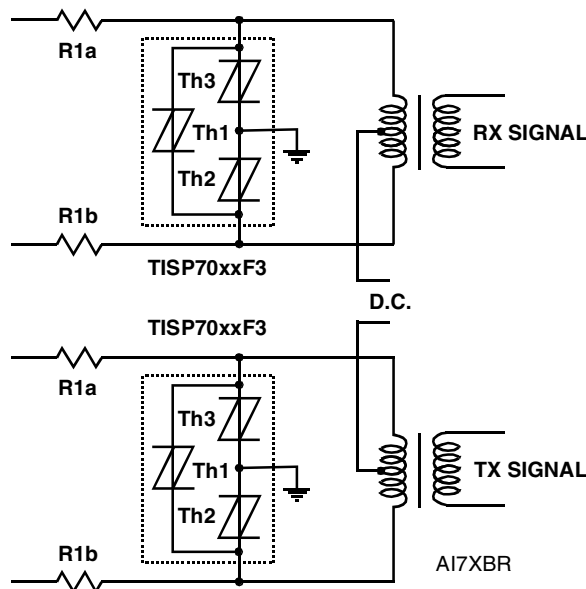

Figure 23. SELV DATA AND BATTERY FEED WITH SEPARATE RX AND TX

TRIPLE BIDIRECTIONAL THYRISTOR OVERVOLTAGE PROTECTORS

MARCH 1994 - REVISED MARCH 2000

MECHANICAL DATA

D008

plastic small-outline package

This small-outline package consists of a circuit mounted on a lead frame and encapsulated within a plastic compound. The compound will withstand soldering temperature with no deformation, and circuit performance characteristics will remain stable when operated in high humidity conditions. Leads require no additional cleaning or processing when used in soldered assembly.

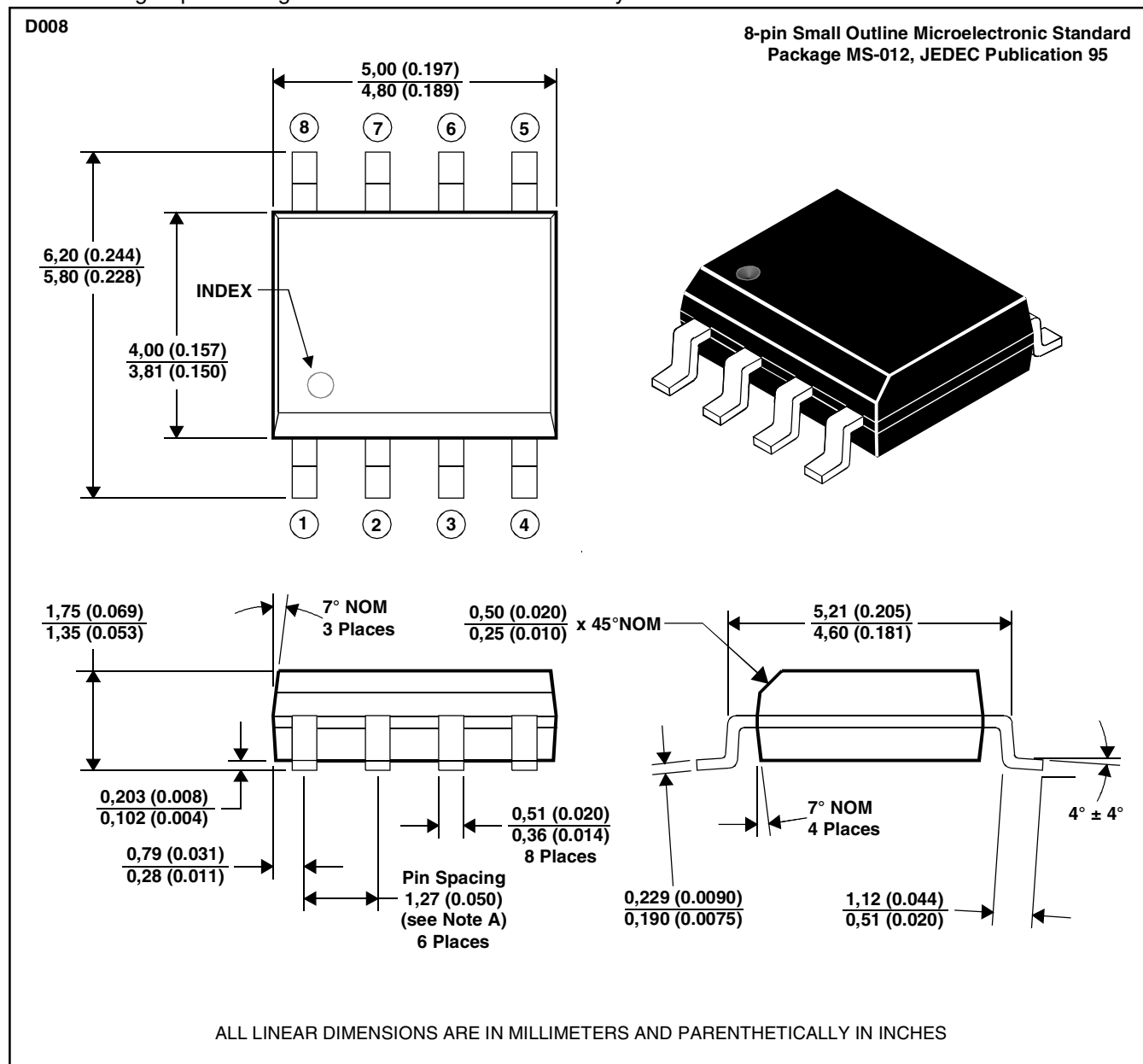

- NOTES: A. Leads are within 0,25 (0.010) radius of true position at maximum material condition.
 B. Body dimensions do not include mold flash or protrusion.
 C. Mold flash or protrusion shall not exceed 0,15 (0.006).
 D. Lead tips to be planar within ±0,051 (0.002).

MDXXAAC

PRODUCT INFORMATION

TRIPLE BIDIRECTIONAL THYRISTOR OVERVOLTAGE PROTECTORS

MARCH 1994 - REVISED MARCH 2000

MECHANICAL DATA

D008

tape dimensions

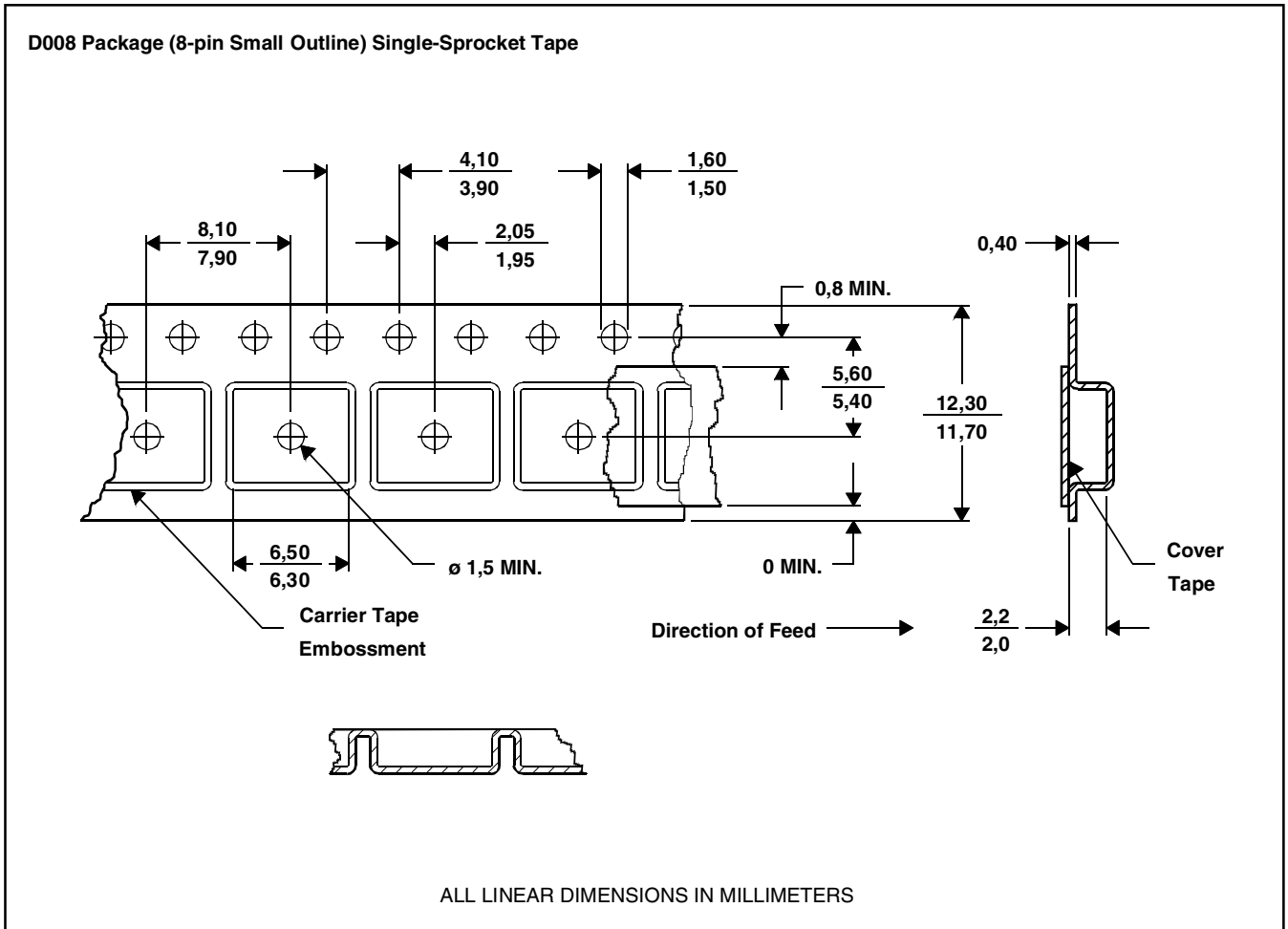

NOTES: A. Taped devices are supplied on a reel of the following dimensions:-

MDXXATB

Reel diameter:	330 +0,0/-4,0 mm
Reel hub diameter:	100 ±2,0 mm
Reel axial hole:	13,0 ±0,2 mm

B. 2500 devices are on a reel.

TRIPLE BIDIRECTIONAL THYRISTOR OVERVOLTAGE PROTECTORS

MARCH 1994 - REVISED MARCH 2000

MECHANICAL DATA

P008

plastic dual-in-line package

This dual-in-line package consists of a circuit mounted on a lead frame and encapsulated within a plastic compound. The compound will withstand soldering temperature with no deformation, and circuit performance characteristics will remain stable when operated in high humidity conditions. The package is intended for insertion in mounting-hole rows on 7,62 (0.300) centres. Once the leads are compressed and inserted, sufficient tension is provided to secure the package in the board during soldering. Leads require no additional cleaning or processing when used in soldered assembly.

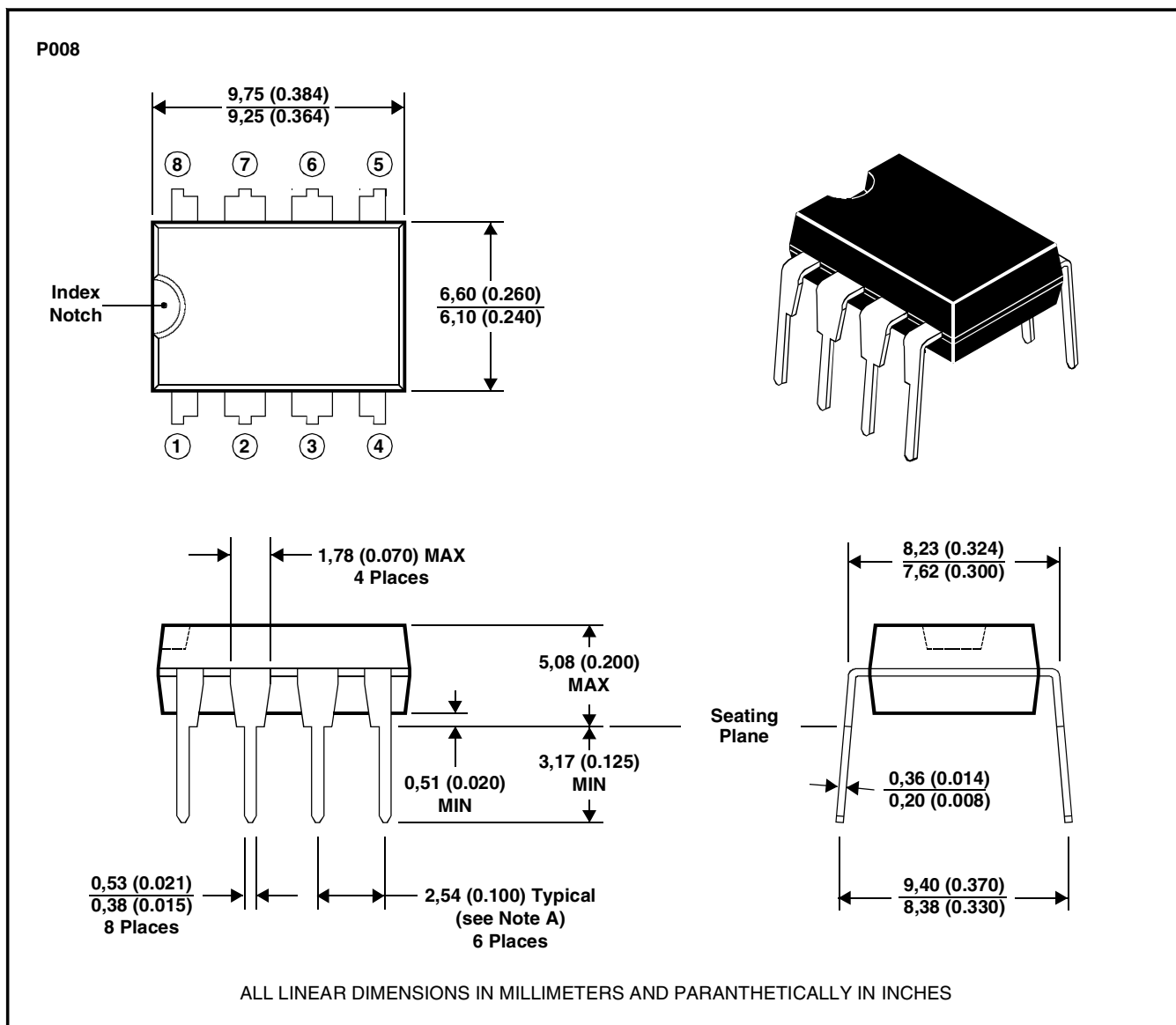

- NOTES: A. Each pin centreline is located within 0,25 (0.010) of its true longitudinal position.
 B. Dimensions fall within JEDEC MS001 - R-PDIP-T, 0.300" Dual-In-Line Plastic Family.
 C. Details of the previous dot index P008 package style, drawing reference MDXXABA, are given in the earlier publications.

MDXXCF

PRODUCT INFORMATION

TRIPLE BIDIRECTIONAL THYRISTOR OVERVOLTAGE PROTECTORS

MARCH 1994 - REVISED MARCH 2000

MECHANICAL DATA

SL003

3-pin plastic single-in-line package

This single-in-line package consists of a circuit mounted on a lead frame and encapsulated within a plastic compound. The compound will withstand soldering temperature with no deformation, and circuit performance characteristics will remain stable when operated in high humidity conditions. Leads require no additional cleaning or processing when used in soldered assembly.

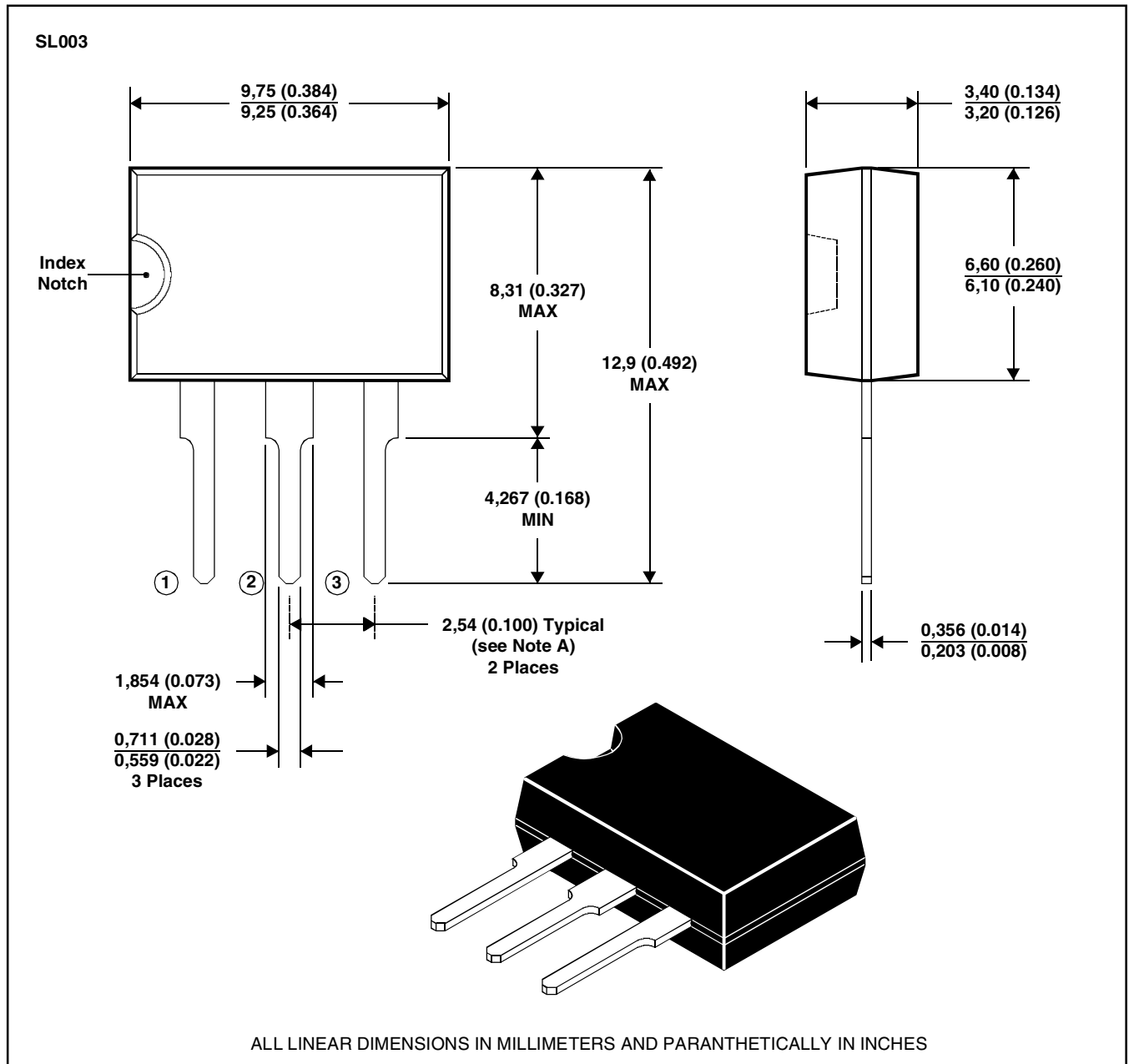

NOTES: A. Each pin centreline is located within 0,25 (0.010) of its true longitudinal position.

B. Body molding flash of up to 0,15 (0.006) may occur in the package lead plane.

C. Details of the previous dot index SL003 style, drawing reference MDXXAD, are given in the earlier publications.

MDXXCE