

**Rectifier diodes  
ultrafast, rugged**

**BYV42E, BYV42EB series**

**FEATURES**

- Low forward volt drop
- Fast switching
- Soft recovery characteristic
- Reverse surge capability
- High thermal cycling performance
- Low thermal resistance

**SYMBOL**

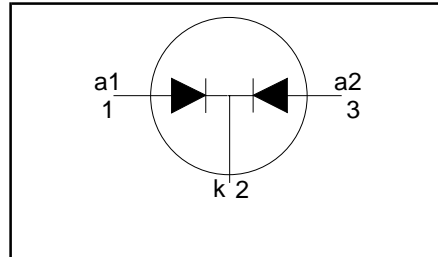

**QUICK REFERENCE DATA**

$V_R = 150\text{ V} / 200\text{ V}$
$V_F \leq 0.85\text{ V}$
$I_{O(AV)} = 30\text{ A}$
$I_{RRM} = 0.2\text{ A}$
$t_{tr} \leq 28\text{ ns}$

**GENERAL DESCRIPTION**

Dual, ultra-fast, epitaxial rectifier diodes intended for use as output rectifiers in high frequency switched mode power supplies.

The BYV42E series is supplied in the SOT78 conventional leaded package.  
The BYV42EB series is supplied in the SOT404 surface mounting package.

**PINNING**

PIN	DESCRIPTION
1	anode 1 (a)
2	cathode (k) <sup>1</sup>
3	anode 2 (a)
tab	cathode (k)

**SOT78 (TO220AB)**

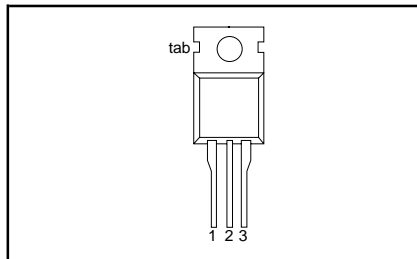

**SOT404**

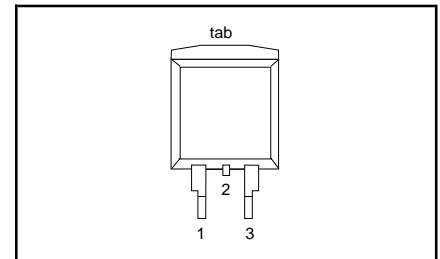

**LIMITING VALUES**

Limiting values in accordance with the Absolute Maximum System (IEC 134).

SYMBOL	PARAMETER	CONDITIONS	MIN.	MAX.		UNIT
				BYV42E / BYV42EB		
$V_{RRM}$	Peak repetitive reverse voltage	$T_{mb} \leq 144\text{ }^\circ\text{C}$	-	-150	-200	V
$V_{RWM}$	Crest working reverse voltage		-	150	200	V
$V_R$	Continuous reverse voltage		-	150	200	V
$I_{O(AV)}$	Average rectified output current (both diodes conducting)	square wave $\delta = 0.5; T_{mb} \leq 108\text{ }^\circ\text{C}$	-	30		A
$I_{FRM}$	Repetitive peak forward current per diode	$t = 25\text{ }\mu\text{s}; \delta = 0.5;$ $T_{mb} \leq 108\text{ }^\circ\text{C}$	-	30		A
$I_{FSM}$	Non-repetitive peak forward current per diode	$t = 10\text{ ms}$	-	150		A
		$t = 8.3\text{ ms}$ sinusoidal; with reapplied	-	160		A
$I_{RRM}$	Repetitive peak reverse current per diode	$V_{RWM(max)}$ $t_p = 2\text{ }\mu\text{s}; \delta = 0.001$	-	0.2		A
$I_{RSM}$	Non-repetitive peak reverse current per diode	$t_p = 100\text{ }\mu\text{s}$	-	0.2		A
$T_{stg}$	Storage temperature		-40	150		$^\circ\text{C}$
$T_j$	Operating junction temperature		-	150		$^\circ\text{C}$

1. It is not possible to make connection to pin 2 of the SOT404 package  
2. SOT78 package, For output currents in excess of 20 A, the cathode connection should be made to the mounting tab.

**Rectifier diodes  
ultrafast, rugged**
**BYV42E, BYV42EB series**
**ESD LIMITING VALUE**

SYMBOL	PARAMETER	CONDITIONS	MIN.	MAX.	UNIT
$V_C$	Electrostatic discharge capacitor voltage	Human body model; $C = 250 \text{ pF}$ ; $R = 1.5 \text{ k}\Omega$	-	8	kV

**THERMAL RESISTANCES**

SYMBOL	PARAMETER	CONDITIONS	MIN.	TYP.	MAX.	UNIT
$R_{th \text{ j-mb}}$	Thermal resistance junction to mounting base	per diode	-	-	2.4	K/W
		both diodes	-	-	1.4	K/W
$R_{th \text{ j-a}}$	Thermal resistance junction to ambient	SOT78 package, in free air	-	60	-	K/W
		SOT404 and SOT428 packages, pcb mounted, minimum footprint, FR4 board	-	50	-	K/W

**ELECTRICAL CHARACTERISTICS**

 characteristics are per diode at  $T_j = 25 \text{ }^\circ\text{C}$  unless otherwise stated

SYMBOL	PARAMETER	CONDITIONS	MIN.	TYP.	MAX.	UNIT
$V_F$	Forward voltage	$I_F = 15 \text{ A}$ ; $T_j = 150 \text{ }^\circ\text{C}$	-	0.78	0.85	V
		$I_F = 15 \text{ A}$	-	0.95	1.05	V
		$I_F = 30 \text{ A}$	-	1.00	1.20	V
$I_R$	Reverse current	$V_R = V_{RWM}$ ; $T_j = 100 \text{ }^\circ\text{C}$	-	0.5	1	mA
		$V_R = V_{RWM}$	-	10	100	$\mu\text{A}$
$Q_s$	Reverse recovery charge	$I_F = 2 \text{ A}$ ; $V_R \geq 30 \text{ V}$ ; $-di_F/dt = 20 \text{ A}/\mu\text{s}$	-	6	15	nC
$t_{rr1}$	Reverse recovery time	$I_F = 1 \text{ A}$ ; $V_R \geq 30 \text{ V}$ ; $-di_F/dt = 100 \text{ A}/\mu\text{s}$	-	20	28	ns
$t_{rr2}$	Reverse recovery time	$I_F = 0.5 \text{ A}$ to $I_R = 1 \text{ A}$ ; $I_{rec} = 0.25 \text{ A}$	-	13	22	ns
$V_{fr}$	Forward recovery voltage	$I_F = 1 \text{ A}$ ; $di_F/dt = 10 \text{ A}/\mu\text{s}$	-	1	-	V

Rectifier diodes  
ultrafast, rugged

BYV42E, BYV42EB series

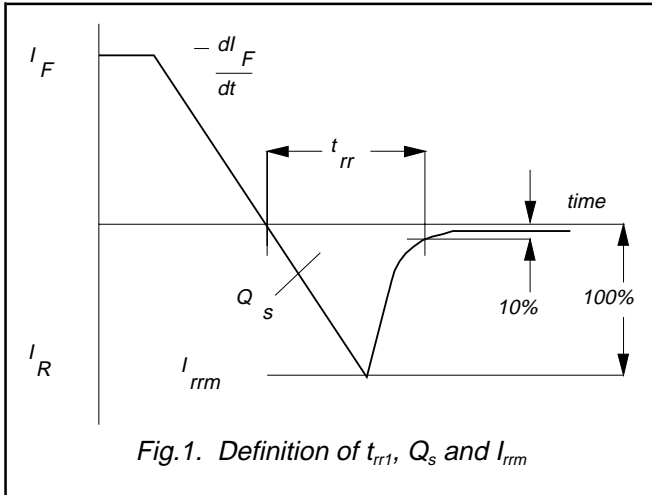

Fig.1. Definition of  $t_{rr}$ ,  $Q_s$  and  $I_{rm}$

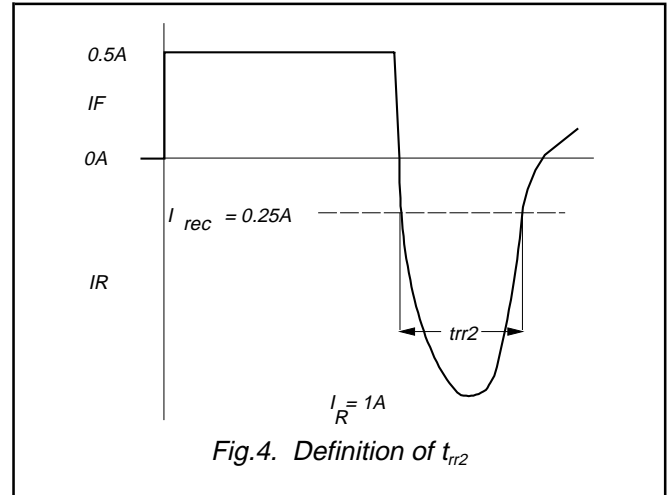

Fig.4. Definition of  $t_{rr2}$

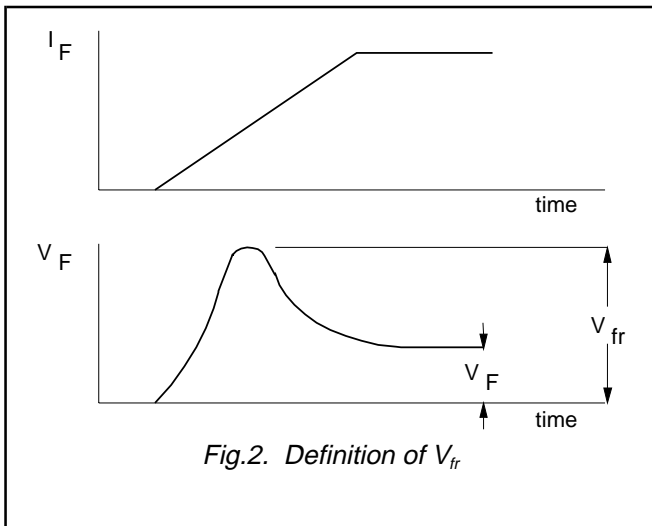

Fig.2. Definition of  $V_{fr}$

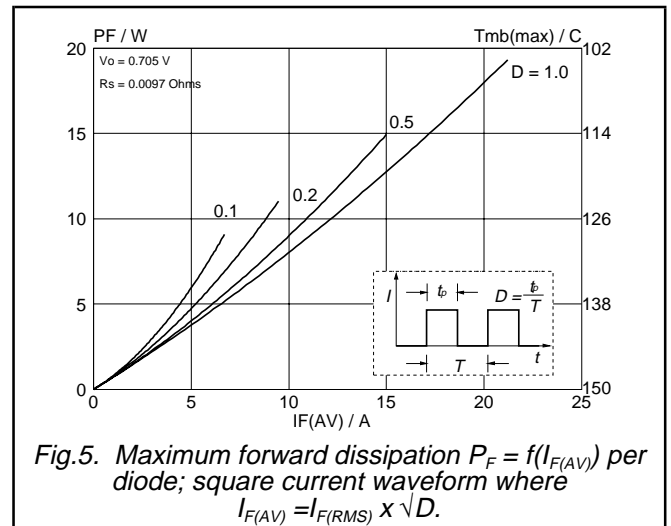

Fig.5. Maximum forward dissipation  $P_F = f(I_{F(AV)})$  per diode; square current waveform where  $I_{F(AV)} = I_{F(RMS)} \times \sqrt{D}$ .

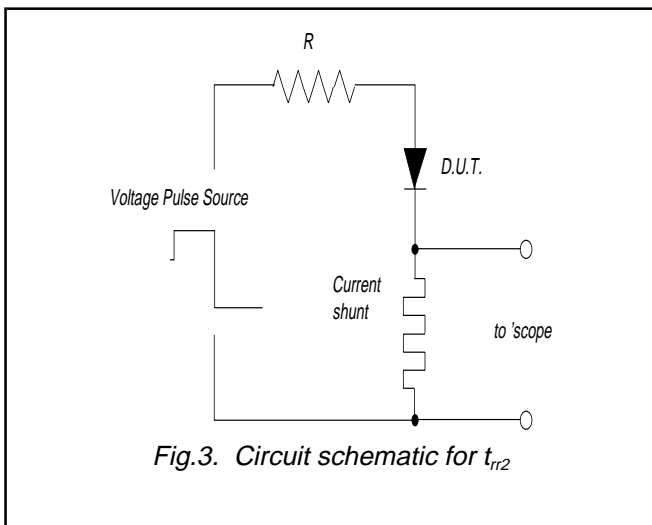

Fig.3. Circuit schematic for  $t_{rr2}$

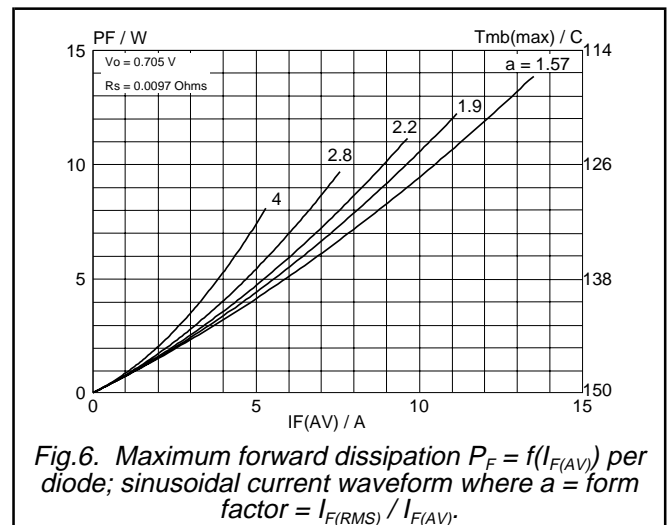
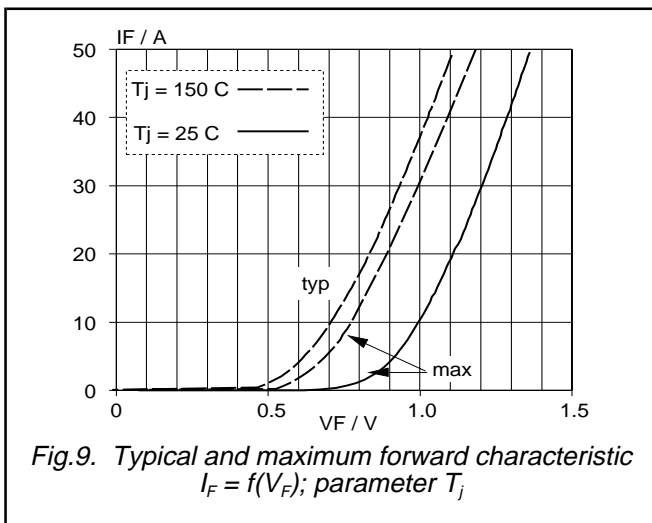
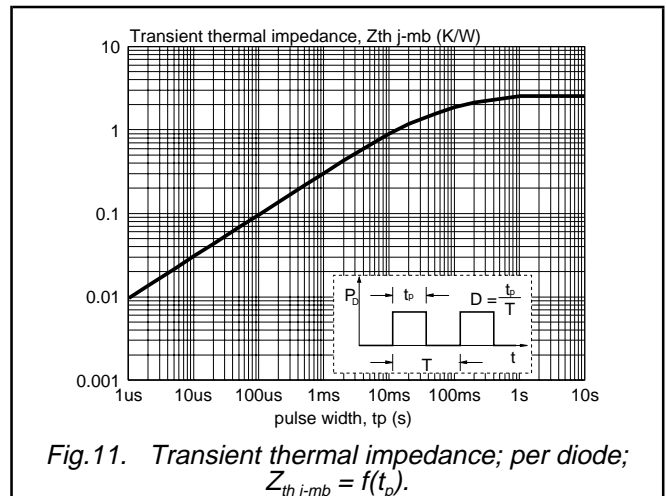
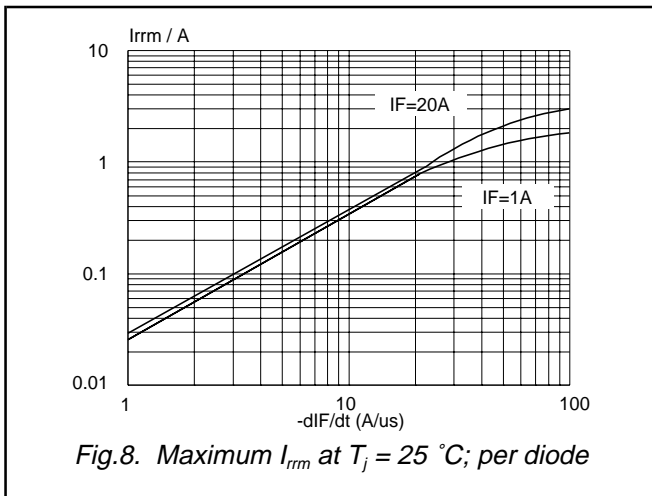
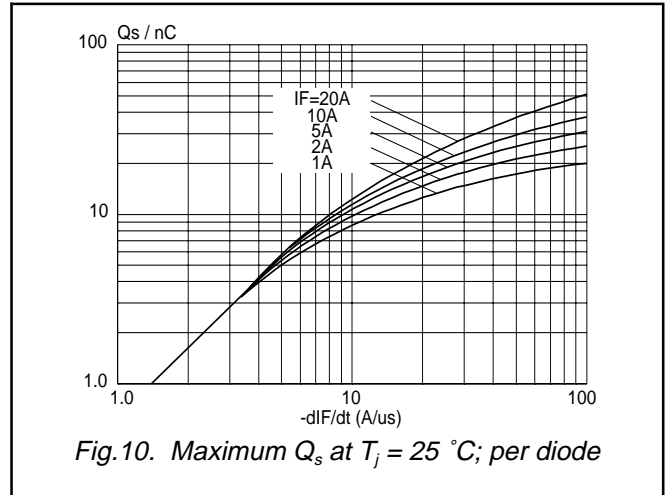
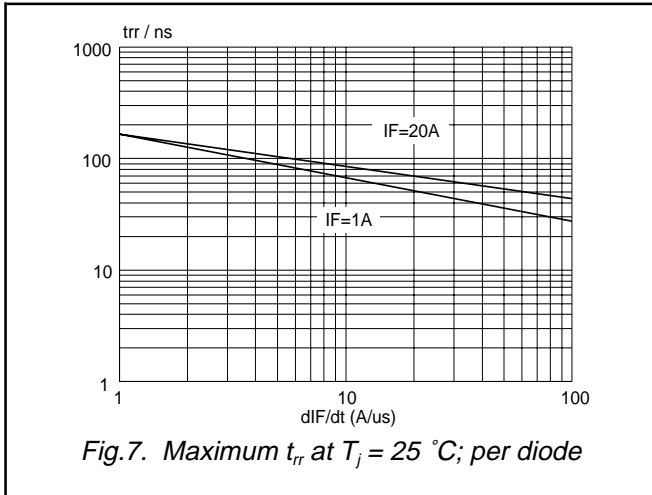

Fig.6. Maximum forward dissipation  $P_F = f(I_{F(AV)})$  per diode; sinusoidal current waveform where  $a = \text{form factor} = I_{F(RMS)} / I_{F(AV)}$ .

Rectifier diodes  
ultrafast, rugged

BYV42E, BYV42EB series



Rectifier diodes  
ultrafast, rugged

BYV42E, BYV42EB series

**MECHANICAL DATA**

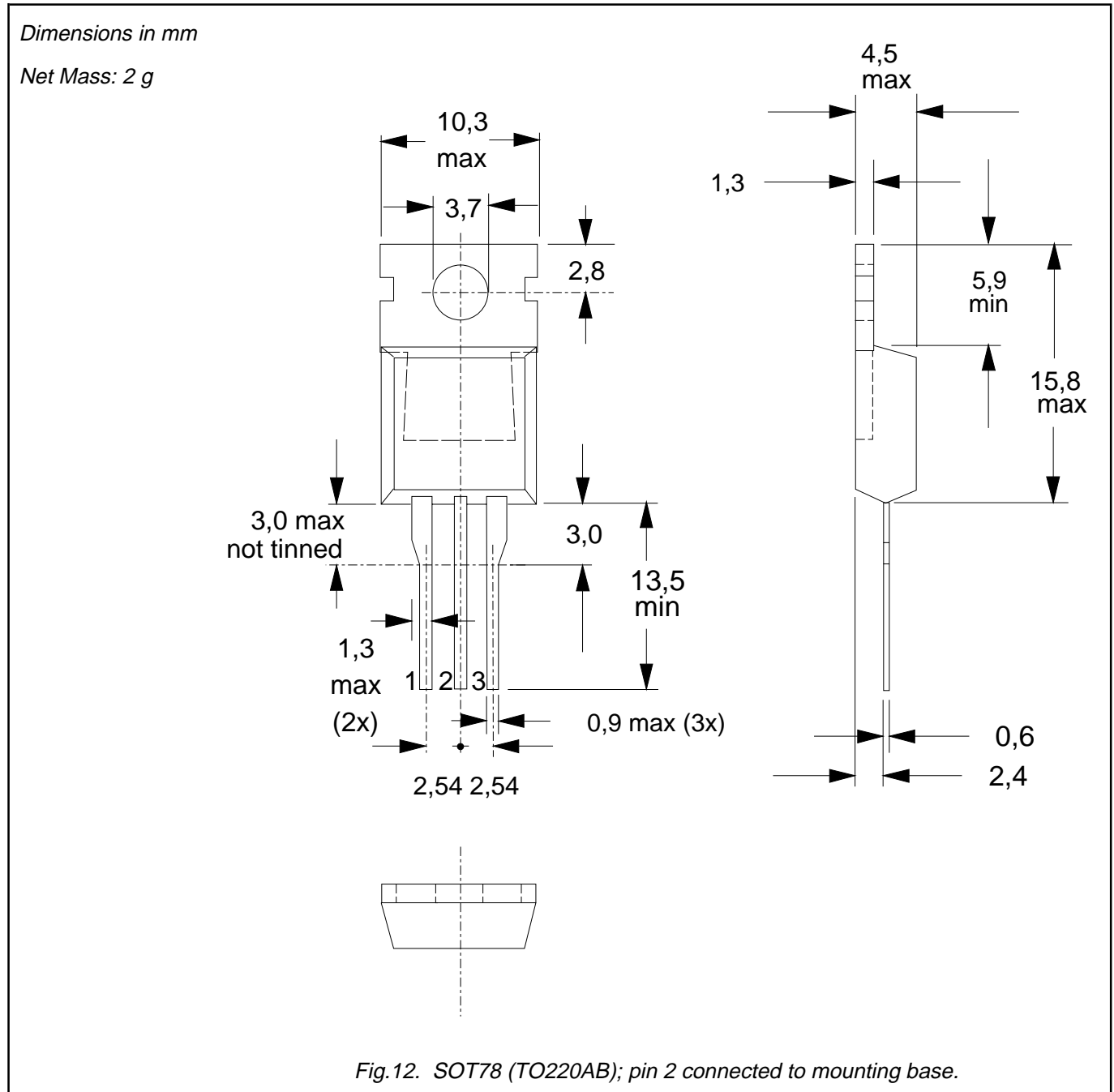

**Notes**

1. Refer to mounting instructions for SOT78 (TO220) envelopes.
2. Epoxy meets UL94 V0 at 1/8".

Rectifier diodes  
ultrafast, rugged

BYV42E, BYV42EB series

**MECHANICAL DATA**

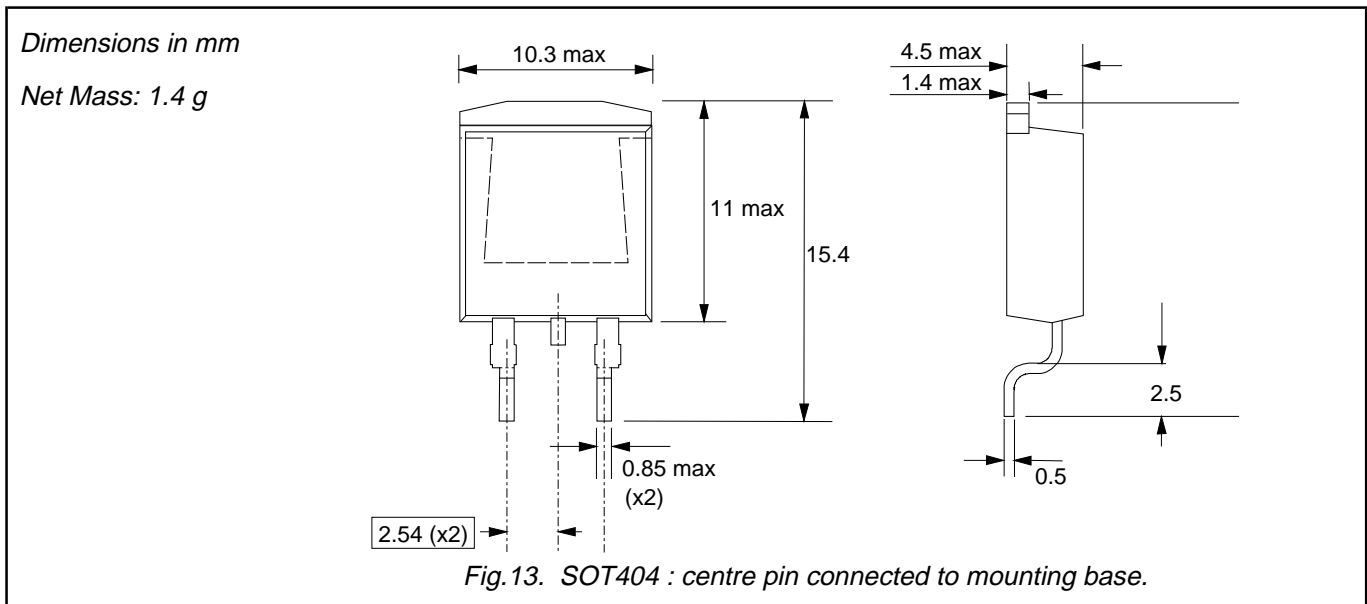

**MOUNTING INSTRUCTIONS**

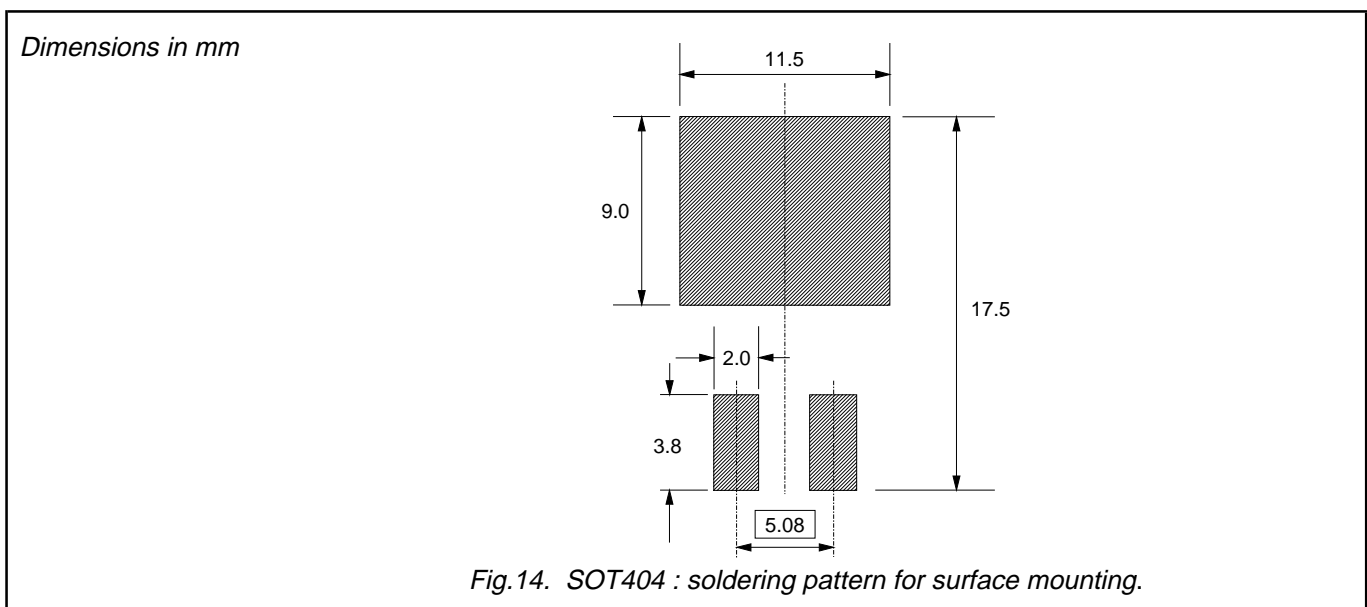

**Notes**

1. Epoxy meets UL94 V0 at 1/8".

Rectifier diodes  
ultrafast, rugged

BYV42E, BYV42EB series

## DEFINITIONS

<b>Data sheet status</b>	
Objective specification	This data sheet contains target or goal specifications for product development.
Preliminary specification	This data sheet contains preliminary data; supplementary data may be published later.
Product specification	This data sheet contains final product specifications.
<b>Limiting values</b>	
Limiting values are given in accordance with the Absolute Maximum Rating System (IEC 134). Stress above one or more of the limiting values may cause permanent damage to the device. These are stress ratings only and operation of the device at these or at any other conditions above those given in the Characteristics sections of this specification is not implied. Exposure to limiting values for extended periods may affect device reliability.	
<b>Application information</b>	
Where application information is given, it is advisory and does not form part of the specification.	
© Philips Electronics N.V. 1998	
All rights are reserved. Reproduction in whole or in part is prohibited without the prior written consent of the copyright owner.	
The information presented in this document does not form part of any quotation or contract, it is believed to be accurate and reliable and may be changed without notice. No liability will be accepted by the publisher for any consequence of its use. Publication thereof does not convey nor imply any license under patent or other industrial or intellectual property rights.	

## LIFE SUPPORT APPLICATIONS

These products are not designed for use in life support appliances, devices or systems where malfunction of these products can be reasonably expected to result in personal injury. Philips customers using or selling these products for use in such applications do so at their own risk and agree to fully indemnify Philips for any damages resulting from such improper use or sale.