

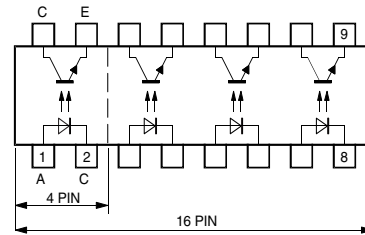

Optocoupler, Phototransistor Output, Single/Quad Channel, Half Pitch Mini-Flat Package

Features

- Low profile package (half pitch)
- AC Isolation test voltage 3750 V_{RMS}
- Low coupling capacitance of typical 0.3 pF
- **Current Transfer Ratio (CTR)** selected into groups
- Low temperature coefficient of CTR
- Wide ambient temperature range

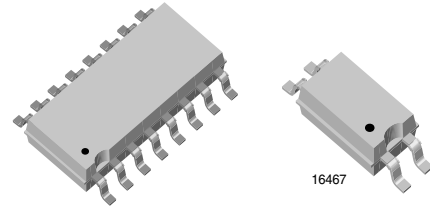

Agency Approvals

- UL File #E76222 System Code M
- C-UL CSA 22.2 bulletin 5A, Double Protection

Applications

Programmable logic controllers, modems, answering machines, general applications

Description

The TCMT11.. Series consist of a phototransistor optically coupled to a gallium arsenide infrared-emitting diode in an 4- pin (single channel) up to 16- pin (quad channel) package.

The elements are mounted on one leadframe providing a fixed distance between input and output for highest safety requirements.

Order Information

Part	Remarks
TCMT1100	CTR 50 - 600 %, SMD-4
TCMT1102	CTR 63 - 125 %, SMD-4
TCMT1103	CTR 100 - 200 %, SMD-4
TCMT1104	CTR 160 - 320 %, SMD-4
TCMT1105	CTR 50 - 150 %, SMD-4
TCMT1106	CTR 100 - 300 %, SMD-4
TCMT1107	CTR 80 - 160 %, SMD-4
TCMT1108	CTR 130 - 260 %, SMD-4
TCMT1109	CTR 200 - 400 %, SMD-4
TCMT4100	CTR 50 - 600 %, SMD-16

Absolute Maximum Ratings

$T_{amb} = 25\text{ }^{\circ}\text{C}$, unless otherwise specified

Stresses in excess of the absolute Maximum Ratings can cause permanent damage to the device. Functional operation of the device is not implied at these or any other conditions in excess of those given in the operational sections of this document. Exposure to absolute Maximum Rating for extended periods of the time can adversely affect reliability.

Input

Parameter	Test condition	Symbol	Value	Unit
Reverse voltage		V_R	6	V
Forward current		I_F	60	mA
Forward surge current	$t_p \leq 10\ \mu\text{s}$	I_{FSM}	1.5	A
Power dissipation		P_{diss}	100	mW
Junction temperature		T_j	125	$^{\circ}\text{C}$

Output

Parameter	Test condition	Symbol	Value	Unit
Collector emitter voltage		V_{CEO}	70	V
Emitter collector voltage		V_{ECO}	7	V
Collector current		I_C	50	mA
Peak collector current	$t_p/T = 0.5, t_p \leq 10\ \text{ms}$	I_{CM}	100	mA
Power dissipation		P_{diss}	150	mW
Junction temperature		T_j	125	$^{\circ}\text{C}$

Coupler

Parameter	Test condition	Symbol	Value	Unit
AC isolation test voltage (RMS)	Related to standard climate 23/50 DIN 50014	V_{ISO}	3750	V_{RMS}
Total power dissipation		P_{tot}	250	mW
Operating ambient temperature range		T_{amb}	- 40 to + 100	$^{\circ}\text{C}$
Storage temperature range		T_{stg}	- 40 to + 100	$^{\circ}\text{C}$
Soldering temperature		T_{sld}	235	$^{\circ}\text{C}$

Electrical Characteristics

$T_{amb} = 25\text{ }^{\circ}\text{C}$, unless otherwise specified

Minimum and maximum values are testing requirements. Typical values are characteristics of the device and are the result of engineering evaluation. Typical values are for information only and are not part of the testing requirements.

Input

Parameter	Test condition	Symbol	Min	Typ.	Max	Unit
Forward voltage	$I_F = 50\ \text{mA}$	V_F		1.25	1.6	V
Junction capacitance	$V_R = 0\ \text{V}, f = 1\ \text{MHz}$	C_j		50		pF



Output

Parameter	Test condition	Symbol	Min	Typ.	Max	Unit
Collector emitter voltage	$I_C = 100 \mu\text{A}$	V_{CEO}	70			V
Emitter collector voltage	$I_E = 100 \mu\text{A}$	V_{ECO}	7			V
Collector dark current	$V_{CE} = 20 \text{ V}, I_F = 0, E = 0$	I_{CEO}			100	nA

Coupler

Parameter	Test condition	Symbol	Min	Typ.	Max	Unit
Collector emitter saturation voltage	$I_F = 10 \text{ mA}, I_C = 1 \text{ mA}$	V_{CEsat}			0.3	V
Cut-off frequency	$I_F = 10 \text{ mA}, V_{CE} = 5 \text{ V}, R_L = 100 \Omega$	f_c		100		kHz
Coupling capacitance	$f = 1 \text{ MHz}$	C_k		0.3		pF

Current Transfer Ratio

Parameter	Test condition	Part	Symbol	Min	Typ.	Max	Unit
I_C/I_F	$V_{CE} = 5 \text{ V}, I_F = 5 \text{ mA}$	TCMT1100	CTR	50		600	%
		TCMT1102	CTR	53		125	%
			CTR	100		200	%
			CTR	160		320	%
	$V_{CE} = 5 \text{ V}, I_F = 5 \text{ mA}$	TCMT1105	CTR	50		150	%
		TCMT1106	CTR	100		300	%
		TCMT1107	CTR	80		160	%
		TCMT1108	CTR	130		260	%
		TCMT1109	CTR	200		400	%
		TCMT4100	CTR	50		600	%

Switching Characteristics

Parameter	Test condition	Symbol	Min	Typ.	Max	Unit
Delay time	$V_S = 5\text{ V}$, $I_C = 2\text{ mA}$, $R_L = 100\ \Omega$ (see figure 1)	t_d		3.0		μs
Rise time	$V_S = 5\text{ V}$, $I_C = 2\text{ mA}$, $R_L = 100\ \Omega$ (see figure 1)	t_r		3.0		μs
Fall time	$V_S = 5\text{ V}$, $I_C = 2\text{ mA}$, $R_L = 100\ \Omega$ (see figure 1)	t_f		4.7		μs
Storage time	$V_S = 5\text{ V}$, $I_C = 2\text{ mA}$, $R_L = 100\ \Omega$ (see figure 1)	t_s		0.3		μs
Turn-on time	$V_S = 5\text{ V}$, $I_C = 2\text{ mA}$, $R_L = 100\ \Omega$ (see figure 1)	t_{on}		6.0		μs
Turn-off time	$V_S = 5\text{ V}$, $I_C = 2\text{ mA}$, $R_L = 100\ \Omega$ (see figure 1)	t_{off}		5.0		μs
Turn-on time	$V_S = 5\text{ V}$, $I_F = 10\text{ mA}$, $R_L = 1\text{ k}\Omega$ (see figure 2)	t_{on}		9.0		μs
Turn-off time	$V_S = 5\text{ V}$, $I_F = 10\text{ mA}$, $R_L = 1\text{ k}\Omega$ (see figure 2)	t_{off}		18.0		μs

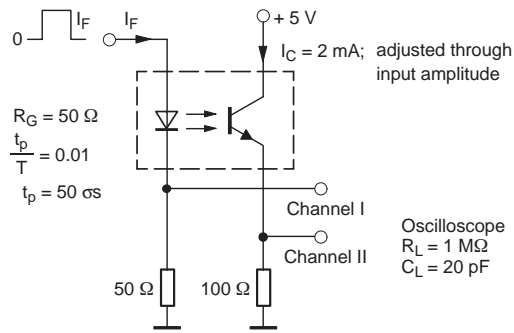

95 10804

Figure 1. Test circuit, non-saturated operation

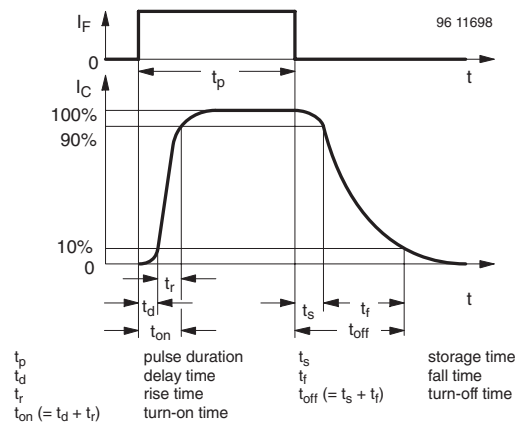
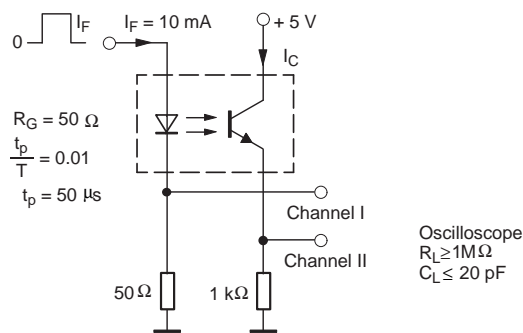

Figure 3. Switching times



95 10843

Figure 2. Test circuit, saturated operation

Typical Characteristics ($T_{amb} = 25\text{ }^{\circ}\text{C}$ unless otherwise specified)

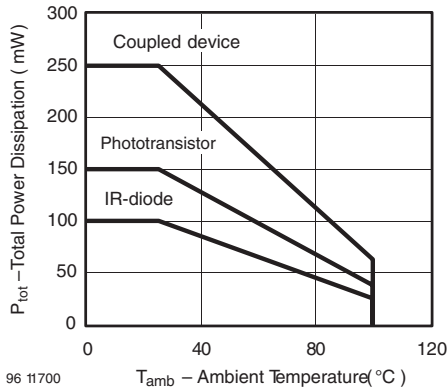

Figure 4. Total Power Dissipation vs. Ambient Temperature

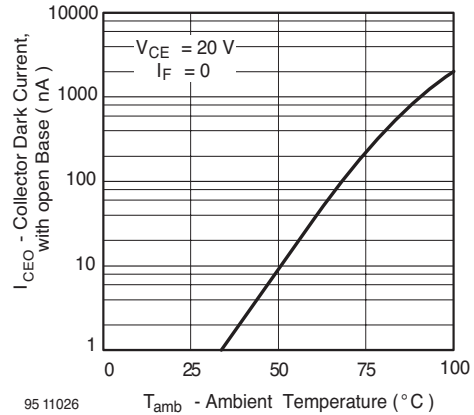

Figure 7. Collector Dark Current vs. Ambient Temperature

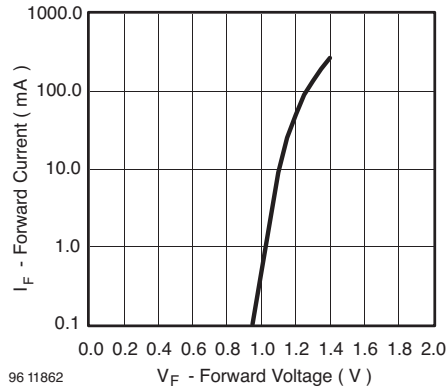

Figure 5. Forward Current vs. Forward Voltage

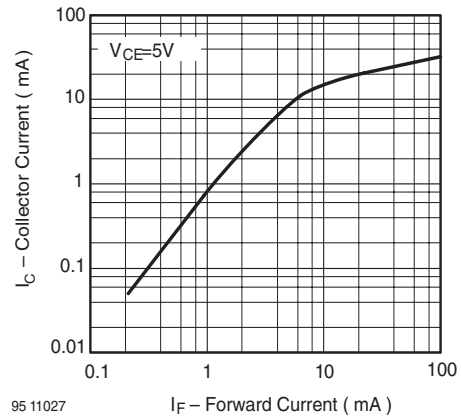

Figure 8. Collector Current vs. Forward Current

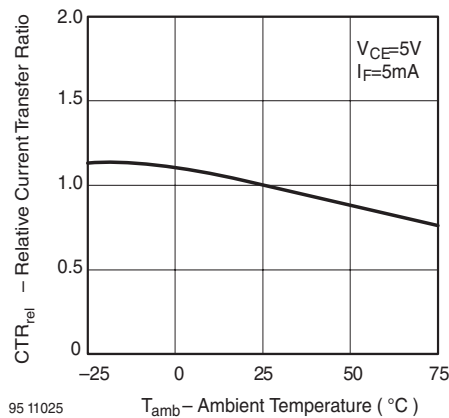

Figure 6. Relative Current Transfer Ratio vs. Ambient Temperature

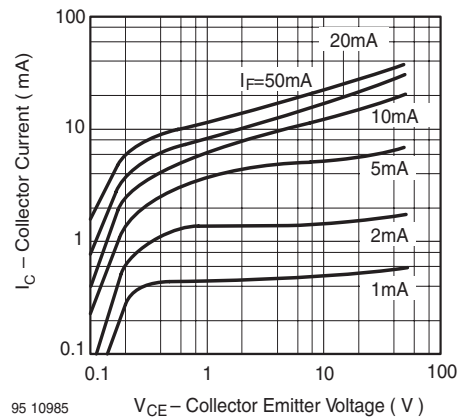

Figure 9. Collector Current vs. Collector Emitter Voltage

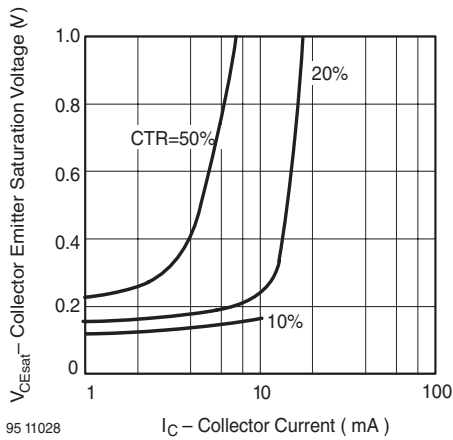

Figure 10. Collector Emitter Saturation Voltage vs. Collector Current

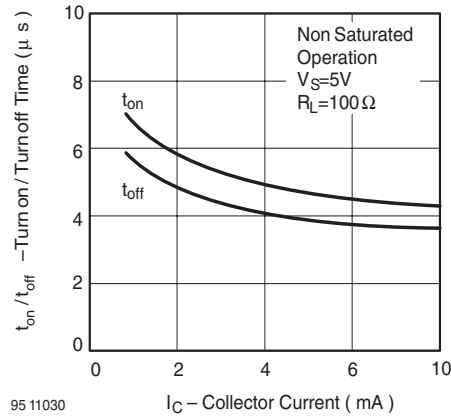

Figure 13. Turn on / off Time vs. Collector Current

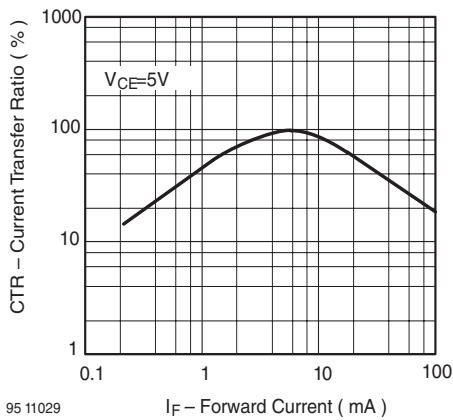

Figure 11. Current Transfer Ratio vs. Forward Current

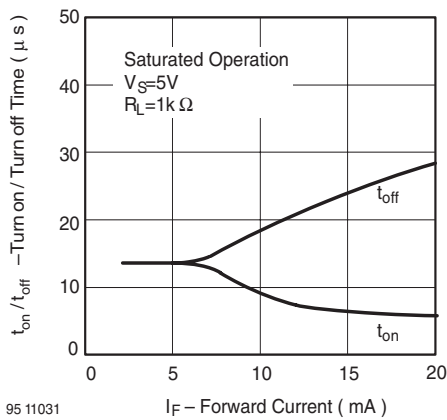
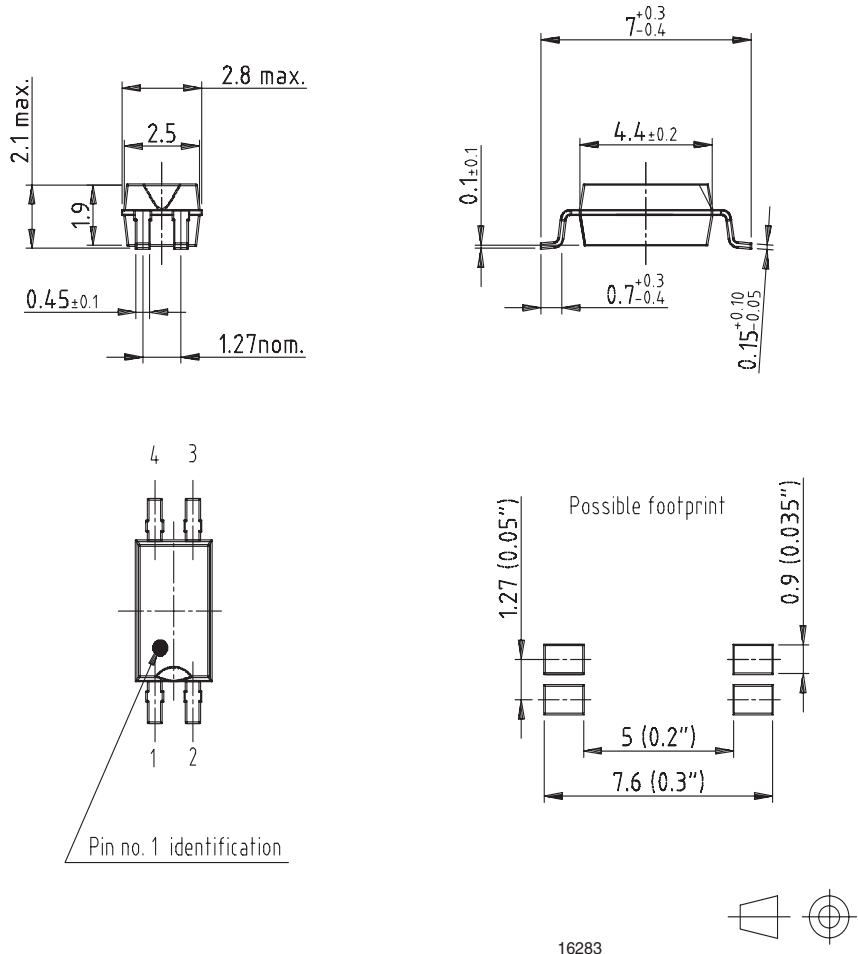

Figure 12. Turn on / off Time vs. Forward Current

Package Dimension of TCMT1... in mm



TCMT11.. Series/ TCMT4100



Vishay Semiconductors

Package Dimension of TCMT4...in mm

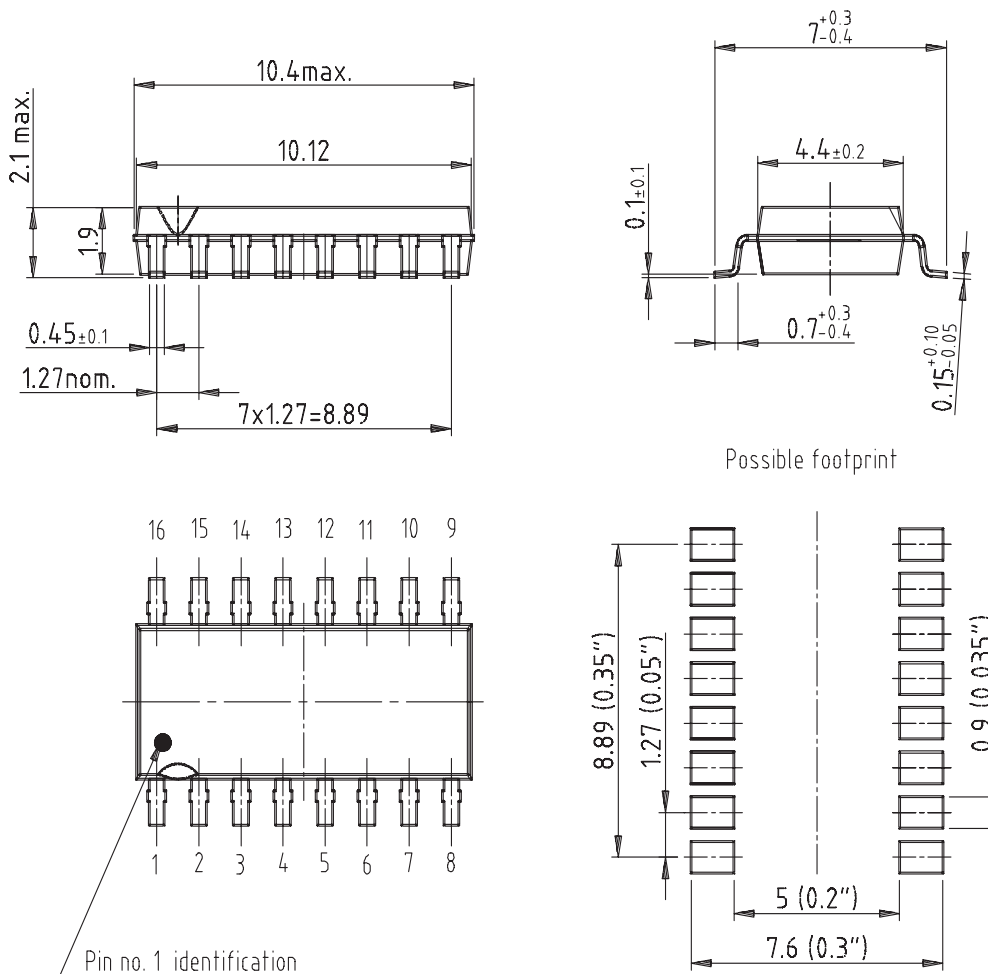

Drawing-No.: 6.544-5330.03-4
Issue: 1; 04.04.00

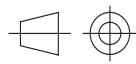
technical drawings
according to DIN
specifications

15226



Ozone Depleting Substances Policy Statement

It is the policy of **Vishay Semiconductor GmbH** to

1. Meet all present and future national and international statutory requirements.
2. Regularly and continuously improve the performance of our products, processes, distribution and operating systems with respect to their impact on the health and safety of our employees and the public, as well as their impact on the environment.

It is particular concern to control or eliminate releases of those substances into the atmosphere which are known as ozone depleting substances (ODSs).

The Montreal Protocol (1987) and its London Amendments (1990) intend to severely restrict the use of ODSs and forbid their use within the next ten years. Various national and international initiatives are pressing for an earlier ban on these substances.

Vishay Semiconductor GmbH has been able to use its policy of continuous improvements to eliminate the use of ODSs listed in the following documents.

1. Annex A, B and list of transitional substances of the Montreal Protocol and the London Amendments respectively
2. Class I and II ozone depleting substances in the Clean Air Act Amendments of 1990 by the Environmental Protection Agency (EPA) in the USA
3. Council Decision 88/540/EEC and 91/690/EEC Annex A, B and C (transitional substances) respectively.

Vishay Semiconductor GmbH can certify that our semiconductors are not manufactured with ozone depleting substances and do not contain such substances.

**We reserve the right to make changes to improve technical design
and may do so without further notice.**

Parameters can vary in different applications. All operating parameters must be validated for each customer application by the customer. Should the buyer use Vishay Semiconductors products for any unintended or unauthorized application, the buyer shall indemnify Vishay Semiconductors against all claims, costs, damages, and expenses, arising out of, directly or indirectly, any claim of personal damage, injury or death associated with such unintended or unauthorized use.

Vishay Semiconductor GmbH, P.O.B. 3535, D-74025 Heilbronn, Germany
Telephone: 49 (0)7131 67 2831, Fax number: 49 (0)7131 67 2423