

- ▼ Low Gate Charge
- ▼ Simple Drive Requirement
- ▼ Fast Switching

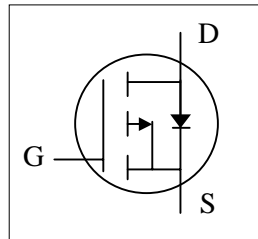

BV_{DSS}	-30V
$R_{DS(ON)}$	200m Ω
I_D	- 10A

Description

Advanced Power MOSFETs utilized advanced processing techniques to achieve the lowest possible on-resistance, extremely efficient and cost-effectiveness device.

The TO-252/TO-251 package is universally used for all commercial-industrial application.

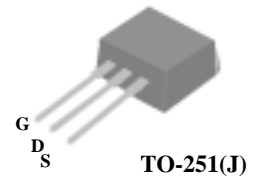
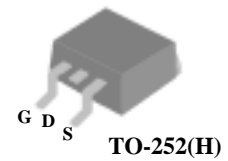

Absolute Maximum Ratings

Symbol	Parameter	Rating	Units
V_{DS}	Drain-Source Voltage	- 30	V
V_{GS}	Gate-Source Voltage	± 20	V
$I_D@T_A=25^\circ C$	Continuous Drain Current	-10	A
$I_D@T_A=70^\circ C$	Continuous Drain Current	-8.6	A
I_{DM}	Pulsed Drain Current ¹	-48	A
$P_D@T_A=25^\circ C$	Total Power Dissipation	36.7	W
	Linear Derating Factor	0.29	W/ $^\circ C$
T_{STG}	Storage Temperature Range	-55 to 150	$^\circ C$
T_J	Operating Junction Temperature Range	-55 to 150	$^\circ C$

Thermal Data

Symbol	Parameter	Value	Unit
Rthj-case	Thermal Resistance Junction-case	Max. 3.4	$^\circ C/W$
Rthj-amb	Thermal Resistance Junction-ambient	Max. 110	$^\circ C/W$



Electrical Characteristics @T_j=25°C(unless otherwise specified)

Symbol	Parameter	Test Conditions	Min.	Typ.	Max.	Units
BV _{DSS}	Drain-Source Breakdown Voltage	V _{GS} =0V, I _D =-250uA	-30	-	-	V
ΔBV _{DSS} /ΔT _j	Breakdown Voltage Temperature Coefficient	Reference to 25°C, I _D =-1mA	-	-0.1	-	V/°C
R _{DS(ON)}	Static Drain-Source On-Resistance ²	V _{GS} =-10V, I _D =-6A	-	-	200	mΩ
		V _{GS} =-4.5V, I _D =-4A	-	-	400	mΩ
V _{GS(th)}	Gate Threshold Voltage	V _{DS} =V _{GS} , I _D =-250uA	-1	-	-3	V
g _{fs}	Forward Transconductance	V _{DS} =-10V, I _D =-6A	-	2	-	S
I _{DSS}	Drain-Source Leakage Current (T _j =25°C)	V _{DS} =-30V, V _{GS} =0V	-	-	-1	uA
	Drain-Source Leakage Current (T _j =150°C)	V _{DS} =-24V, V _{GS} =0V	-	-	-25	uA
I _{GSS}	Gate-Source Leakage	V _{GS} = ± 20V	-	-	±100	nA
Q _g	Total Gate Charge ²	I _D =-6A	-	3.8	-	nC
Q _{gs}	Gate-Source Charge	V _{DS} =-15V	-	1.7	-	nC
Q _{gd}	Gate-Drain ("Miller") Charge	V _{GS} =-4.5V	-	1.6	-	nC
t _{d(on)}	Turn-on Delay Time ²	V _{DS} =-15V	-	6.7	-	ns
t _r	Rise Time	I _D =-6A	-	20.8	-	ns
t _{d(off)}	Turn-off Delay Time	R _G =2Ω, V _{GS} =-10V	-	14.9	-	ns
t _f	Fall Time	R _D =2.5Ω	-	4.4	-	ns
C _{iss}	Input Capacitance	V _{GS} =0V	-	217	-	pF
C _{oss}	Output Capacitance	V _{DS} =-25V	-	103	-	pF
C _{rss}	Reverse Transfer Capacitance	f=1.0MHz	-	31	-	pF

Source-Drain Diode

Symbol	Parameter	Test Conditions	Min.	Typ.	Max.	Units
V _{SD}	Forward On Voltage ²	I _S =-1.25A, V _{GS} =0V	-	-	-1.2	V
t _{rr}	Reverse Recovery Time	I _S =-6A, V _{GS} =0V,	-	35	-	ns
Q _{rr}	Reverse Recovery Charge	di/dt=-100A/μs	-	63	-	nC

Notes:

- 1.Pulse width limited by Max. junction temperature.
- 2.Pulse width ≤300us , duty cycle ≤2%.

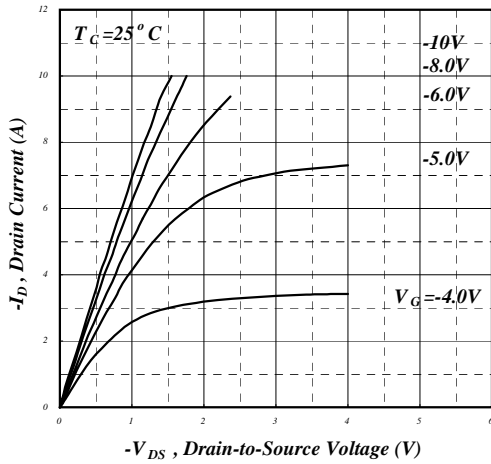

Fig 1. Typical Output Characteristics

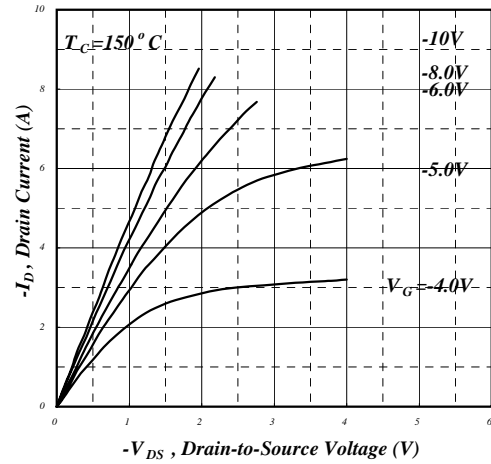

Fig 2. Typical Output Characteristics

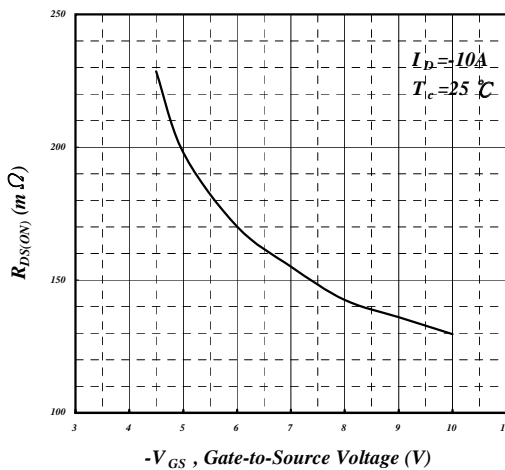

Fig 3. On-Resistance v.s. Gate Voltage

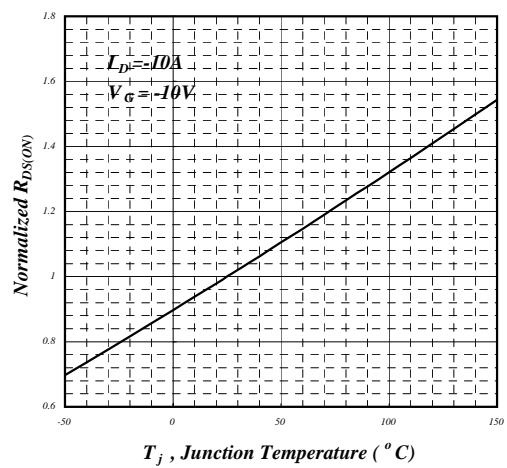

Fig 4. Normalized On-Resistance v.s. Junction Temperature

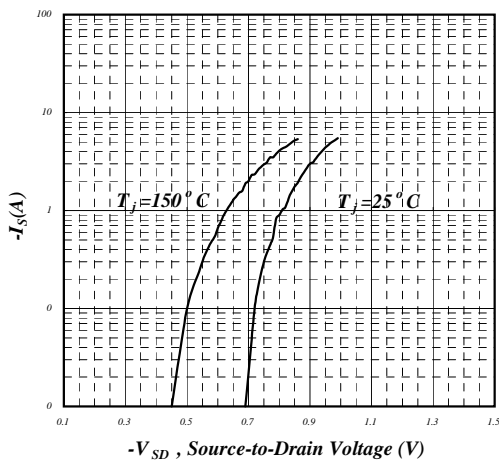

Fig 5. Forward Characteristic of Reverse Diode

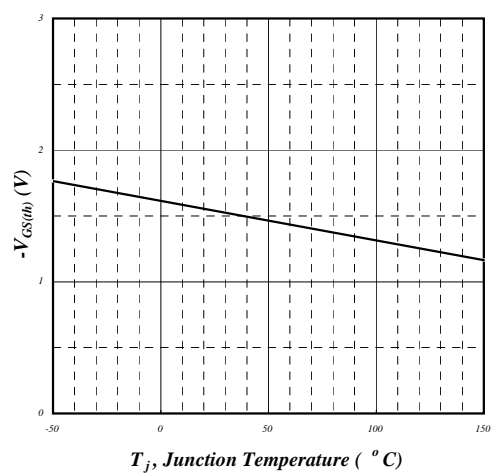

Fig 6. Gate Threshold Voltage v.s. Junction Temperature

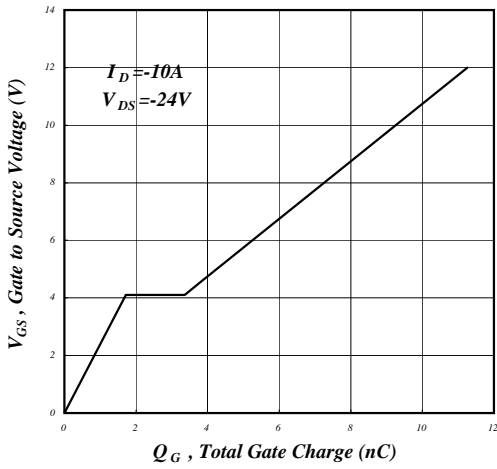

Fig 7. Gate Charge Characteristics

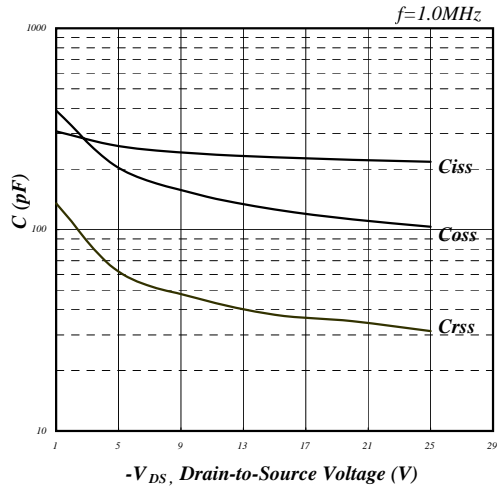

Fig 8. Typical Capacitance Characteristics

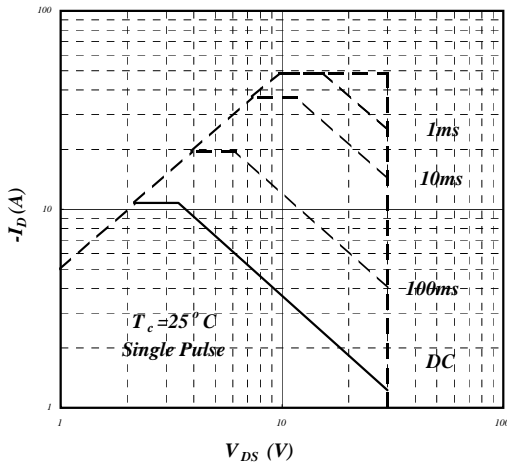

Fig 9. Maximum Safe Operating Area

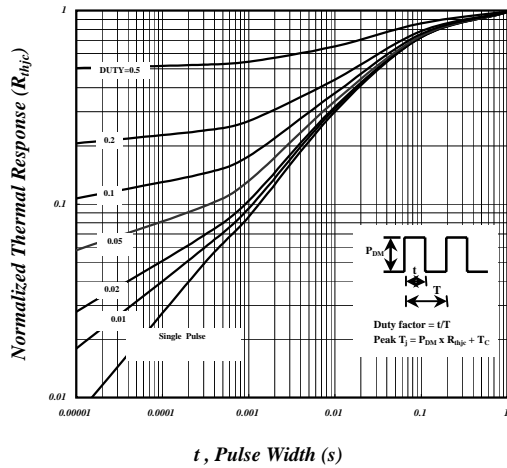

Fig 10. Effective Transient Thermal Impedance

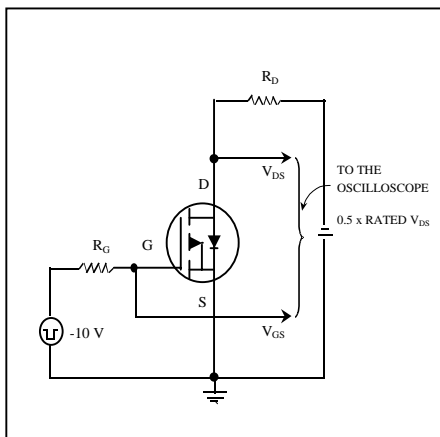

Fig11. Switching Time Circuit

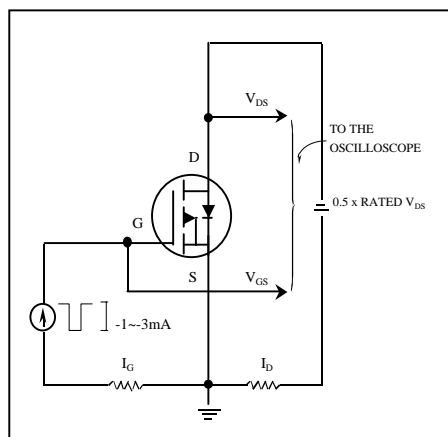

Fig 12. Gate Charge Circuit