

GP2S22

Subminiature Photointerrupter

■ Features

1. ϕ 4mm compact resin mold type
2. Focal distance: 0.6mm
3. Visible light cut-off type

■ Applications

1. Audio equipment
2. VCRs

■ Outline Dimensions

(Unit : mm)

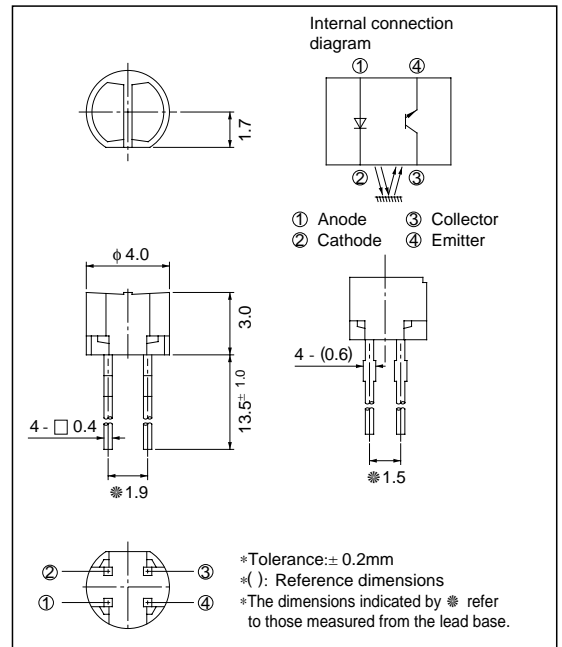

■ Absolute Maximum Ratings

(Ta = 25°C)

Parameter		Symbol	Rating	Unit
Input	Forward current	I_F	50	mA
	Reverse voltage	V_R	6	V
	Power dissipation	P	75	mW
Output	Collector-emitter voltage	V_{CEO}	35	V
	Emitter-collector voltage	V_{ECO}	6	V
	Collector current	I_C	20	mA
	Collector power dissipation	P_C	75	mW
Total power dissipation		P_{tot}	100	mW
Operating temperature		T_{opr}	- 25 to + 85	°C
Storage temperature		T_{sg}	- 40 to + 100	°C
*1 Soldering temperature		T_{sol}	260	°C

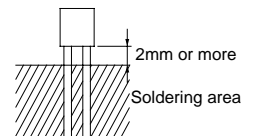

*1 For 3 seconds by manual soldering

Electro-optical Characteristics

($T_a = 25^\circ\text{C}$)

Parameter		Symbol	Conditions	MIN.	TYP.	MAX.	Unit	
Input	Forward voltage	V_F	$I_F = 20\text{mA}$	-	1.2	1.4	V	
	Reverse current	I_R	$V_R = 6\text{V}$	-	-	10	μA	
Output	Collector dark current	I_{CEO}	$V_{CE} = 20\text{V}, I_F = 0$	-	10^{-9}	10^{-7}	A	
Transfer characteristics	*2Collector current		I_C	$V_{CE} = 2\text{V}, I_F = 4\text{mA}$	20	-	125	μA
	Response time	Rise time	t_r	$V_{CE} = 2\text{V}, I_C = 100\mu\text{A}$ $R_L = 1\text{k}\Omega, d = 1\text{mm}$	-	20	100	μs
		Fall time	t_f		-	20	100	μs
	*3Leak current		I_{LEAK}	$V_{CE} = 2\text{V}, I_F = 4\text{mA}$	-	-	0.1	μA

*2 The condition and arrangement of the reflective object are shown in the following drawing.

*3 Without reflective object

The ranking of collector current shall be classified into the following 6 ranks.

Rank	$I_C (\mu\text{A})$
A	58 to 125
B	34 to 71
C	20 to 42
A or B	34 to 125
B or C	20 to 71
A, B or C	20 to 125

Test Condition and Arrangement for Collector Current

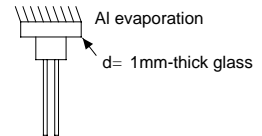

Fig. 1 Forward Current vs. Ambient Temperature

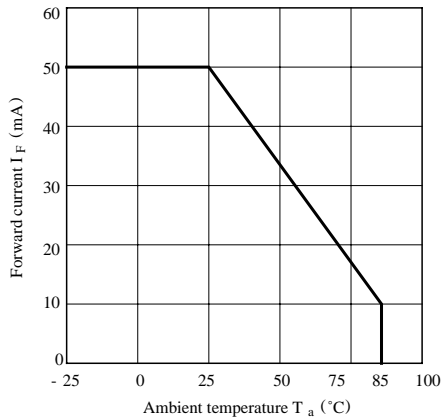

Fig. 2 Power Dissipation vs. Ambient Temperature

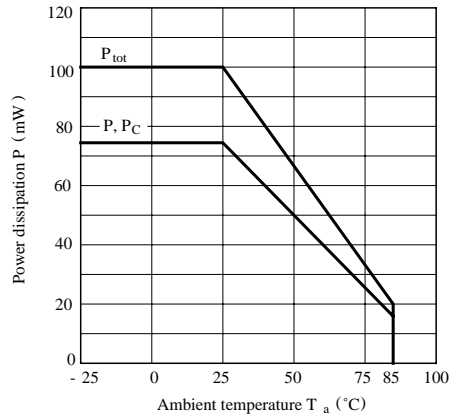

Fig.3 Forward Current vs. Forward Voltage

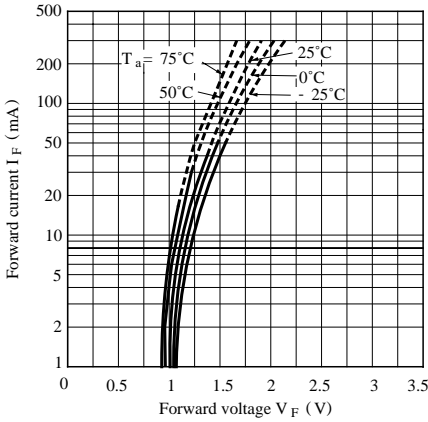

Fig.4 Collector Current vs. Forward Current

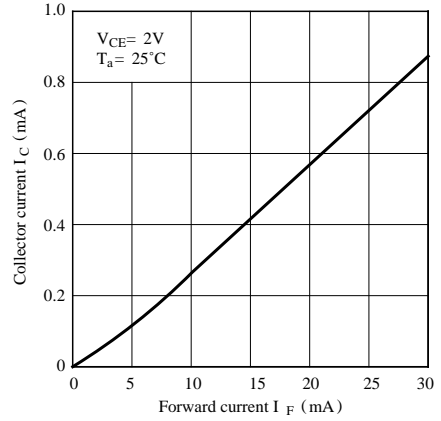

Fig. 5 Collector Current vs. Collector-emitter Voltage

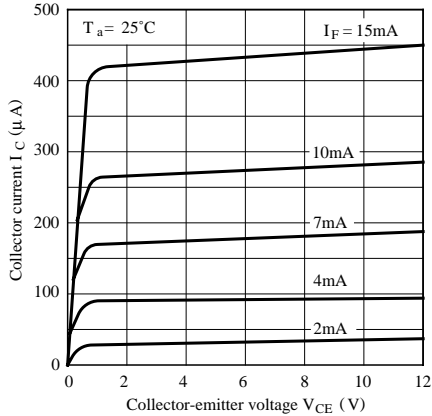

Fig. 6 Collector Current vs. Ambient Temperature

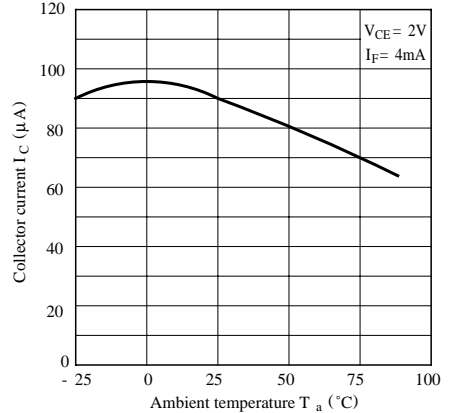

Fig. 7 Collector Dark Current vs. Ambient Temperature

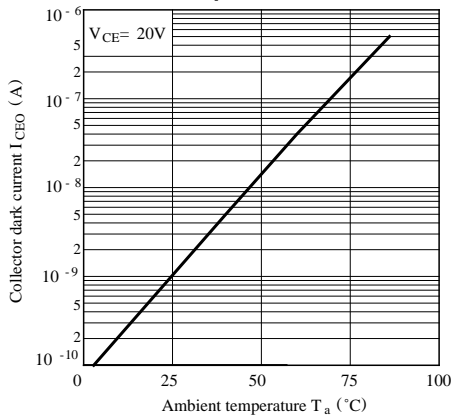
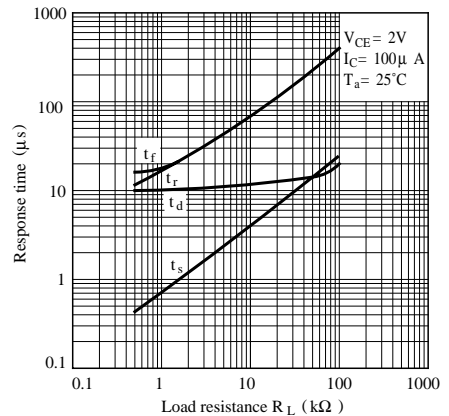

Fig. 8 Response Time vs. Load Resistance



Test Circuit for Response Time

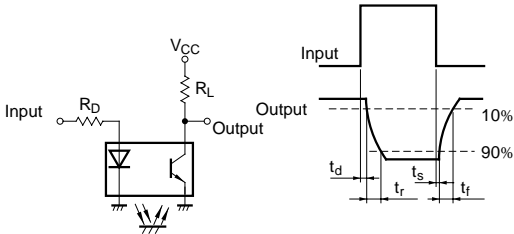
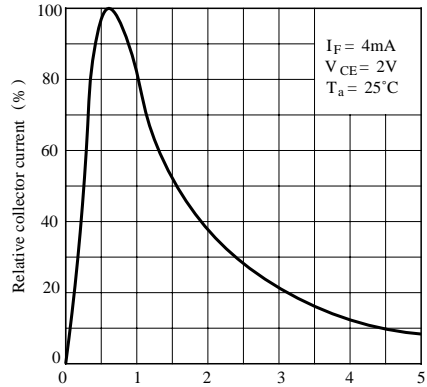
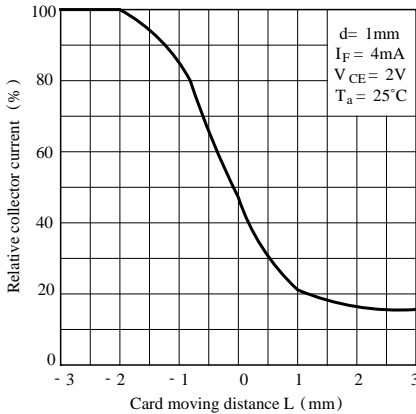

Fig. 9 Relative Collector Current vs. Distance between GP2S22 and Card



Distance between GP2S22 and test card d (mm)

Fig.10 Relative Collector Current vs. Card Moving Distance



Distance Characteristics Test Condition

Correspond to Fig.9

SHARP OMS TEST CARD (WHITE)



Correspond to Fig.10

SHARP OMS TEST CARD

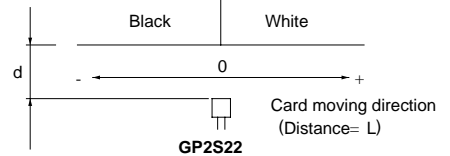

■ Precautions for Use

- (1) Perform soldering manually
- (2) Please refrain from soldering under preheating and refrain from soldering by reflow.
- (3) As for other general cautions, refer to the chapter “Precautions for Use”.