



2SA671

PNP EPITAXIAL SILICON TRANSISTOR

LOW FREQUENCY POWER AMPLIFIER

- Complement to 2SC1061

ABSOLUTE MAXIMUM RATINGS ($T_A=25^\circ\text{C}$)

Characteristic	Symbol	Rating	Unit
Collector-Base Voltage	V _{CB0}	-50	V
Collector-Emitter Voltage	V _{CE0}	-50	V
Emitter-Base voltage	V _{EB0}	-5	V
Collector Current (DC)	I _C	-3	A
Collector Dissipation ($T_c=25^\circ\text{C}$)	P _C	25	W
Junction Temperature	T _j	150	°C
Storage Temperature	T _{stg}	-50~150	°C

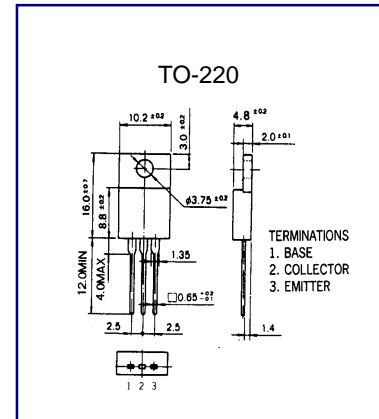

ELECTRICAL CHARACTERISTICS ($T_A=25^\circ\text{C}$)

Characteristic	Symbol	Test Condition	Min	Typ	Max	Unit
Collector Cutoff Current	I _{CBO}	V _{CB} =-50V, I _E =0			-10	μA
Emitter Cutoff Current	I _{EB0}	V _{EB} =-5V, I _C =0			10	μA
DC Current Gain	h _{FE1}	V _{CE} =-4V, I _C =-1A	35		200	
Collector- Emitter Saturation Voltage	V _{CE(sat)}	I _C =-3A, I _B =-0.3A			-1.0	V
Current Gain Bandwidth Product	f _T	V _{CE} =-2V, I _C =-0.5A		8		MHZ