

# AC05DGM to AC05FGM

## 5 A MOLD TRIAC

### PACKAGE DIMENSIONS (Unit: mm)

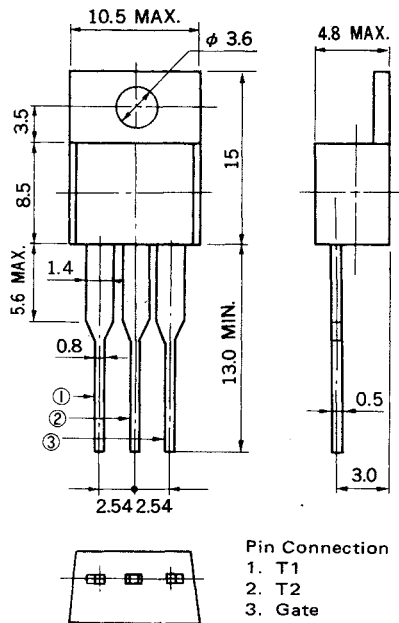

The AC05DGM to AC05FGM are all diffused mold type triac granted RMS On-state current 5 Amps, with rated voltages up to 600 volts.

### FEATURES

- 50 A Surge current
- TO-220AB mold package
- Low cost

### APPLICATIONS

- Motor speed control
- Lamp dimmer, Temperature controllers
- Various solid state switches, etc.

### MAXIMUM RATINGS

CHARACTERISTIC	SYMBOL	AC05DGM	AC05EGM	AC05FGM	UNIT	NOTE
Repetitive Peak off Voltage	$V_{DRM}$	400	500	600	V	
Non-repetitive Peak off Voltage	$V_{DSM}$	500	600	700	V	
RMS On-State Current	$I_T (RMS)$	5 ( $T_c = 107^\circ C$ )			A	See Fig. 11, 12
Peak Surge On-State Current	$I_{TSM}$	50 (50 Hz, Non-repetitive)			A	See Fig. 2
Fusing Current	$\int i^2 dt$	10 ( $1 ms \leq t \leq 10 ms$ )			$A^2 s$	
Peak Gate Power Dissipation	$P_{GM}$	3 ( $f \geq 50 Hz, Duty \leq 10\%$ )			W	
Average Gate Power Dissipation	$P_G (AV)$	0.3			W	
Peak Gate Current	$I_{FGM}$	$\pm 3$ ( $f \geq 50 Hz, Duty \leq 10\%$ )			A	
Junction Temperature	$T_j$	-40 to +125			$^\circ C$	
Storage Temperature	$T_{stg}$	-40 to +125			$^\circ C$	

ELECTRICAL CHARACTERISTICS ( $T_j = 25^\circ\text{C}$ )

CHARACTERISRIC	SYMBOL	TEST CONDITIONS	MIN.	TYP.	MAX.	UNIT	NOTE
Peak off-State Current	$I_{DRM}$	$T_j = 125^\circ\text{C}$ $V_{DM} = V_{DRM}$	—	—	1	mA	
On-State Voltage	$V_{TM}$	$I_{TM} = 5\text{ A}$	—	—	1.8	V	See Fig. 1
Gate Trigger Current	Trigger Mode I II III IV	$I_{GT}$ $V_{DM} = 12\text{ V}$ $R_L = 30\ \Omega$	—	—	10	mA	See Fig. 4
			—	—	—		
			—	—	10		
			—	—	10		
Gate Trigger Voltage	Trigger Mode I II III IV	$V_{GT}$ $V_{DM} = 12\text{ V}$ $R_L = 30\ \Omega$	—	—	1.5	V	See Fig. 4
			—	—	2.0		
			—	—	1.5		
			—	—	1.5		
Gate Non-Trigger Voltage	$V_{GD}$	$T_j = 125^\circ\text{C}$ , $V_{DM} = \frac{1}{2}V_{DRM}$	0.2	—	—	V	
Commutating dv/dt	$(dv/dt)\text{ C}$	$T_j = 125^\circ\text{C}$ $(di_T/dt)\text{ C} = -2.7\text{ A/ms}$ $V_D = 400\text{ V}$	5	—	—	V/ $\mu\text{s}$	
Holding Current	$I_H$	$V_D = 24\text{ V}$ , $I_{TM} = 5\text{ A}$	—	10	—	mA	
Thermal Resistance	$R_{th(j-c)}$	Junction to Case	—	—	3.0	$^\circ\text{C/W}$	See Fig. 13

Trigger Mode & Test Circuit

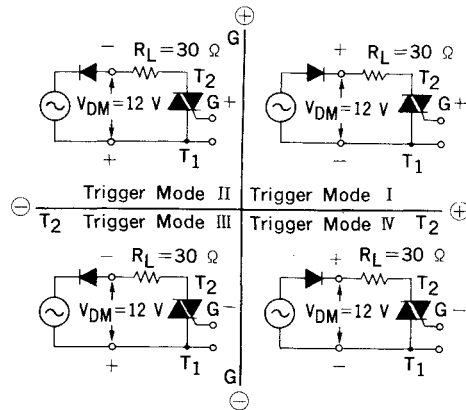

Fig. 1  $i_T - v_T$  CHARACTERISTIC

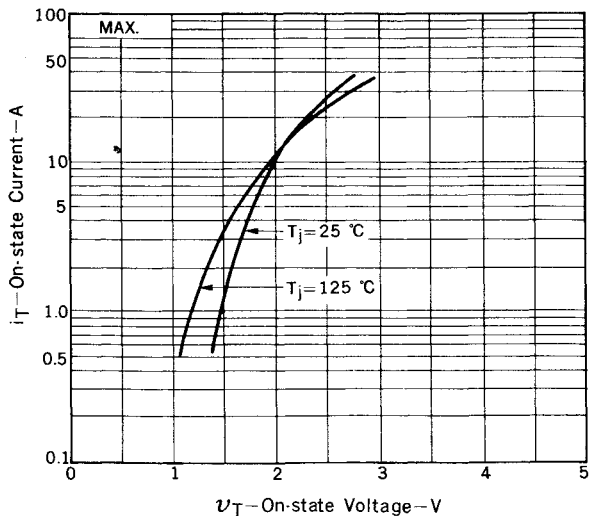

Fig. 2  $I_{TSM}$  RATING

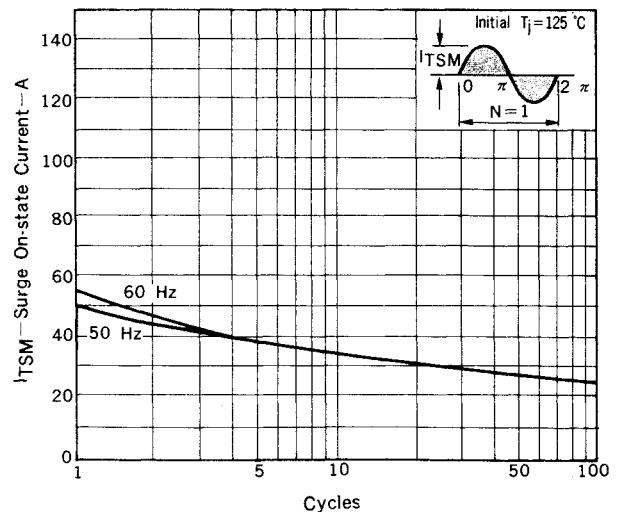

Fig. 3  $V_G - I_G$  RATING

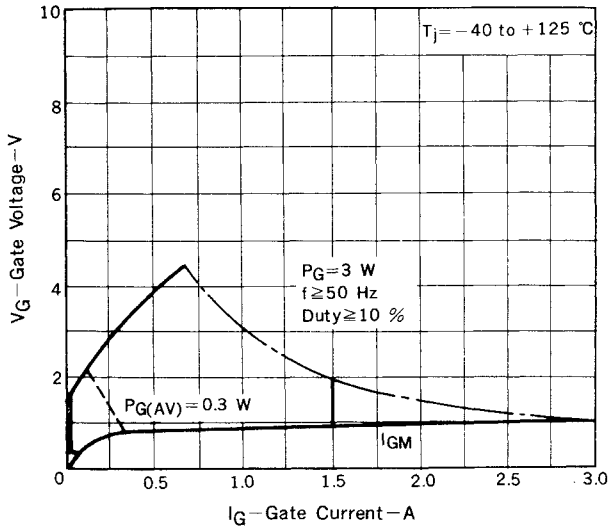

Fig. 4  $V_{GT} - I_{GT}$  CHARACTERISTIC

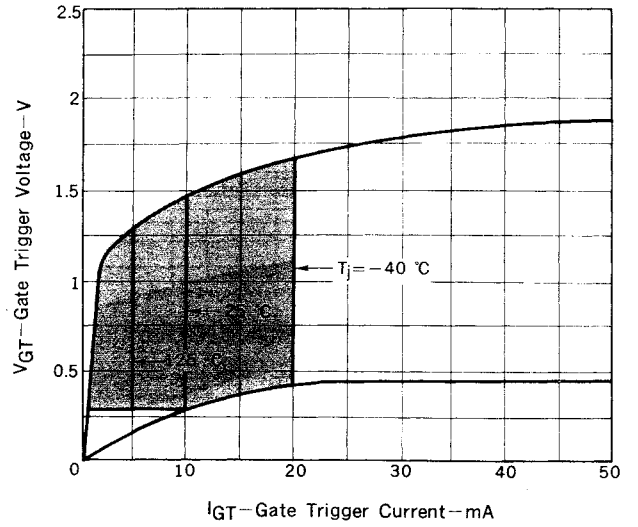

Fig. 5  $I_{GT} - T_a$  TYPICAL DISTRIBUTION

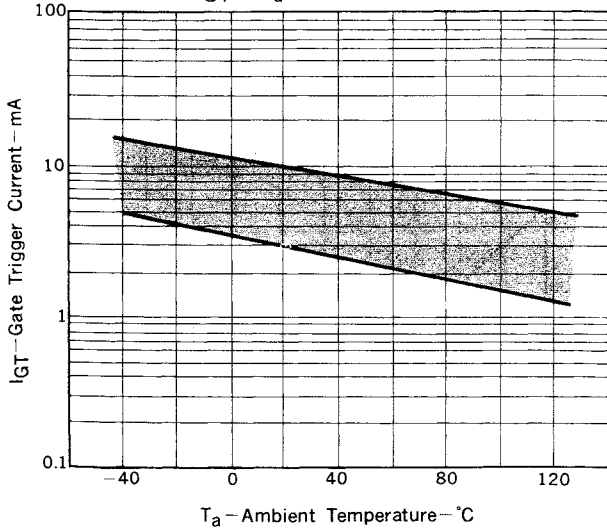

Fig. 6  $V_{GT} - T_a$  TYPICAL DISTRIBUTION

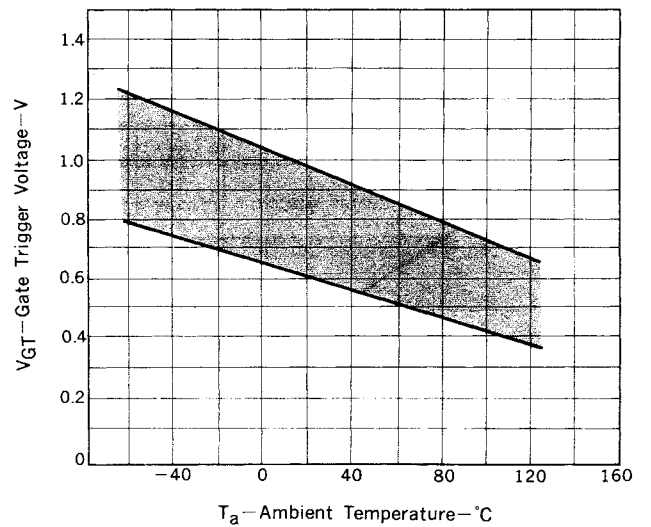

Fig. 7  $i_{GT} - \tau$  TYPICAL DISTRIBUTION

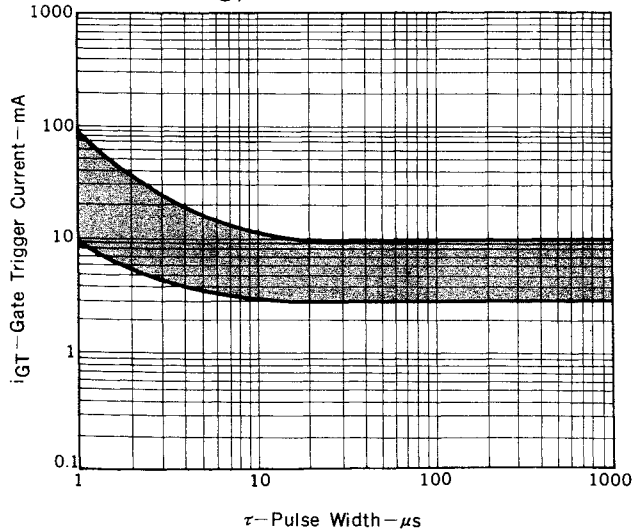

Fig. 8  $v_{GT} - \tau$  TYPICAL DISTRIBUTION

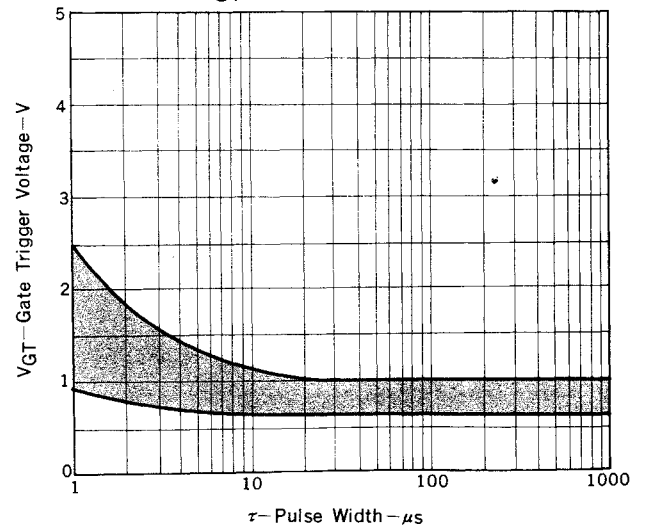

Fig. 9  $I_H - T_a$  TYPICAL DISTRIBUTION

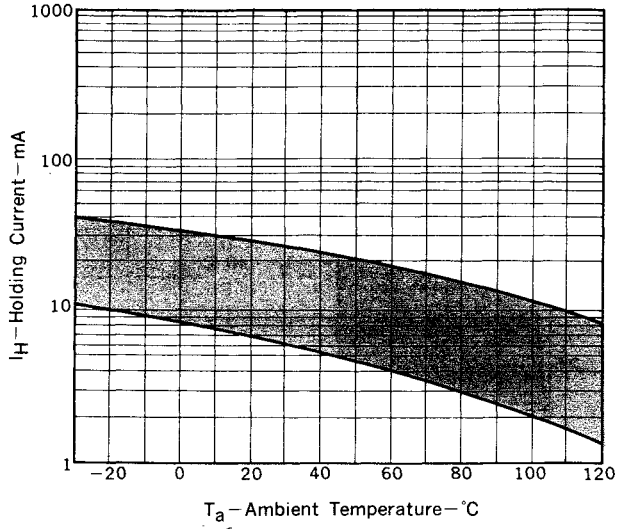

Fig. 10  $P_T(AV) - I_T(RMS)$  CHARACTERISTIC

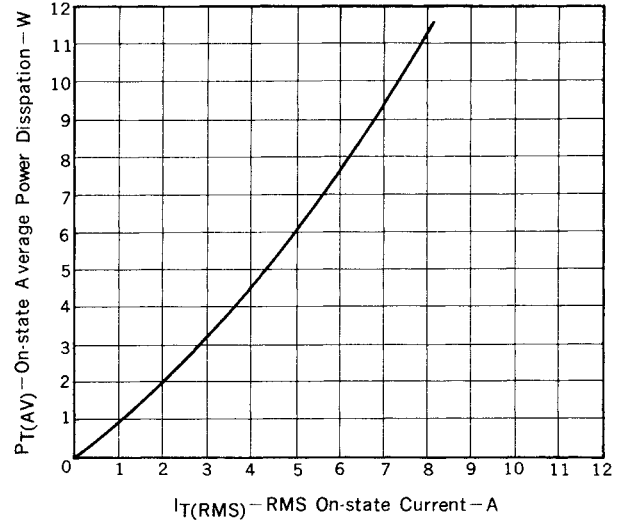

Fig. 11  $T_c - I_T(RMS)$  RATING

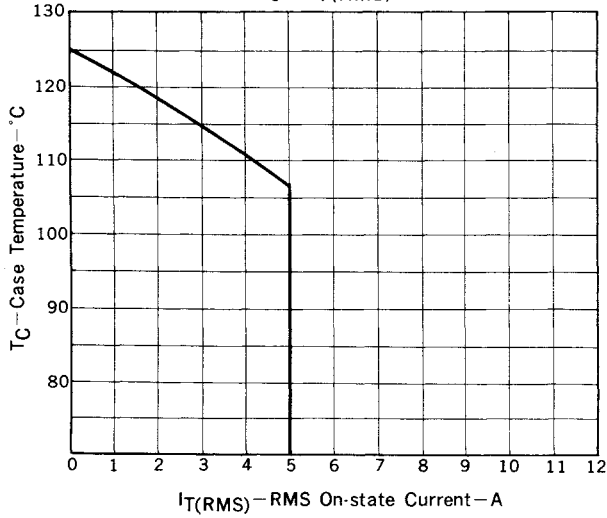

Fig. 12  $T_a - I_T(RMS)$  RATING

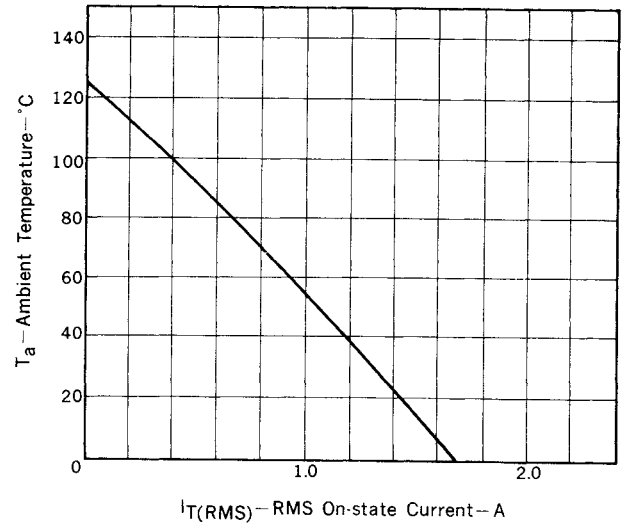
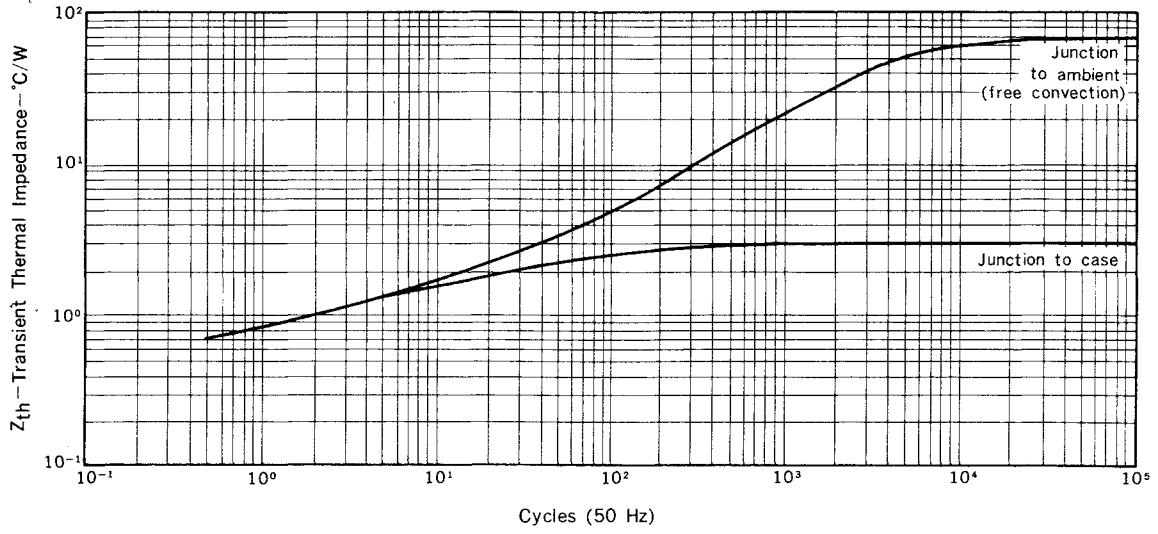

Fig. 13  $Z_{th}$  CHARACTERISTIC



---

## NEC Corporation

INTERNATIONAL ELECTRON DEVICES DIV.  
SUMITOMO MITA Building, 37-8,  
Shiba Gochome, Minato-ku, Tokyo 108, Japan  
Tel: Tokyo 456-3111  
Telex Address: NECTOK J22686  
Cable Address: NEC TOKYO

SC-1032  
APR.-25-85M  
Printed in Japan