

SBD Type : EA60QC03L

OUTLINE DRAWING

FEATURES

- * TO-251AA Case
- * Dual Diodes Cathode Common
- * Low Forward Voltage drop
- * Low Power Loss
- * High Surge Capability
- * 30 Volts thru 100 Volts Types Available

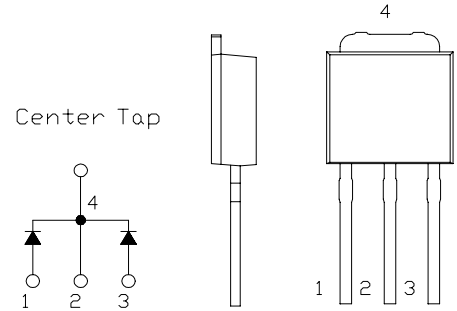

Maximum Ratings

Approx Net Weight:0.35g

Rating	Symbol	EA60QC03L			Unit
Repetitive Peak Reverse Voltage	V_{RRM}	30			V
Average Rectified Output Current	I_O	2.0	$T_a=20^{\circ}C$	50Hz Full Sine Wave Resistive Load	A
		6.0	$T_c=111^{\circ}C$		
RMS Forward Current	$I_{F(RMS)}$	6.66			A
Surge Forward Current	I_{FSM}	45	50Hz Full Sine Wave, 1cycle, Non-repetitive		A
Operating Junction Temperature Range	T_{jw}	- 40 to + 150			$^{\circ}C$
Storage Temperature Range	T_{stg}	- 40 to + 150			$^{\circ}C$

Electrical • Thermal Characteristics

Characteristics	Symbol	Conditions	Min	Typ	Max	Unit
Peak Reverse Current	I_{RM}	$T_j=25^{\circ}C, V_{RM}=V_{RRM}$ per Arm	-	-	3.0	mA
Peak Forward Voltage	V_{FM}	$T_j=25^{\circ}C, I_{FM}= 3 A$ per Arm	-	-	0.45	V
Thermal Resistance	Junction to Ambient	$R_{th(j-a)}$	P.C.Board mounted *		80	$^{\circ}C/W$
	Junction to Case	$R_{th(j-c)}$	-		5	$^{\circ}C/W$

* Print Land = 20x20 mm

EA60QC03L OUTLINE DRAWING (Dimensions in mm)

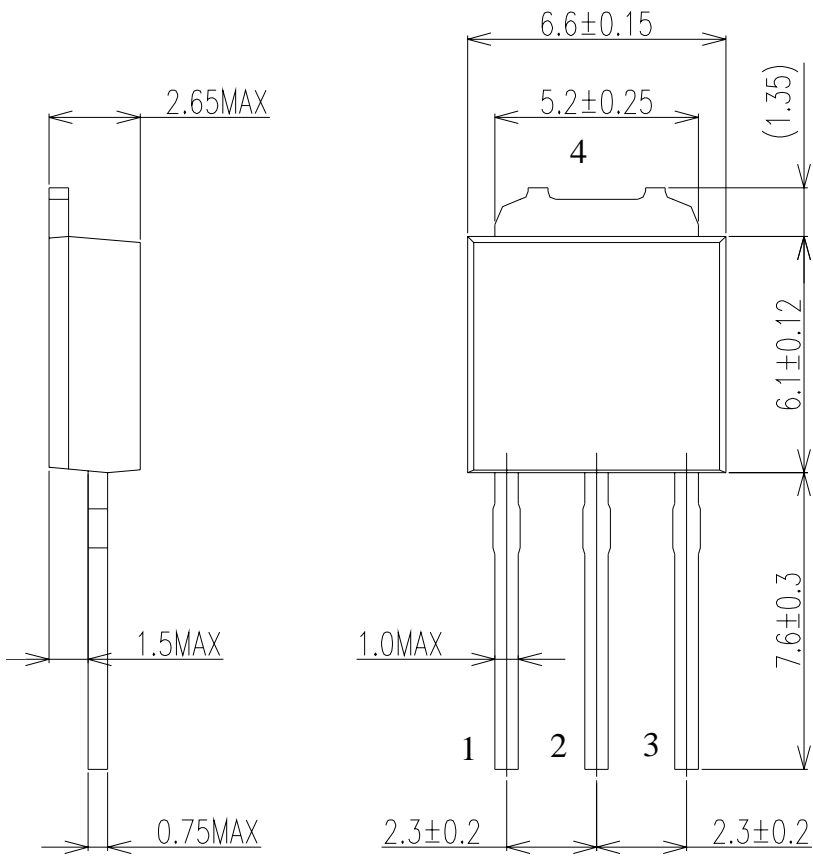

Center Tap

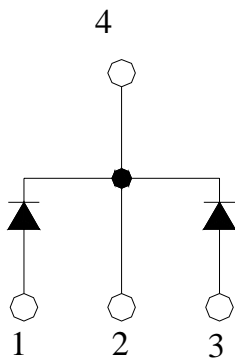

FORWARD CURRENT VS. VOLTAGE

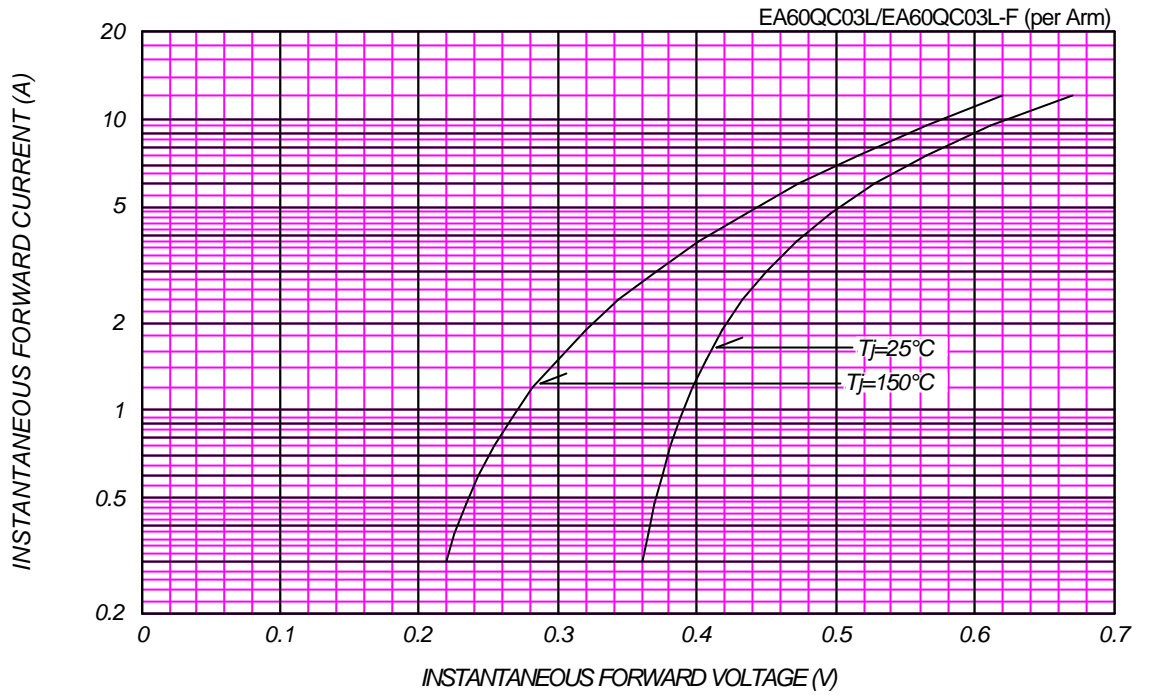

AVERAGE FORWARD POWER DISSIPATION

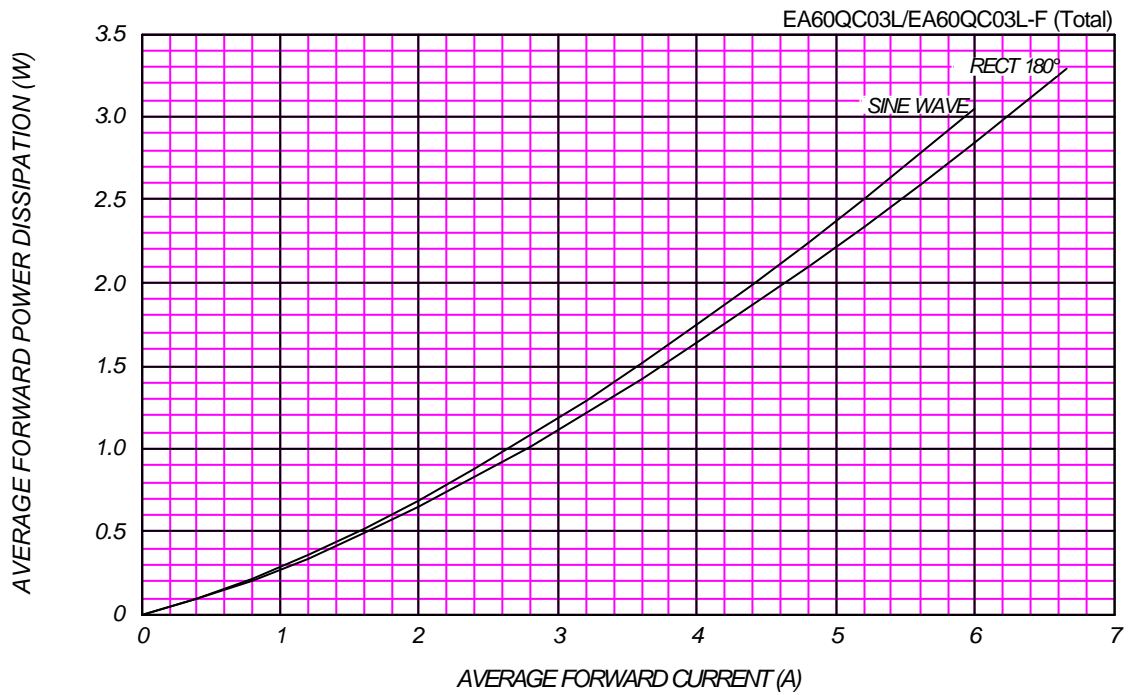

PEAK REVERSE CURRENT VS. PEAK REVERSE VOLTAGE

T_j = 150 °C

EA60QC03L/EA60QC03L-F (per Arm)

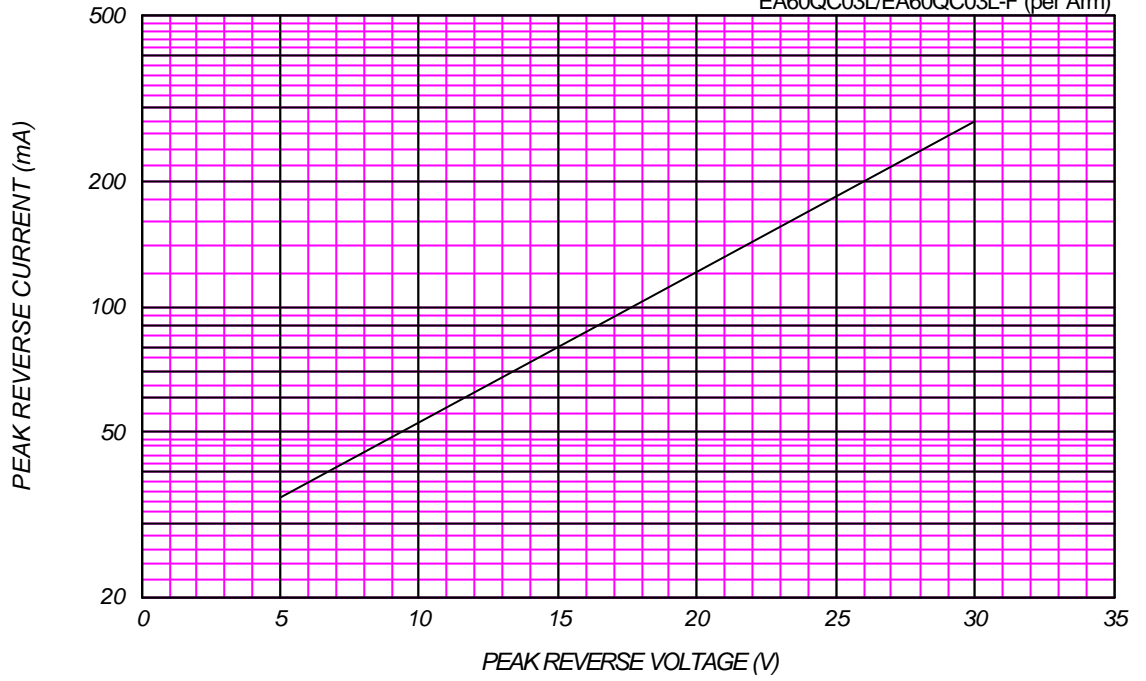

AVERAGE REVERSE POWER DISSIPATION

EA60QC03L/EA60QC03L-F (Total)

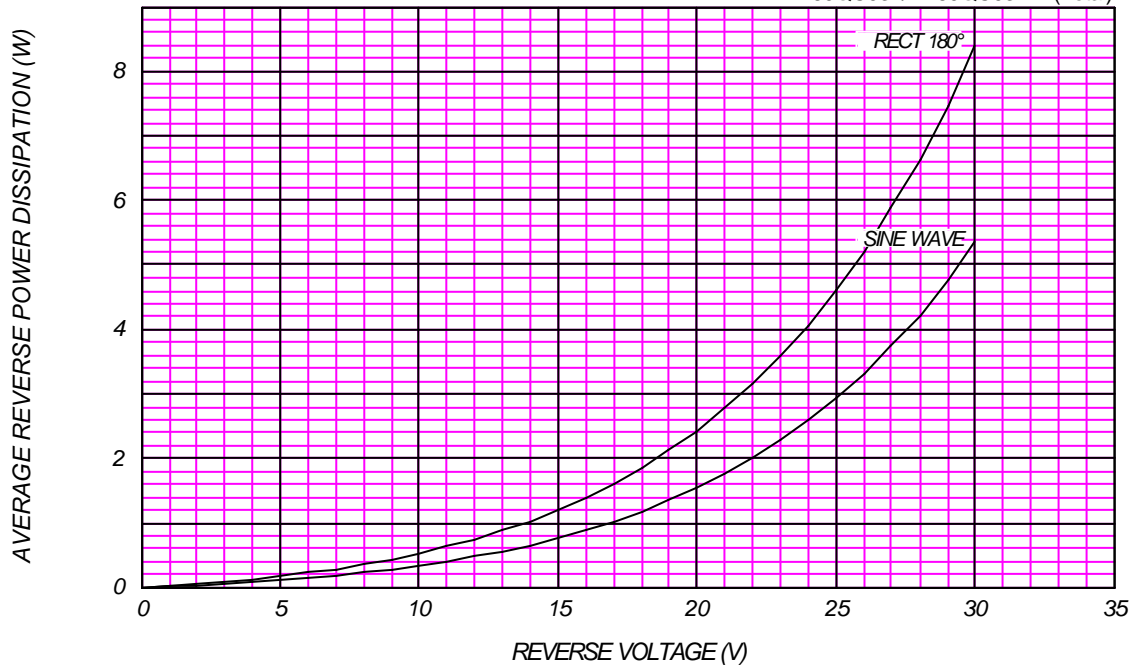



AVERAGE FORWARD CURRENT VS. CASE TEMPERATURE

$V_{RM}=30V$

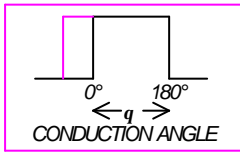
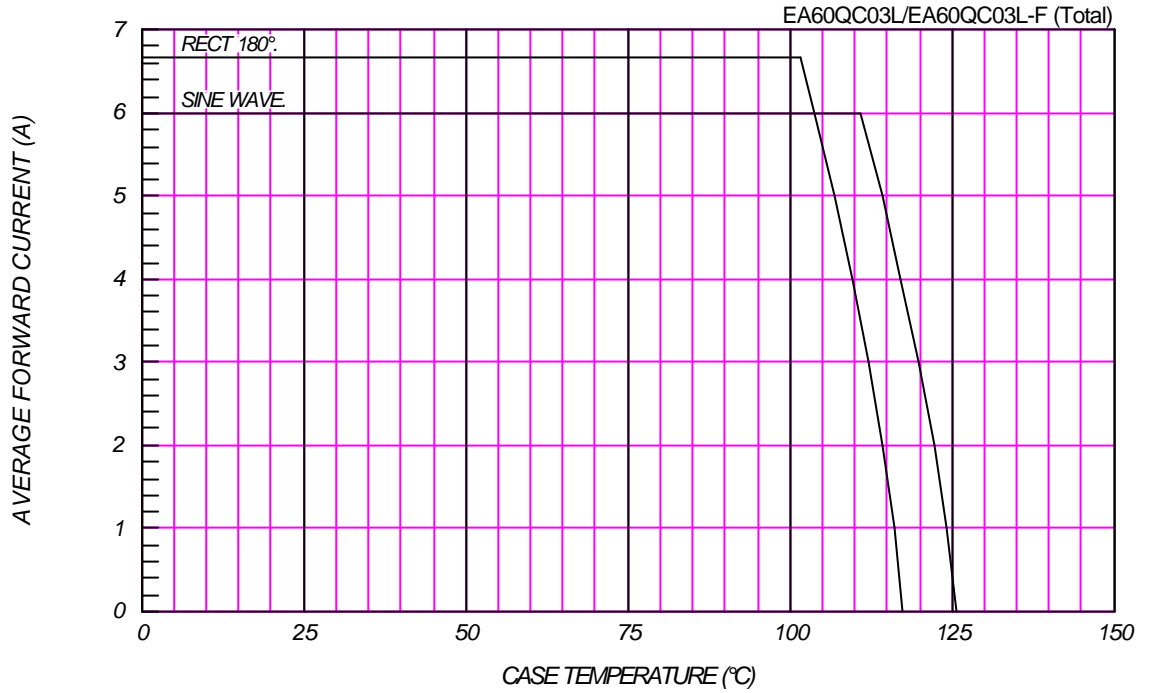

AVERAGE FORWARD CURRENT VS. AMBIENT TEMPERATURE

P.C. Board mounted (Plint land=20x20mm)

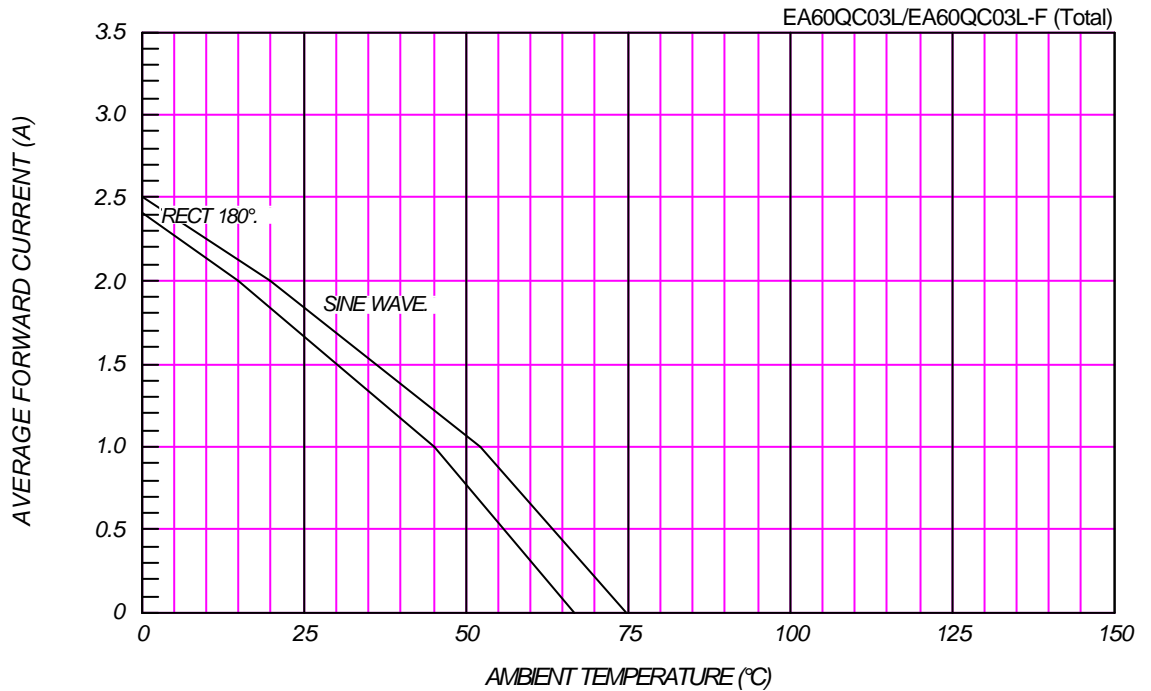

SURGE CURRENT RATINGS

f=50Hz,Sine Wave,Non-Repetitive,No Load

EA60QC03L/EA60QC03L-F

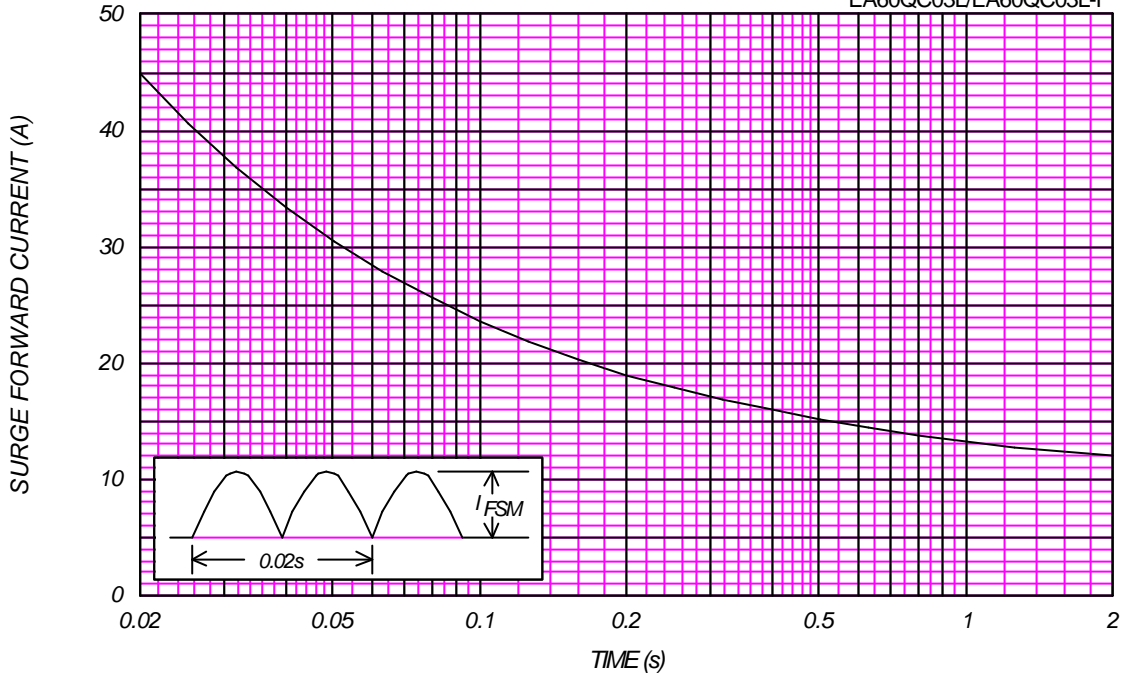

JUNCTION CAPACITANCE VS. REVERSE VOLTAGE

T_j=25° C,V_m=20mV_{RMS},f=100kHz,Typical Value

EA60QC03L/EA60QC03L-F (per Arm)

