

MC1439
MC1539

UNCOMPENSATED OPERATIONAL AMPLIFIER

... designed for use as a summing amplifier, integrator, or amplifier with operating characteristics as a function of the external feedback components.

- Low Input Offset Voltage — 3.0 mV max
- Low Input Offset Current — 60 nA max
- Large Power-Bandwidth — 20 Vp-p Output Swing at 20 kHz min
- Output Short-Circuit Protection
- Input Over-Voltage Protection
- Class AB Output for Excellent Linearity
- High Slew Rate — 34 V/ μ s typ

FIGURE 1 — HIGH SLEW-RATE INVERTER

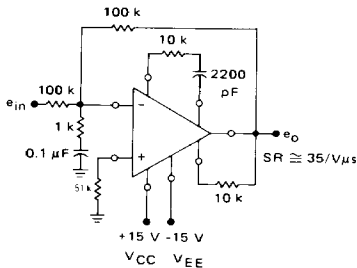

FIGURE 2 — OUTPUT NULLING CIRCUIT

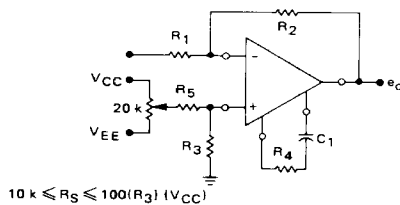
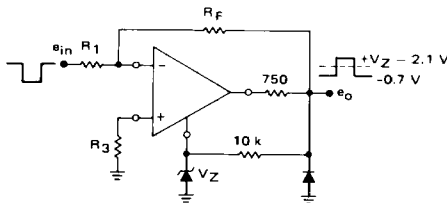

FIGURE 3 — OUTPUT LIMITING CIRCUIT



OPERATIONAL AMPLIFIER

SILICON MONOLITHIC
INTEGRATED CIRCUIT

G SUFFIX
METAL PACKAGE
CASE 601

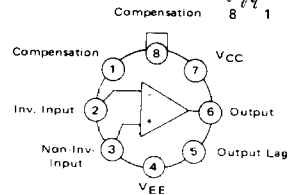
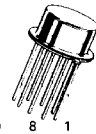

(Top View)

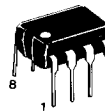

P1 SUFFIX
PLASTIC PACKAGE
CASE 626
(MC1439 Only)

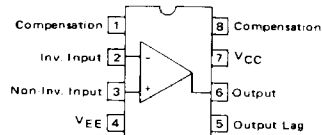

(Top View)

ORDERING INFORMATION

Device	Temperature Range	Package
MC1439G	0°C to +70°C	Metal Can
MC1439P1	0°C to +70°C	Plastic DIP
MC1539G	-55°C to +125°C	Metal Can

MC1439, MC1539

ELECTRICAL CHARACTERISTICS ($V_{CC} = +15$ Vdc, $V_{EE} = -15$ Vdc, $T_A = +25^\circ\text{C}$ unless otherwise noted.)

Characteristic	Symbol	MC1539			MC1439			Unit
		Min	Typ	Max	Min	Typ	Max	
Input Bias Current ($T_A = +25^\circ\text{C}$) ($T_A = T_{low}$ ①)	I_{IB}	—	0.20	0.50	—	0.20	1.0	μA
		—	0.23	0.70	—	0.23	1.5	
Input Offset Current ($T_A = T_{low}$) ($T_A = +25^\circ\text{C}$) ($T_A = T_{high}$ ①)	$ I_{IO} $	—	—	75	—	—	150	nA
		—	20	60	—	20	100	
		—	—	75	—	—	150	
Input Offset Voltage ($T_A = +25^\circ\text{C}$) ($T_A = T_{low}, T_{high}$)	$ V_{IO} $	—	1.0	3.0	—	2.0	7.5	mV
		—	—	4.0	—	—	—	
Average Temperature Coefficient of Input Offset Voltage ($T_A = T_{low}$ to T_{high}) ($R_S = 50 \Omega$) ($R_S \leq 10 \text{ k}\Omega$)	$ TCV_{IO} $	—	3.0	—	—	3.0	—	$\mu\text{V}/^\circ\text{C}$
		—	5.0	—	—	5.0	—	
Input Impedance ($f = 20 \text{ Hz}$)	z_{in}	150	300	—	100	300	—	$\text{k}\Omega$
Input Common-Mode Voltage Range	V_{ICR}	+11	+12	—	± 11	+12	—	V_{pk}
Equivalent Input Noise Voltage ($R_S = 10 \text{ k}\Omega$, Noise Bandwidth = 1.0 Hz, $f = 1.0 \text{ kHz}$)	e_n	—	30	—	—	30	—	$\text{nV}/(\text{Hz})^{1/2}$
Common-Mode Rejection Ratio ($f = 1.0 \text{ kHz}$)	CMRR	80	110	—	80	110	—	dB
Open-Loop Voltage Gain ($V_O = \pm 10 \text{ V}$, $R_L = 10 \text{ k}\Omega$, $R_S = \infty$) ($T_A = +25^\circ\text{C}$ to T_{high}) ($T_A = T_{low}$)	A_{VOL}	50,000	120,000	—	15,000	100,000	—	—
		25,000	100,000	—	15,000	100,000	—	
Power Bandwidth ($A_v = 1$, THD $\leq 5\%$, $V_O = 20 \text{ V}_{p-p}$) ($R_L = 2.0 \text{ k}\Omega$) ($R_L = 1.0 \text{ k}\Omega$, $R_S = 10 \text{ k}\Omega$)	PBW	—	—	—	10	50	—	kHz
		20	50	—	—	—	—	
Step Response { Gain = 1000, no overshoot, $R_1 = 1.0 \text{ k}\Omega$, $R_2 = 1.0 \text{ M}\Omega$, $R_3 = 1.0 \text{ k}\Omega$, $R_4 = 30 \text{ k}\Omega$, $R_5 = 10 \text{ k}\Omega$, $C_1 = 1000 \text{ pF}$ }	t_{THL}	—	130	—	—	130	—	ns
	t_{pd}	—	190	—	—	190	—	ns
	SR	—	6.0	—	—	6.0	—	$\text{V}/\mu\text{s}$
{ Gain = 1000, 15% overshoot, $R_1 = 1.0 \text{ k}\Omega$, $R_2 = 1.0 \text{ M}\Omega$, $R_3 = 1.0 \text{ k}\Omega$, $R_4 = 0$, $R_5 = 10 \text{ k}\Omega$, $C_1 = 10 \text{ pF}$ }	t_{THL}	—	80	—	—	80	—	ns
	t_{pd}	—	100	—	—	100	—	ns
	SR	—	14	—	—	14	—	$\text{V}/\mu\text{s}$
{ Gain = 100, no overshoot, $R_1 = 1.0 \text{ k}\Omega$, $R_2 = 100 \text{ k}\Omega$, $R_3 = 1.0 \text{ k}\Omega$, $R_4 = 10 \text{ k}\Omega$, $R_5 = 10 \text{ k}\Omega$, $C_1 = 2200 \text{ pF}$ }	t_{THL}	—	60	—	—	60	—	ns
	t_{pd}	—	100	—	—	100	—	ns
	SR	—	34	—	—	34	—	$\text{V}/\mu\text{s}$
{ Gain = 10, 15% overshoot, $R_1 = 1.0 \text{ k}\Omega$, $R_2 = 10 \text{ k}\Omega$, $R_3 = 1.0 \text{ k}\Omega$, $R_4 = 1.0 \text{ k}\Omega$, $R_5 = 10 \text{ k}\Omega$, $C_1 = 2200 \text{ pF}$ }	t_{THL}	—	120	—	—	120	—	ns
	t_{pd}	—	80	—	—	80	—	ns
	SR	—	6.25	—	—	6.25	—	$\text{V}/\mu\text{s}$
{ Gain = 1, 15% overshoot, $R_1 = 10 \text{ k}\Omega$, $R_2 = 10 \text{ k}\Omega$, $R_3 = 5.0 \text{ k}\Omega$, $R_4 = 390 \Omega$, $R_5 = 10 \text{ k}\Omega$, $C_1 = 2200 \text{ pF}$ }	t_{THL}	—	160	—	—	160	—	ns
	t_{pd}	—	80	—	—	80	—	ns
	SR	—	4.2	—	—	4.2	—	$\text{V}/\mu\text{s}$
Output Impedance ($f = 20 \text{ Hz}$)	z_o	—	4.0	—	—	4.0	—	$\text{k}\Omega$
Output Voltage Swing ($R_L = 2.0 \text{ k}\Omega$, $f = 1.0 \text{ kHz}$) ($R_L = 1.0 \text{ k}\Omega$, $f = 1.0 \text{ kHz}$)	V_O	—	—	—	+10	+13	—	V_{pk}
		± 10	+13	—	—	—	—	
Positive Supply Rejection Ratio (V_{EE} constant, $R_S = \infty$)	PSRR+	—	50	150	—	50	200	$\mu\text{V}/\text{V}$
Negative Supply Rejection Ratio (V_{CC} constant, $R_S = \infty$)	PSRR-	—	50	150	—	50	200	$\mu\text{V}/\text{V}$
Power Supply Current ($V_O = 0$)	I_{CC} I_{EE}	—	3.0	5.0	—	3.0	6.7	mA_{dc}
		—	3.0	5.0	—	3.0	6.7	

① $T_{low} = 0^\circ\text{C}$ for MC1439 $T_{high} = +70^\circ\text{C}$ for MC1439
 -55°C for MC1539 $+125^\circ\text{C}$ for MC1539

MC1439, MC1539

MAXIMUM RATINGS ($T_A = +25^\circ\text{C}$ unless otherwise noted.)

Rating	Symbol	Value	Unit
Power Supply Voltage	V_{CC} V_{EE}	+18 +18	Vdc
Differential Input Voltage Range	V_{IDR}	$\pm(V_{CC} + V_{EE})$	Vdc
Common-Mode Input Voltage Range	V_{ICR}	$+V_{CC}, - V_{EE} $	Vdc
Load Current	I_L	15	mA
Output Short-Circuit Duration	t_s	Continuous	
Power Dissipation (Package Limitation)	P_D		
Metal Package		680	mW
Derate above $T_A = +25^\circ\text{C}$		4.6	mW/ $^\circ\text{C}$
Plastic Dual In-Line Packages MC1439		625	mW
Derate above $T_A = +25^\circ\text{C}$		5.0	mW/ $^\circ\text{C}$
Operating Temperature Range	T_A	-55 to +125 0 to +70	$^\circ\text{C}$
Storage Temperature Range	T_{stg}	-65 to +150 -55 to +125	$^\circ\text{C}$

2

FIGURE 4 – EQUIVALENT CIRCUIT SCHEMATIC

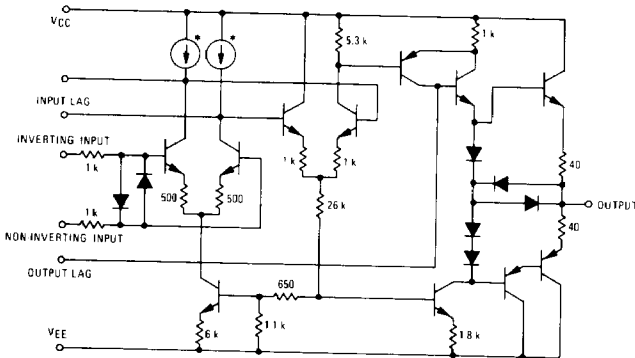
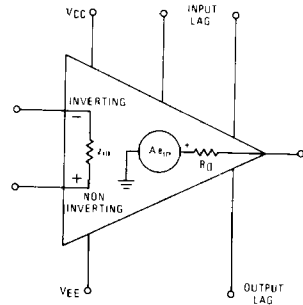

FIGURE 5 – EQUIVALENT CIRCUIT



TYPICAL OUTPUT CHARACTERISTICS

$V_{CC} = +15\text{ Vdc}$, $V_{EE} = -15\text{ Vdc}$, $T_A = +25^\circ\text{C}$

FIGURE NO.	CURVE NO.	VOLTAGE GAIN	TEST CONDITIONS (FIGURE 6)					
			R_1 (Ω)	R_2 (Ω)	R_3 (Ω)	R_4 (Ω)	R_5 (Ω)	C_1 (pF)
7, 10, 12	1	A_{vol}	0	∞	0	∞	∞	0
	2	1	10k	10k	5.0k	390	10k	2200
	3	10	1.0k	1.0k	5.0k	1.0k	10k	2200
	4	100	1.0k	100k	1.0k	1.0k	10k	2200
	5	1000	1.0k	1.0M	1.0k	30k	10k	1000
	6	1000	1.0k	1.0M	1.0k	0	10k	10
8	1	A_{vol}	0	∞	0	∞	0	0
	2	1	10k	10k	5.0k	390	10k	2200
	3	10	1.0k	1.0k	5.0k	1.0k	10k	2200
	4	100	1.0k	100k	1.0k	1.0k	10k	2200
	5	1000	1.0k	1.0M	1.0k	30k	10k	1000
	6	1000	1.0k	1.0M	1.0k	0	10k	10
13	ALL	1	10k	10k	5.0k	390	10k	2200
14	ALL	10	1.0k	1.0k	5.0k	1.0k	10k	2200
15	ALL	100	1.0k	100k	1.0k	1.0k	10k	2200
16	ALL	1000	1.0k	1.0M	1.0k	30k	10k	2200

FIGURE 6 – TEST CIRCUIT

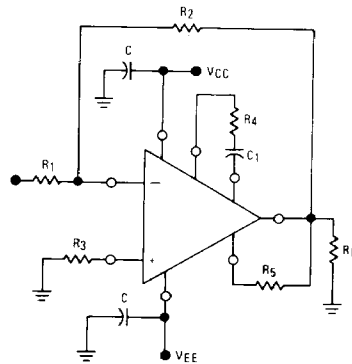

MC1439, MC1539

TYPICAL CHARACTERISTICS (continued)

($V_{CC} = +15 \text{ Vdc}$, $V_{EE} = -15 \text{ Vdc}$, $T_A = +25^\circ\text{C}$, unless otherwise noted.)

FIGURE 7 – LARGE-SIGNAL SWING versus FREQUENCY

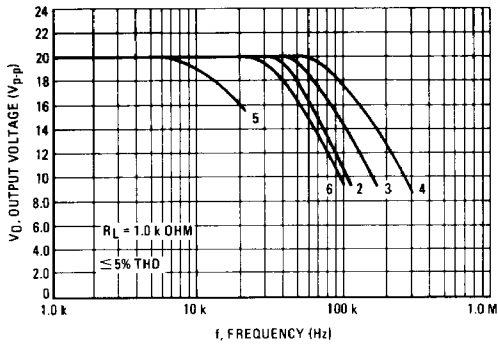

FIGURE 8 – OPEN-LOOP VOLTAGE GAIN versus FREQUENCY

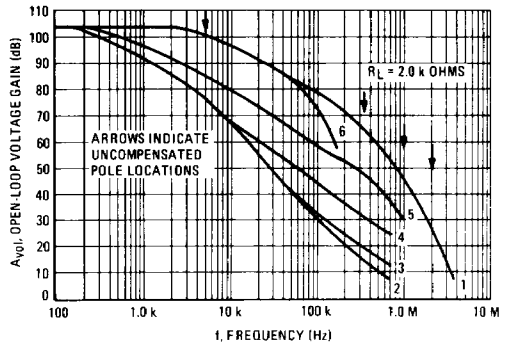

FIGURE 9 – OUTPUT VOLTAGE SWING versus LOAD RESISTANCE

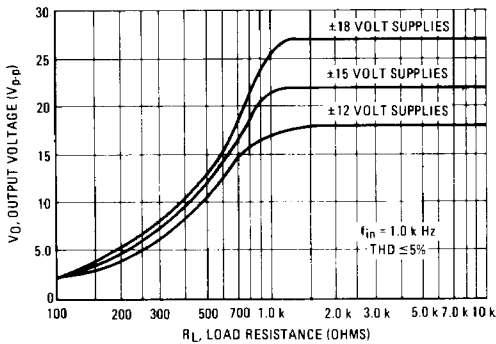

FIGURE 10 – OPEN-LOOP PHASE-SHIFT versus FREQUENCY

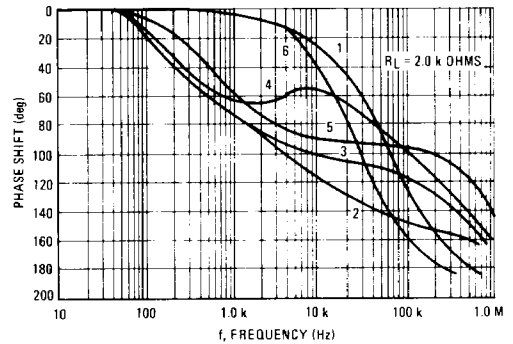

FIGURE 11 – OUTPUT VOLTAGE SWING (to clipping) versus SUPPLY

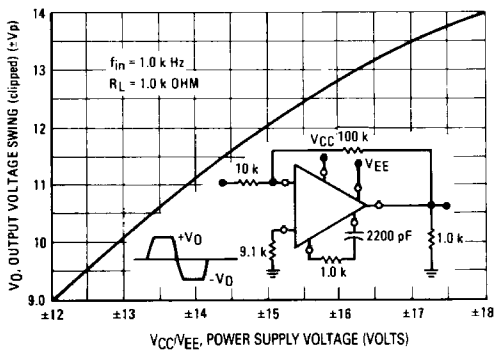
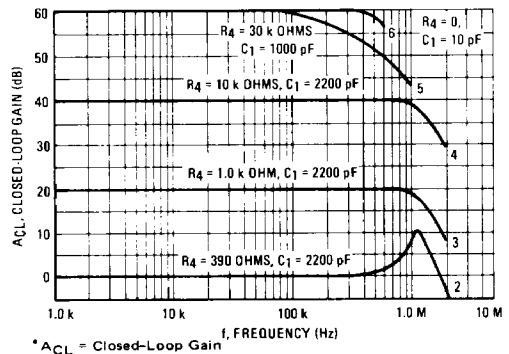

FIGURE 12 – CLOSED-LOOP GAIN versus FREQUENCY



MC1439, MC1539

TYPICAL CHARACTERISTICS (continued)

($V_{CC} = +15$ Vdc, $V_{EE} = -15$ Vdc, $T_A = +25^\circ\text{C}$, unless otherwise noted.)

FIGURE 13 — $A_{CL} = 1$ RESPONSE versus TEMPERATURE

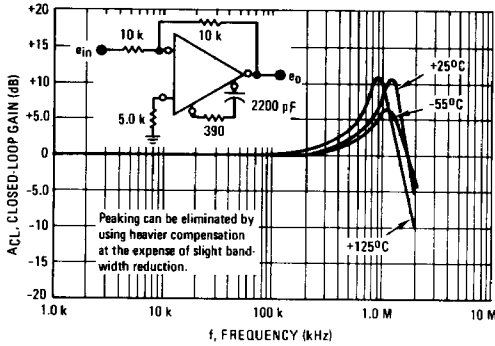

FIGURE 14 — $A_{CL} = 10$ RESPONSE versus TEMPERATURE

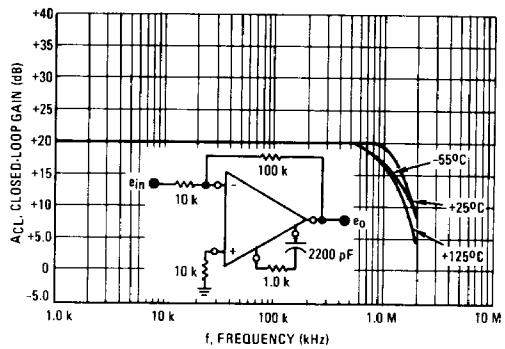

FIGURE 15 — $A_{CL} = 100$ RESPONSE versus TEMPERATURE

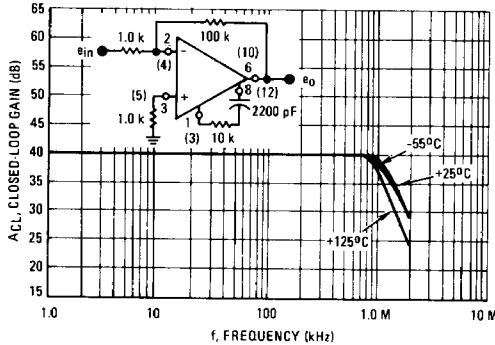

FIGURE 16 — $A_{CL} = 1000$ RESPONSE versus TEMPERATURE

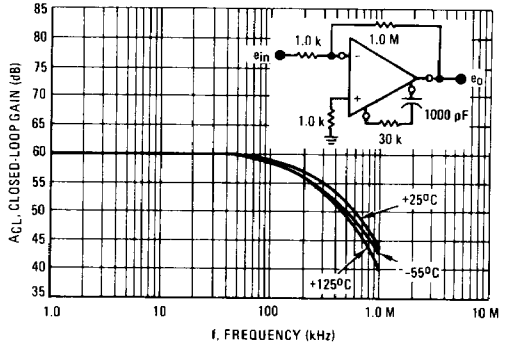
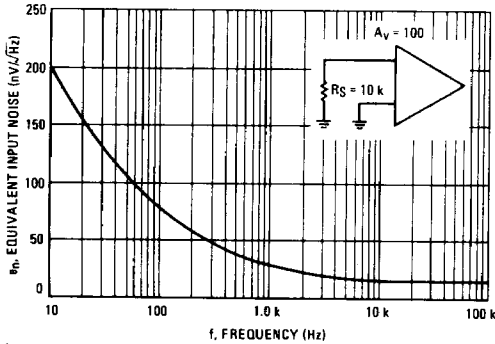
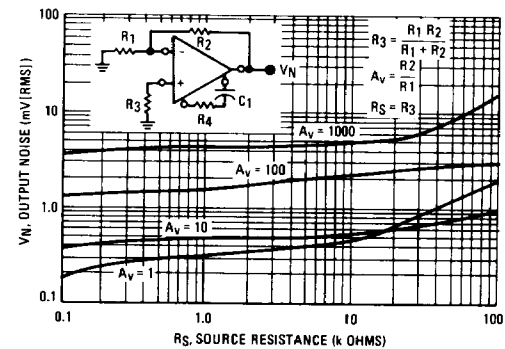

FIGURE 17 — SPECTRAL NOISE DENSITY



* A_{CL} = Closed-Loop Gain

FIGURE 18 — OUTPUT NOISE versus SOURCE RESISTANCE



MC1439, MC1539

TYPICAL CHARACTERISTICS (continued)

($V_{CC} = +15$ Vdc, $V_{EE} = -15$ Vdc, $T_A = +25^\circ\text{C}$, unless otherwise noted.)

FIGURE 19 – POWER DISSIPATION versus TEMPERATURE

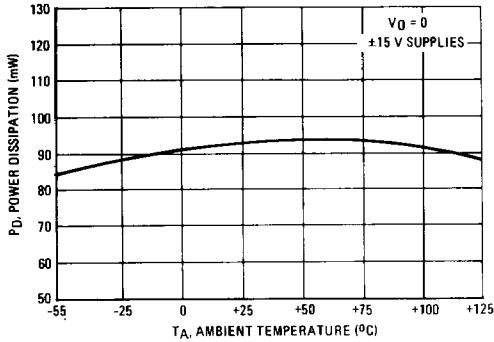

FIGURE 20 – POWER DISSIPATION versus POWER SUPPLY VOLTAGE

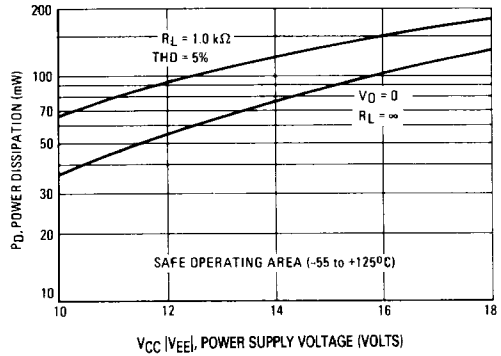

FIGURE 21 – POWER BANDWIDTH (LARGE-SIGNAL SWING versus FREQUENCY)

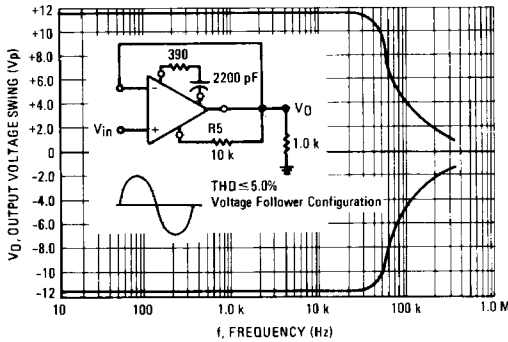

FIGURE 22 – COMMON-MODE INPUT VOLTAGE versus SUPPLY VOLTAGE

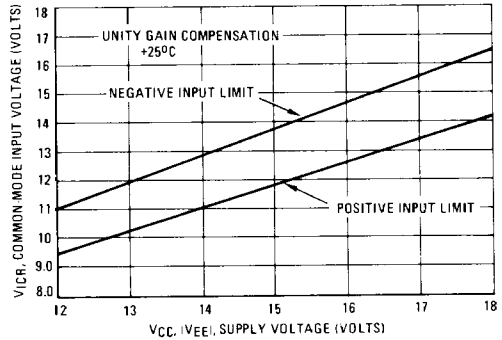

FIGURE 23 – COMMON-MODE REJECTION RATIO versus FREQUENCY

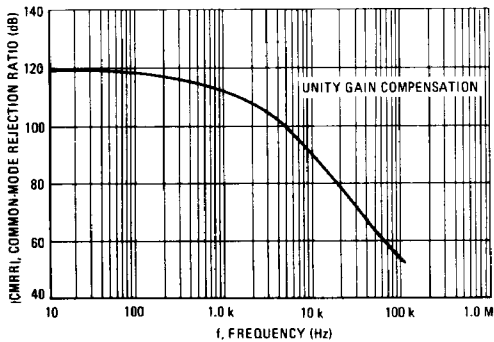
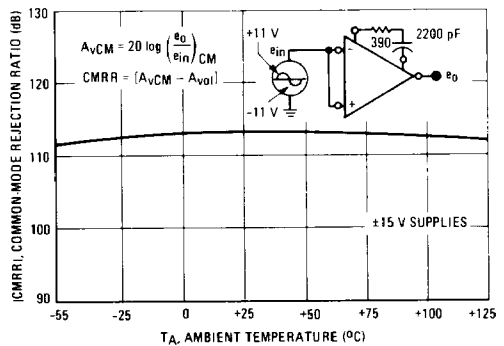
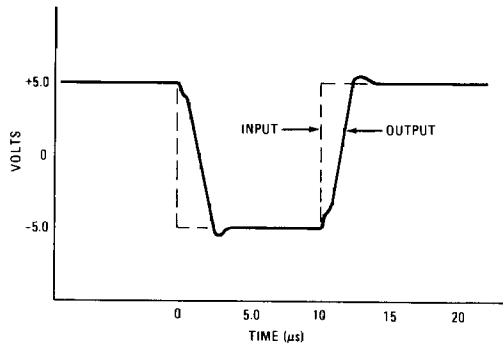

FIGURE 24 – COMMON-MODE REJECTION RATIO versus TEMPERATURE



MC1439, MC1539

FIGURE 25 – VOLTAGE-FOLLOWER PULSE RESPONSE



TYPICAL APPLICATIONS

FIGURE 26 – VOLTAGE FOLLOWER

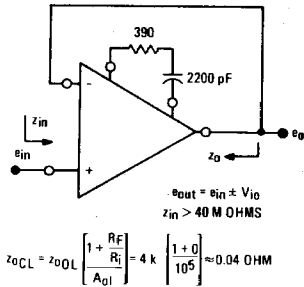

FIGURE 27 – DIFFERENTIAL AMPLIFIER

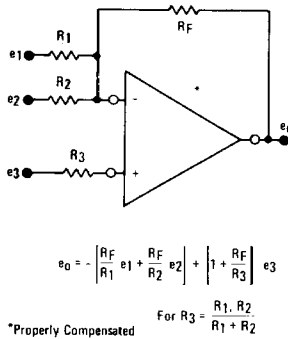

FIGURE 28 – SUMMING AMPLIFIER

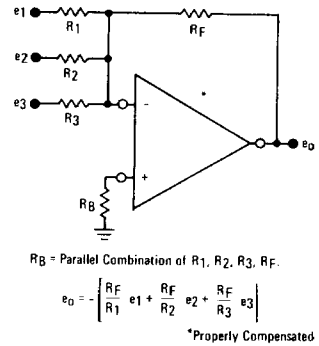
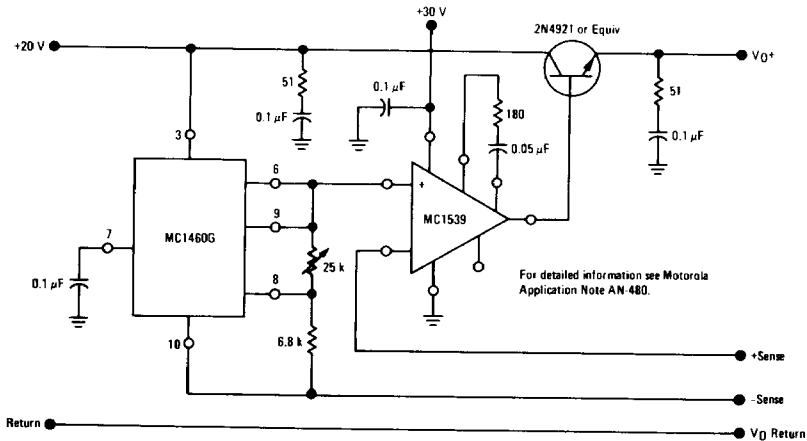

FIGURE 29 – +15 VOLT REGULATOR



TYPICAL APPLICATIONS (continued)

FIGURE 30 – LOAD REGULATION FOR
CIRCUIT OF FIGURE 29

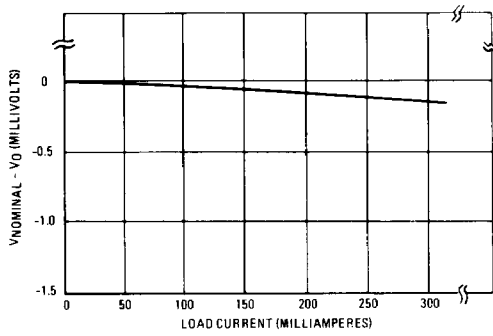

FIGURE 31 – REGULATOR OUTPUT VOLTAGE
(under pulsed load condition)

