

International **IOR** Rectifier

QUIETIR Series 30EPF.. 30CPF.. HV

FAST SOFT RECOVERY RECTIFIER DIODE

Description/Features

The 30EPF.. & 30CPF.. soft recovery *QUIETIR* rectifier series has been optimized for combined short reverse recovery time and low forward voltage drop.

The glass passivation ensures stable reliable operation in the most severe temperature and power cycling conditions.

Typical applications are:

- Output rectification and freewheeling in inverters, choppers and converters
- and input rectifications where severe restrictions on conducted EMI should be met.
- 30CPF series is a drop in replacement for 25CPF Series (parallel connection only)

| | | |
|---|-----------|---------------|
|  | V_F | < 1.41V @ 30A |
| | t_{rr} | = 95 ns |
| | V_{RRM} | 1000 to 1200V |

Major Ratings and Characteristics

| Characteristics | 30EPF.. 30CPF.. | Units |
|---------------------------------------|--------------------|------------------|
| $I_{F(AV)}$ Sinusoidal waveform | 30 | A |
| V_{RRM} | 1000 to 1200 | V |
| I_{FSM} | 350 | A |
| V_F @ 30A, $T_J = 25^\circ\text{C}$ | 1.41 | V |
| t_{rr} @ 1A, 100A/ μs | 95 | ns |
| T_J | -40 to 150 | $^\circ\text{C}$ |

Package Outline

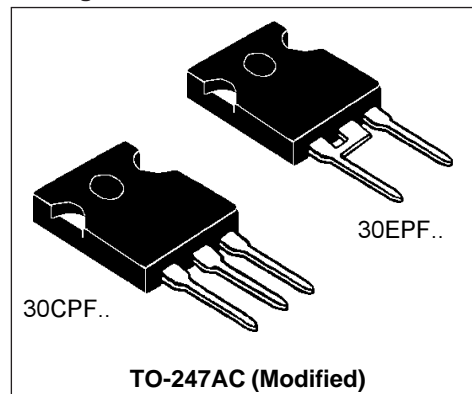

30EPF.. 30CPF.. HV QUIETIR Series

Preliminary Data Sheet I2138 09/97

International
IOR Rectifier

Voltage Ratings

| Part Number | V_{RRM} , maximum peak reverse voltage V | V_{RSM} , maximum non repetitive peak reverse voltage V | I_{RRM} 150°C mA |
|------------------|---|--|--------------------------|
| 30EPF10, 30CPF10 | 1000 | 1100 | 6 |
| 30EPF12, 30CPF12 | 1200 | 1300 | |

Absolute Maximum Ratings

| Parameters | 30.PF.. | Units | Conditions |
|--|---------|---------------|---|
| $I_{F(AV)}$ Max. Average Forward Current | 30 | A | @ $T_C = 95^\circ\text{C}$, 180° conduction half sine wave |
| I_{FSM} Max. Peak One Cycle Non-Repetitive Surge Current | 300 | A | 10ms Sine pulse, rated V_{RRM} applied |
| | 350 | | 10ms Sine pulse, no voltage reapplied |
| I^2t Max. I^2t for fusing | 450 | A^2s | 10ms Sine pulse, rated V_{RRM} applied |
| | 636 | | 10ms Sine pulse, no voltage reapplied |
| $I^2\sqrt{t}$ Max. $I^2\sqrt{t}$ for fusing | 6360 | $A^2\sqrt{s}$ | $t = 0.1$ to 10ms, no voltage reapplied |

Electrical Specifications

| Parameters | 30.PF.. | Units | Conditions |
|---------------------------------------|---------|-----------|---------------------------------|
| V_{FM} Max. Forward Voltage Drop | 1.41 | V | @ 30A, $T_J = 25^\circ\text{C}$ |
| r_t Forward slope resistance | 10.09 | $m\Omega$ | $T_J = 150^\circ\text{C}$ |
| $V_{F(TO)}$ Threshold voltage | 0.992 | V | |
| I_{RM} Max. Reverse Leakage Current | 0.1 | mA | $T_J = 25^\circ\text{C}$ |
| | 6 | | $T_J = 150^\circ\text{C}$ |

$V_R = \text{rated } V_{RRM}$

Typical Recovery Characteristics

| Parameters | 30.PF.. | Units | Conditions |
|-----------------------------------|---------|---------------|--|
| t_{rr} Reverse Recovery Time | 450 | ns | $I_F @ 30\text{Apk}$ @ 25A/ μs @ 25°C |
| I_{rr} Reverse Recovery Current | 6.1 | A | |
| Q_{rr} Reverse Recovery Charge | 2.16 | μC | |
| S Snap Factor t_b/t_a | 0.6 | typical | |

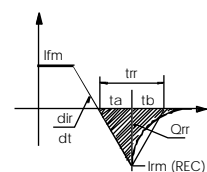

Thermal-Mechanical Specifications

| Parameters | 30.PF.. | Units | Conditions |
|---|-------------|-------------------|--------------------------------------|
| T_J Max. Junction Temperature Range | -40 to 150 | °C | |
| T_{stg} Max. Storage Temperature Range | -40 to 150 | °C | |
| R_{thJC} Max. Thermal Resistance Junction to Case | 0.8 | °C/W | DC operation |
| R_{thJA} Max. Thermal Resistance Junction to Ambient | 40 | °C/W | |
| R_{thCS} Typical Thermal Resistance, Case to Heatsink | 0.2 | °C/W | Mounting surface, smooth and greased |
| wt Approximate Weight | 6(0.21) | g(oz.) | |
| T Mounting Torque | Min. 6(5) | Kg-cm (lbf-in) | |
| | Max. 12(10) | | |
| Case Style | TO-247AC | | JEDEC(Modified) |

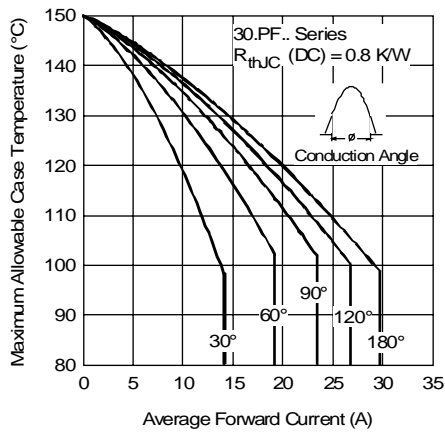

Fig. 1 - Current Rating Characteristics

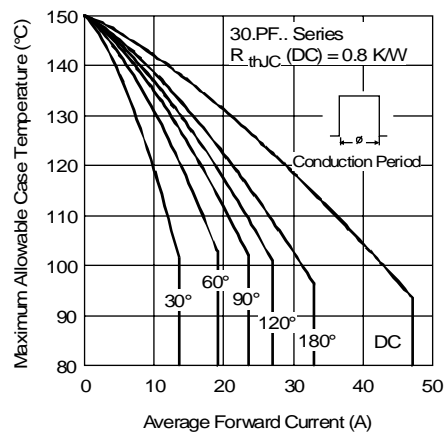

Fig. 2 - Current Rating Characteristics

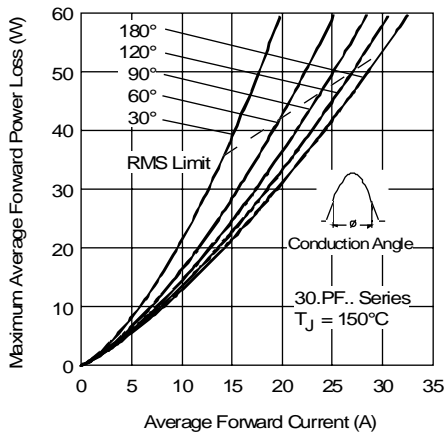

Fig. 3 - Forward Power Loss Characteristics

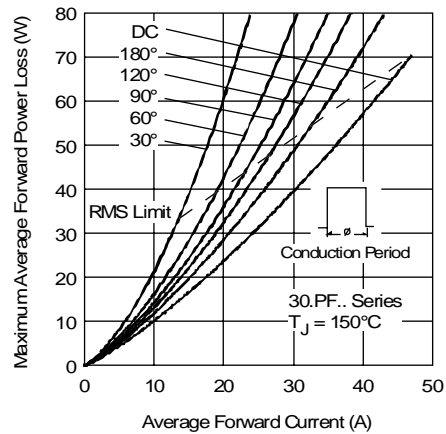

Fig. 4 - Forward Power Loss Characteristics

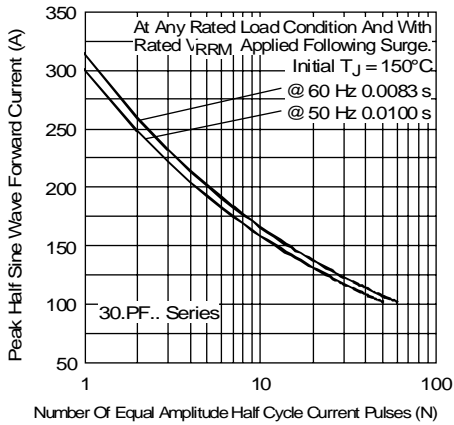

Fig. 5 - Maximum Non-Repetitive Surge Current

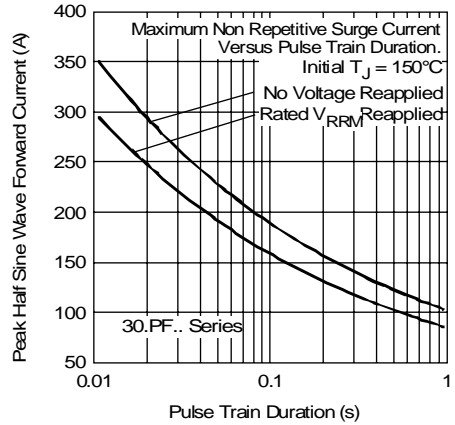

Fig. 6 - Maximum Non-Repetitive Surge Current

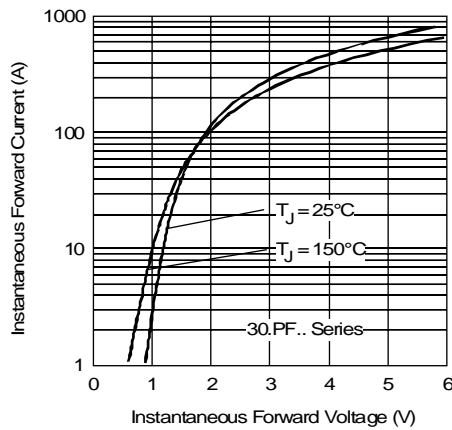

Fig. 7 - Forward Voltage Drop Characteristics

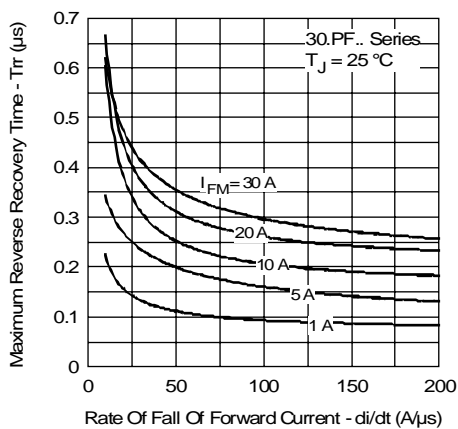

Fig. 8 - Recovery Time Characteristics, $T_J = 25^\circ\text{C}$

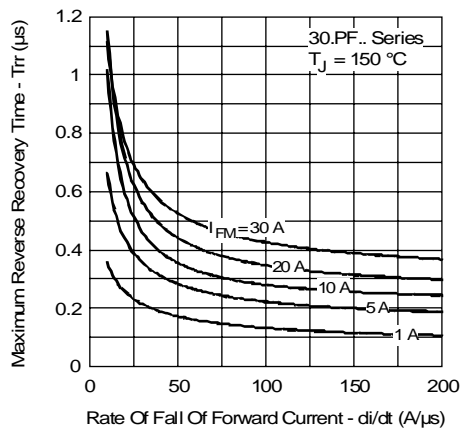

Fig. 9 - Recovery Time Characteristics, $T_J = 150^\circ\text{C}$

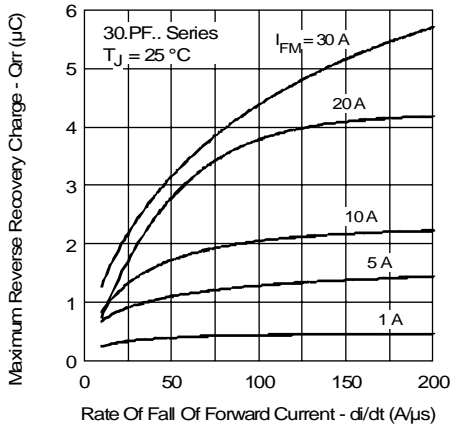

Fig. 10 - Recovery Charge Characteristics, $T_J = 25^\circ\text{C}$

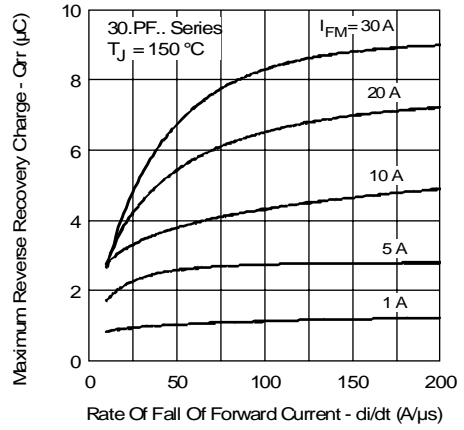

Fig. 11 - Recovery Charge Characteristics, $T_J = 150^\circ\text{C}$

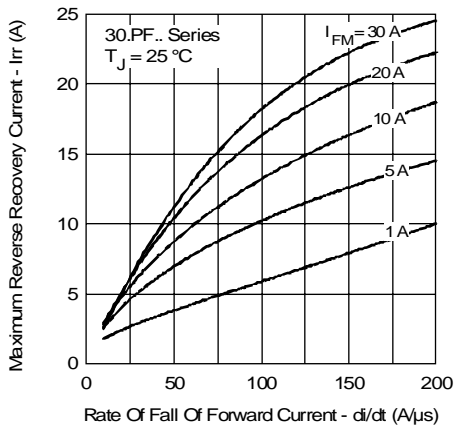

Fig. 12 - Recovery Current Characteristics, $T_J = 25^\circ\text{C}$

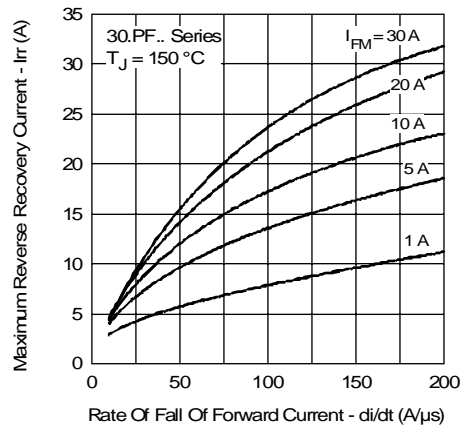

Fig. 13 - Recovery Current Characteristics, $T_J = 150^\circ\text{C}$

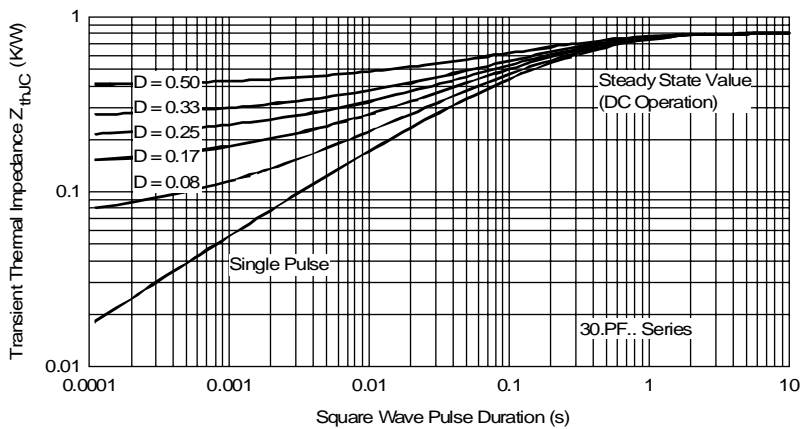
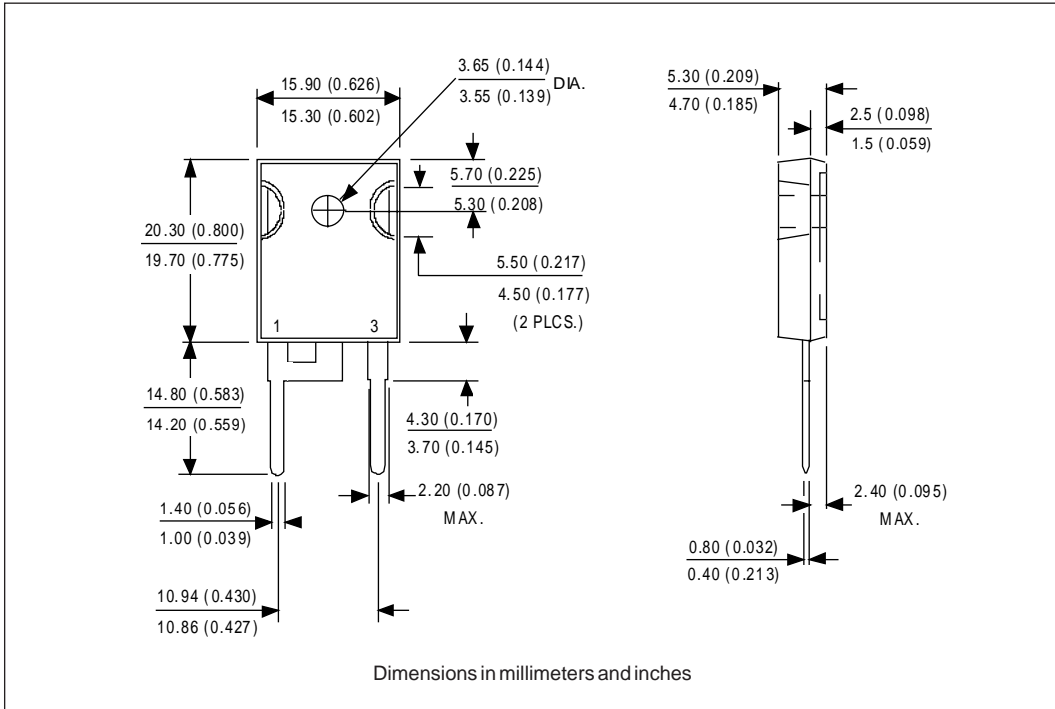
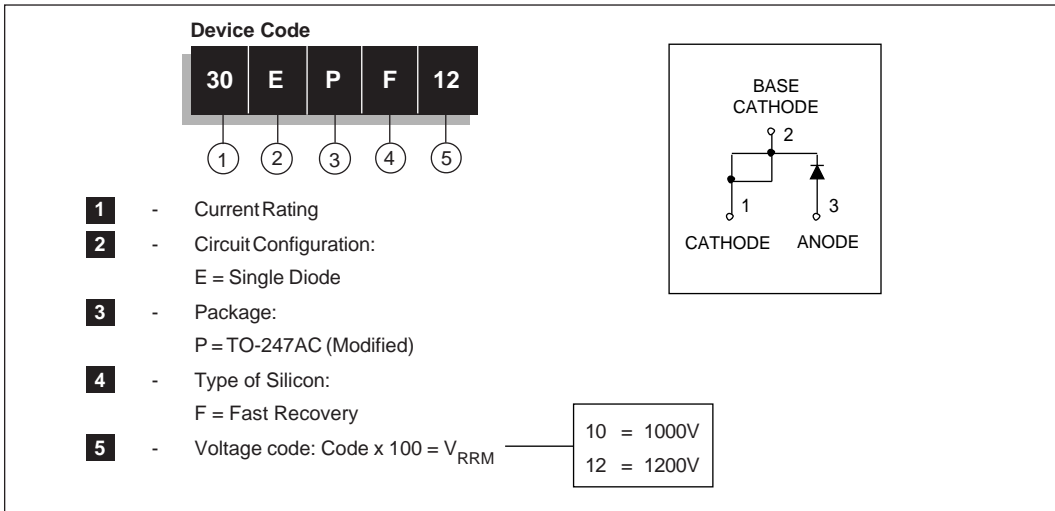

Fig. 14 - Thermal Impedance Z_{thJC} Characteristics

Outline Table



Ordering Information Table



Outline Table

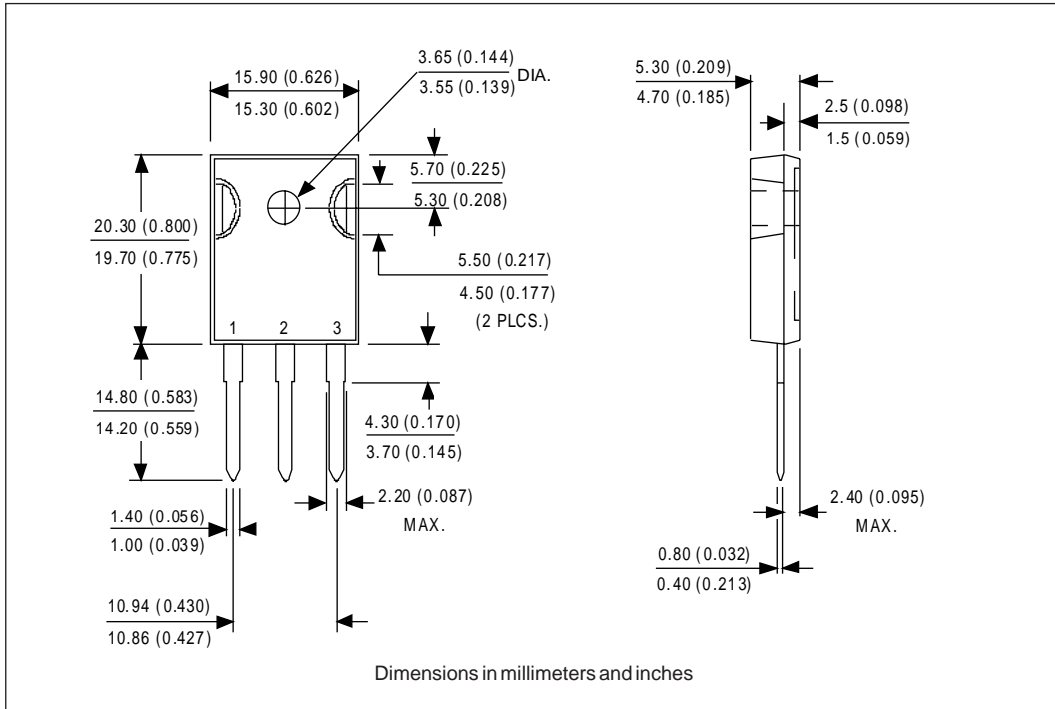

Ordering Information Table

