

FS2KMJ-3

HIGH-SPEED SWITCHING USE

FS2KMJ-3



- 4V DRIVE
- V_{DSS} 150V
- $r_{DS(ON)}$ (MAX) 0.75Ω
- I_D 2A
- Integrated Fast Recovery Diode (TYP.) 65ns
- V_{iso} 2000V

OUTLINE DRAWING

Dimensions in mm

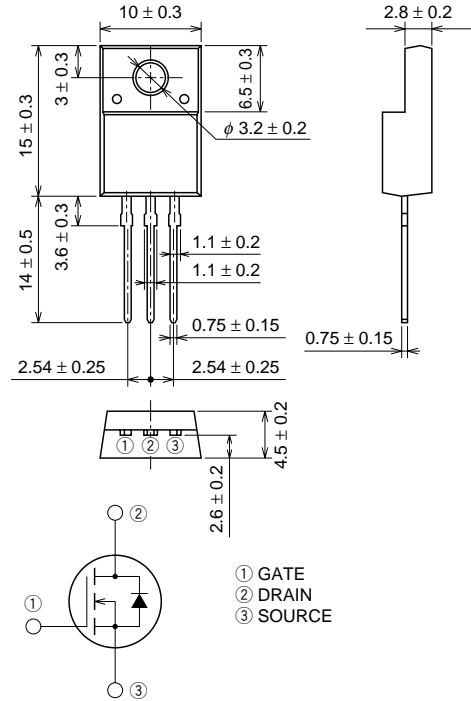

TO-220FN

APPLICATION

Motor control, Lamp control, Solenoid control
DC-DC converter, etc.

MAXIMUM RATINGS (Tc = 25°C)

Symbol	Parameter	Conditions	Ratings	Unit
V_{DSS}	Drain-source voltage	$V_{GS} = 0V$	150	V
V_{GSS}	Gate-source voltage	$V_{DS} = 0V$	± 20	V
I_D	Drain current		2	A
I_{DM}	Drain current (Pulsed)		8	A
I_{DA}	Avalanche drain current (Pulsed)	$L = 100\mu H$	2	A
I_S	Source current		2	A
I_{SM}	Source current (Pulsed)		8	A
P_D	Maximum power dissipation		15	W
T_{ch}	Channel temperature		-55 ~ +150	°C
T_{stg}	Storage temperature		-55 ~ +150	°C
V_{iso}	Isolation voltage	AC for 1minute, Terminal to case	2000	V
—	Weight	Typical value	2.0	g

ELECTRICAL CHARACTERISTICS (Tch = 25°C)

Symbol	Parameter	Test conditions	Limits			Unit
			Min.	Typ.	Max.	
V(BR)DSS	Drain-source breakdown voltage	Id = 1mA, Vgs = 0V	150	—	—	V
IgSS	Gate-source leakage current	Vgs = ±20V, Vds = 0V	—	—	±0.1	μA
IbSS	Drain-source leakage current	Vds = 150V, Vgs = 0V	—	—	0.1	mA
VGS(th)	Gate-source threshold voltage	Id = 1mA, Vds = 10V	1.0	1.5	2.0	V
rDS(ON)	Drain-source on-state resistance	Id = 1A, Vgs = 10V	—	0.58	0.75	Ω
rDS(ON)	Drain-source on-state resistance	Id = 1A, Vgs = 4V	—	0.61	0.81	Ω
VDS(ON)	Drain-source on-state voltage	Id = 1A, Vgs = 10V	—	0.58	0.75	V
yfs	Forward transfer admittance	Id = 1A, Vds = 5V	—	4.5	—	S
Ciss	Input capacitance	Vds = 10V, Vgs = 0V, f = 1MHz	—	360	—	pF
Coss	Output capacitance		—	62	—	pF
Crss	Reverse transfer capacitance		—	16	—	pF
td(on)	Turn-on delay time	VDD = 80V, Id = 1A, Vgs = 10V, RGEN = RGS = 50Ω	—	11	—	ns
tr	Rise time		—	9	—	ns
td(off)	Turn-off delay time		—	35	—	ns
tf	Fall time		—	13	—	ns
VSD	Source-drain voltage	Is = 1A, Vgs = 0V	—	1.0	1.5	V
Rth(ch-c)	Thermal resistance	Channel to case	—	—	8.33	°C/W
trr	Reverse recovery time	Is = 2A, dis/dt = -100A/μs	—	65	—	ns

PERFORMANCE CURVES

POWER DISSIPATION DERATING CURVE

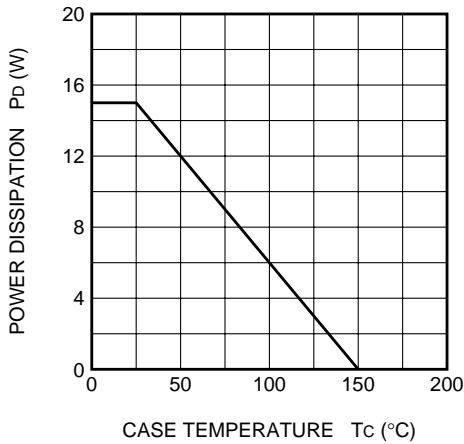

MAXIMUM SAFE OPERATING AREA

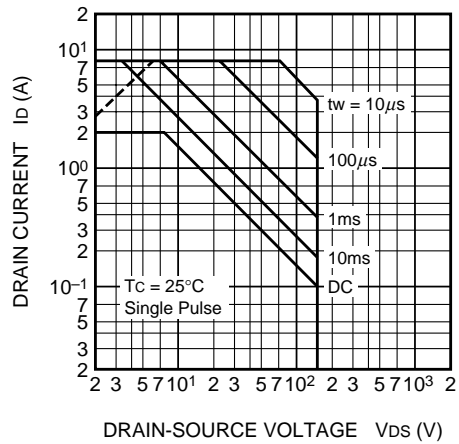

OUTPUT CHARACTERISTICS (TYPICAL)

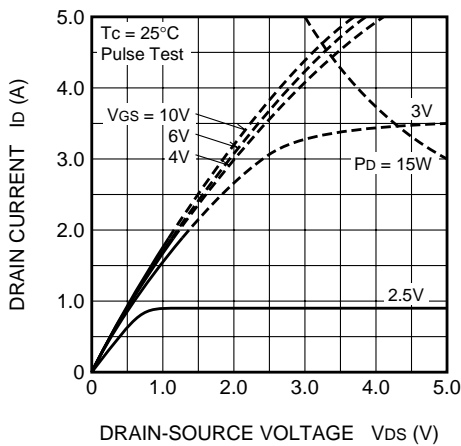

OUTPUT CHARACTERISTICS (TYPICAL)

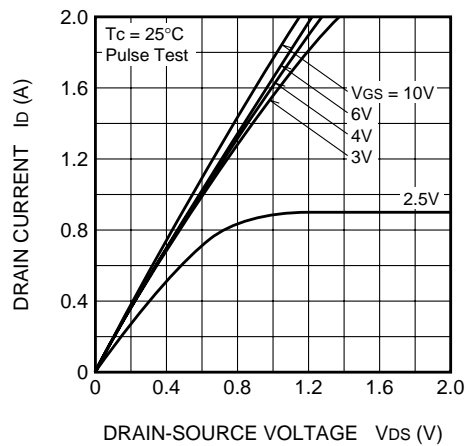

ON-STATE VOLTAGE VS. GATE-SOURCE VOLTAGE (TYPICAL)

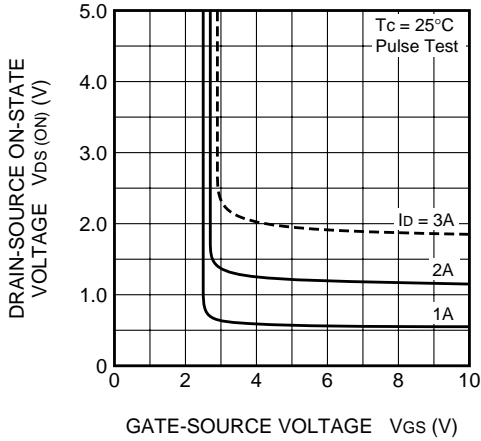

ON-STATE RESISTANCE VS. DRAIN CURRENT (TYPICAL)

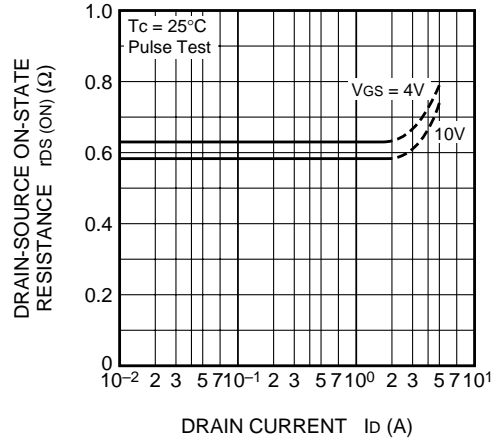

TRANSFER CHARACTERISTICS (TYPICAL)

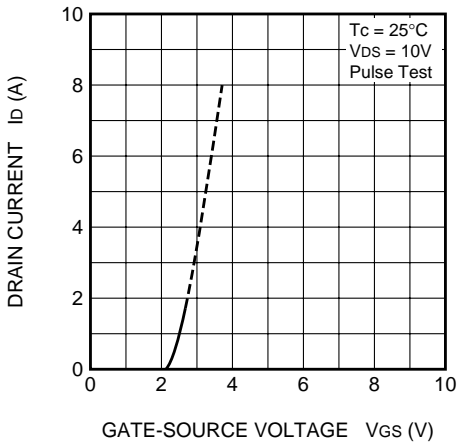

FORWARD TRANSFER ADMITTANCE VS. DRAIN CURRENT (TYPICAL)

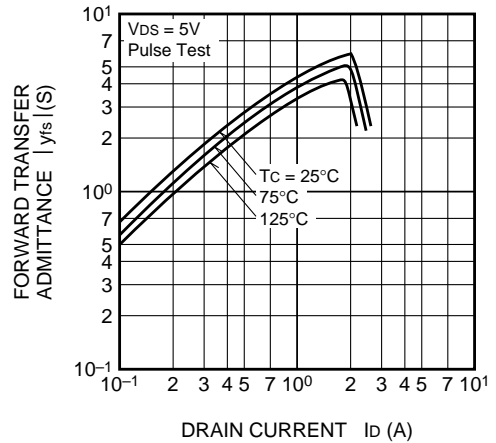

CAPACITANCE VS. DRAIN-SOURCE VOLTAGE (TYPICAL)

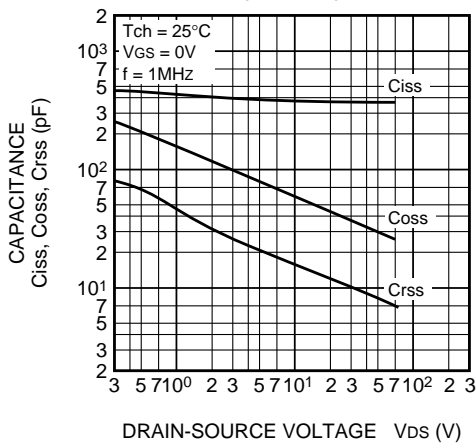

SWITCHING CHARACTERISTICS (TYPICAL)

