

# MN3009

## 256-STAGE LOW NOISE BBD

### General description

The MN3009 is a 256-stage BBD having a wide dynamic range and low distortion characteristics. The MN3009 provides a signal delay of up to 12.8msec and is particularly suitable as a device for generation of vibrato and/or chorus effects in electronic musical instruments.

### Features

- Variable delay time of audio signals: 0.64 ~ 12.8ms.
- Clock component cancellation capability.
- No insertion loss:  $L_i = 0\text{dB typ.}$
- Wide dynamic range:  $S/N = 88\text{dB typ.}$
- Wide frequency response:  $f_i \leq 14\text{KHz.}$
- Low distortion:  $\text{THD} = 0.3\% \text{ typ. (} V_i = 0.78\text{Vrms).}$
- Clock frequency range: 10 ~ 200KHz.
- P channel silicon gate process.
- 8-Lead Dual-In-Line Plastic Package.

### Applications

- Vibrato and/or chorus effect in electronic musical instrument.
- Reverberation effect in electronic musical instruments.
- Variable or fixed delay of analog signals.

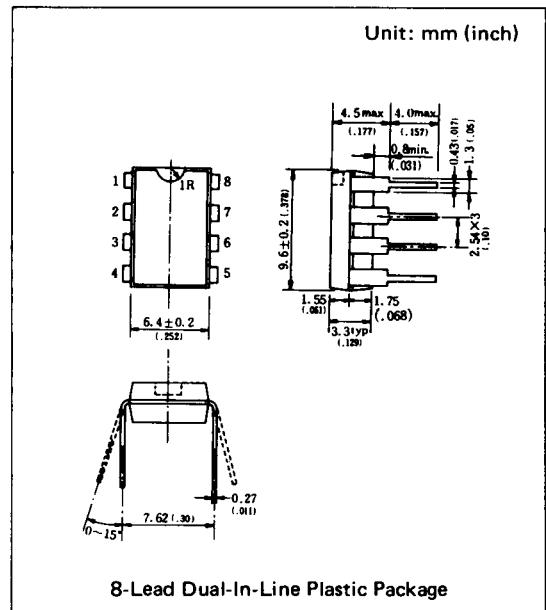

### Block Diagram

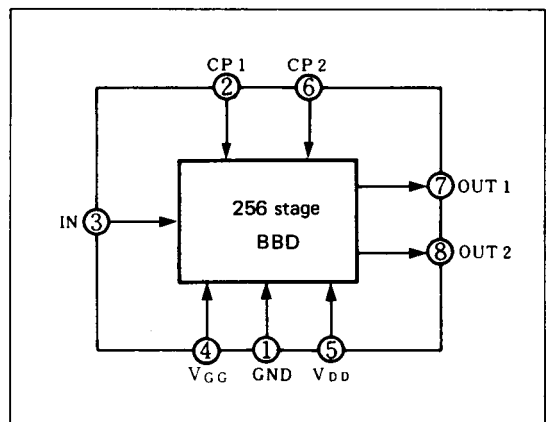

### Quick Reference Data

Item	Symbol	Value	Unit
Supply Voltage	$V_{DD}, V_{GG}$	$-15, V_{DD} + 1$	V
Signal Delay Time	$t_D$	0.64~12.8	ms
Total Harmonic Distortion	THD	0.3	%
Signal to Noise Ratio	S/N	88	dB

■ Absolute Maximum Ratings (Ta = 25°C)

Item	Symbol	Ratings	Unit
Terminal Voltage	V <sub>DD</sub> , V <sub>GG</sub> , V <sub>CP</sub> , V <sub>I</sub>	-18~+0.3	V
Output Voltage	V <sub>O</sub>	-18~+0.3	V
Operating Temperature	T <sub>opr</sub>	-20~+60	°C
Storage	T <sub>stg</sub>	-55~+125	°C

■ Operating Conditions (Ta = 25°C)

Item	Symbol	Min.	Typ.	Max.	Unit
Drain Supply Voltage	V <sub>DD</sub>	-14	-15	-16	V
Gate Supply Voltage	V <sub>GG</sub>		V <sub>DD</sub> +1		V
Clock Voltage "H" Level	V <sub>CPH</sub>	0		-1	V
Clock Voltage "L" Level	V <sub>CPL</sub>		V <sub>DD</sub>		V
Clock Input Capacitance	C <sub>CP</sub>			200	pF
Clock Frequency	f <sub>CP</sub>	10		200	kHz
Clock Pulse Width *1	t <sub>cpw</sub>			0.5T *2	
Clock Rise Time *1	t <sub>cpr</sub>			500	ns
Clock Fall Time *1	t <sub>cpf</sub>			500	ns
Clock Cross Point *1	V <sub>x</sub>	0		-3	V
Input DC Bias	V <sub>Bias</sub>	-5		-10	V

■ Electrical Characteristics (Ta = 25°C, V<sub>DD</sub> = V<sub>CPL</sub> = -15V, V<sub>CPH</sub> = 0V, V<sub>GG</sub> = -14V, R<sub>L</sub> = 100kΩ)

Item	Symbol	Condition	Min.	Typ.	Max.	Unit
Signal Delay Time	t <sub>D</sub>		0.64		12.8	ms
Input Signal Frequency	f <sub>i</sub>	f <sub>CP</sub> = 40kHz, V <sub>i</sub> = 1.5Vrms 3dB down (0dB at f <sub>i</sub> = 1kHz)	12			kHz
Input Signal Swing	V <sub>i</sub>	f <sub>CP</sub> = 40kHz, f <sub>i</sub> = 1 kHz, THD = 2.5%	1.5			Vrms
Insertion Loss	L <sub>i</sub>	f <sub>CP</sub> = 40kHz, f <sub>i</sub> = 1 kHz, V <sub>i</sub> = 1.7Vrms	-4	0	4	dB
Total Harmonic Distortion	THD	f <sub>CP</sub> = 40kHz, f <sub>i</sub> = 1 kHz, V <sub>i</sub> = 0.78Vrms		0.3	2.5	%
Noise	V <sub>NO</sub>	f <sub>CP</sub> = 100kHz Weighted by "A" curve			0.2	mVrms
Signal to Noise Ratio	S/N	Maximum output voltage to noise voltage		88		dB

\*1 Clock Pulse Waveforms

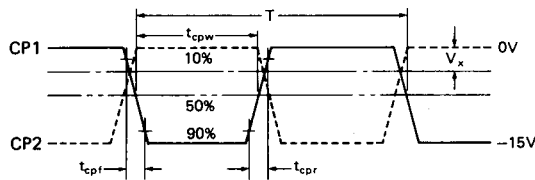

\*2 T = 1/f<sub>CP</sub> (Clock period)

■ Terminal Assignments

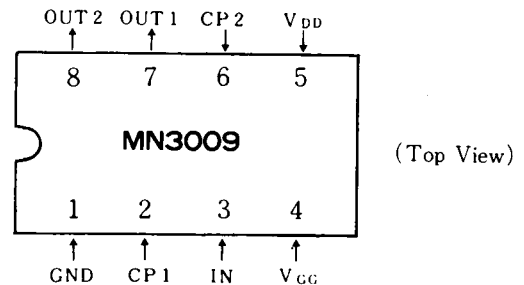

■ Circuit Diagram

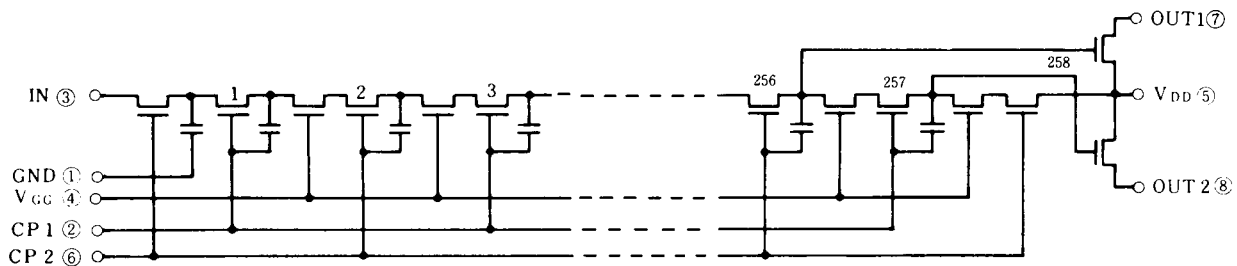

■ Typical Electrical Characteristic Curves

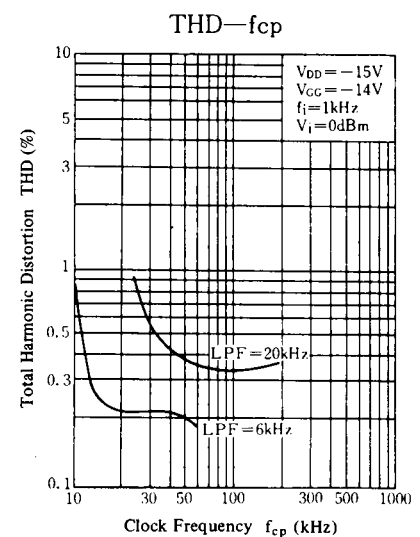
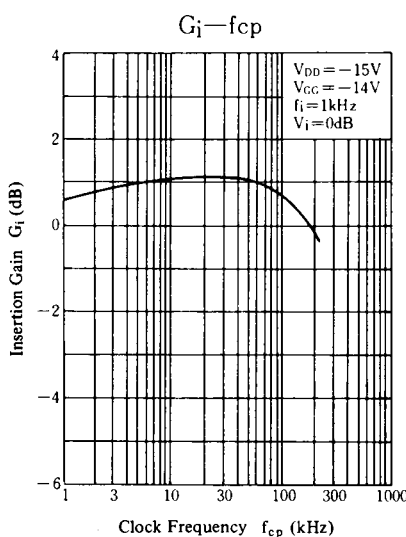
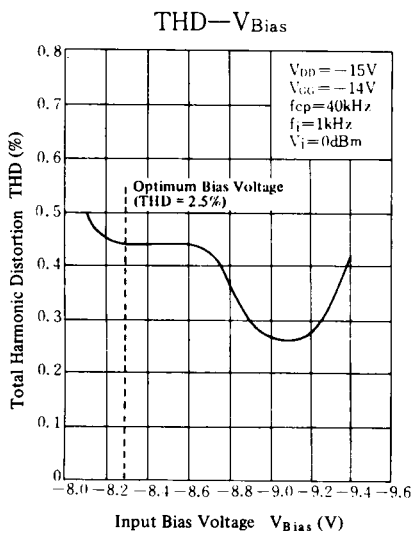
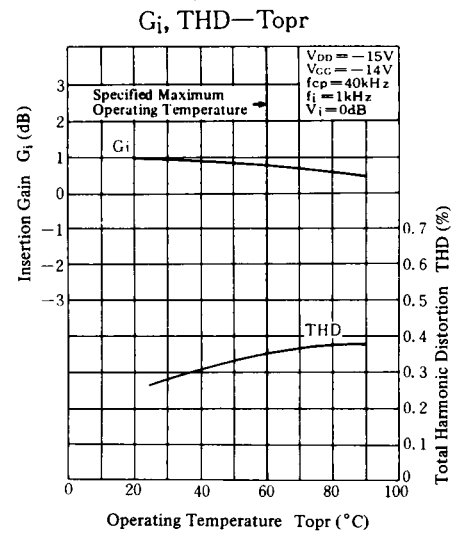
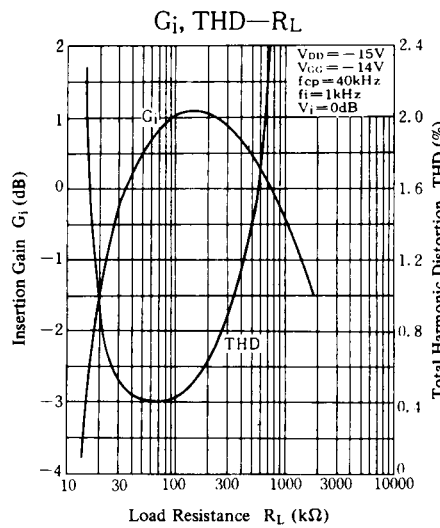
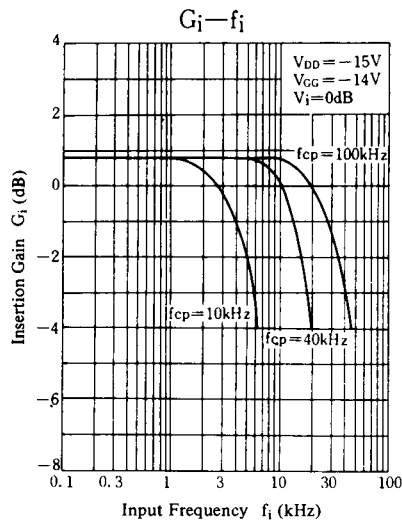
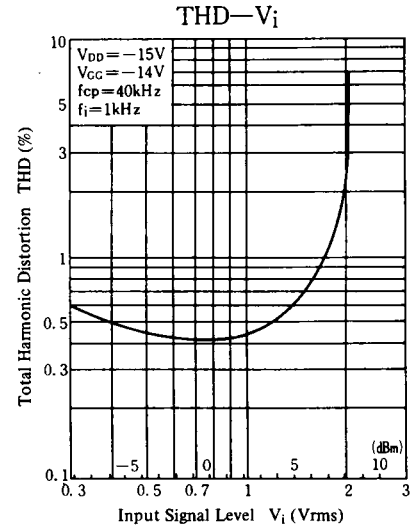
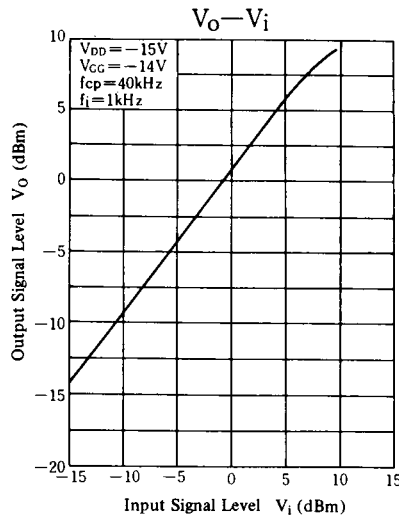
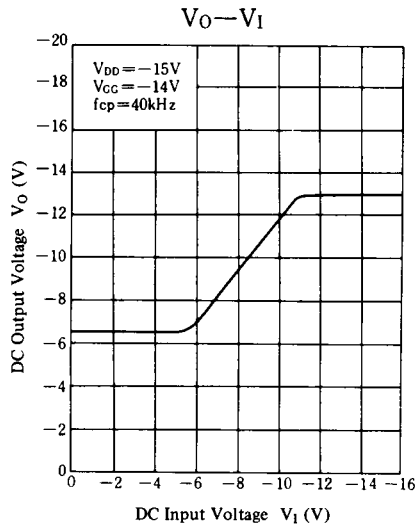

Supply Voltage Characteristics

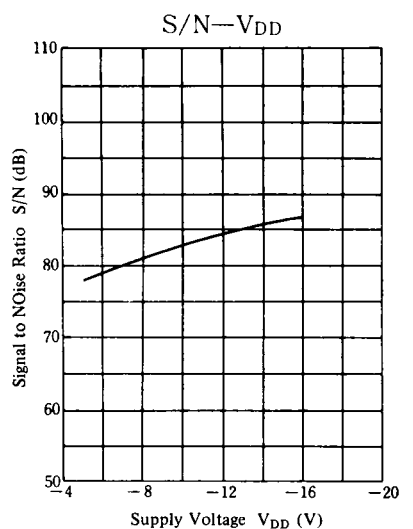
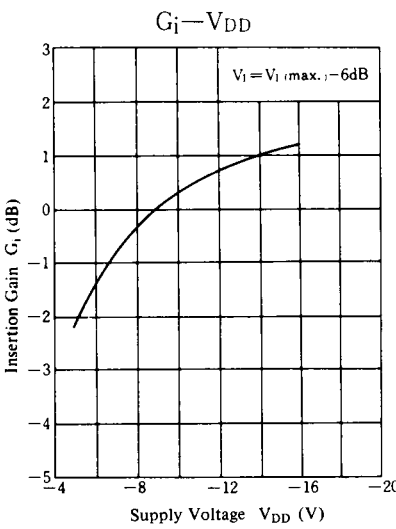
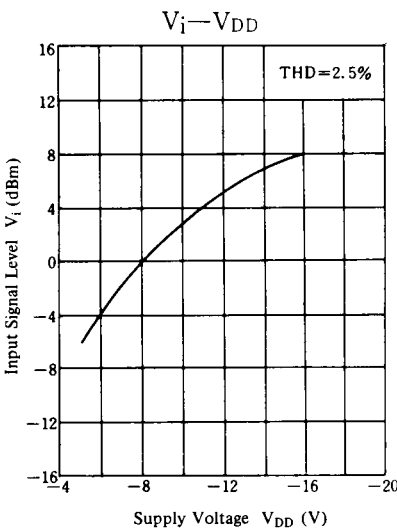
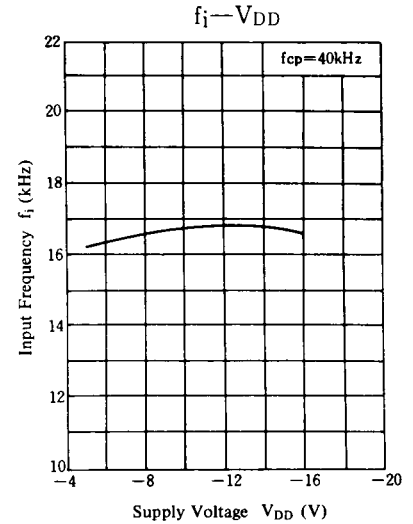
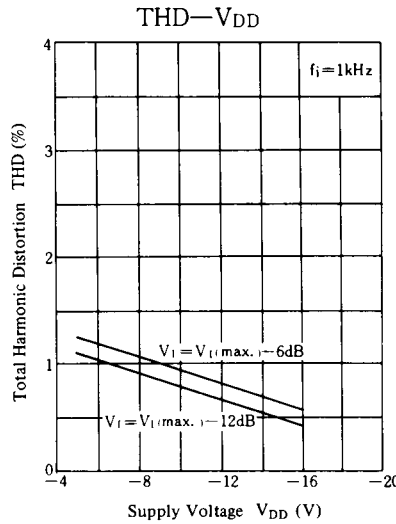
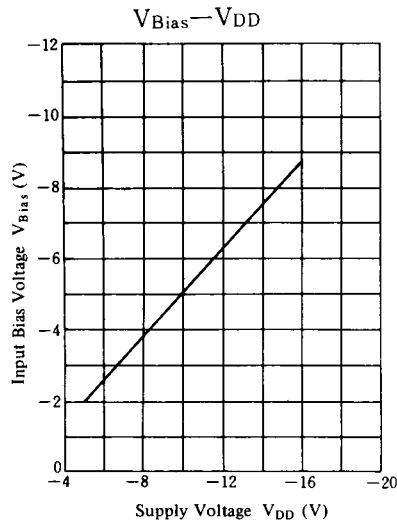

Example of application circuit

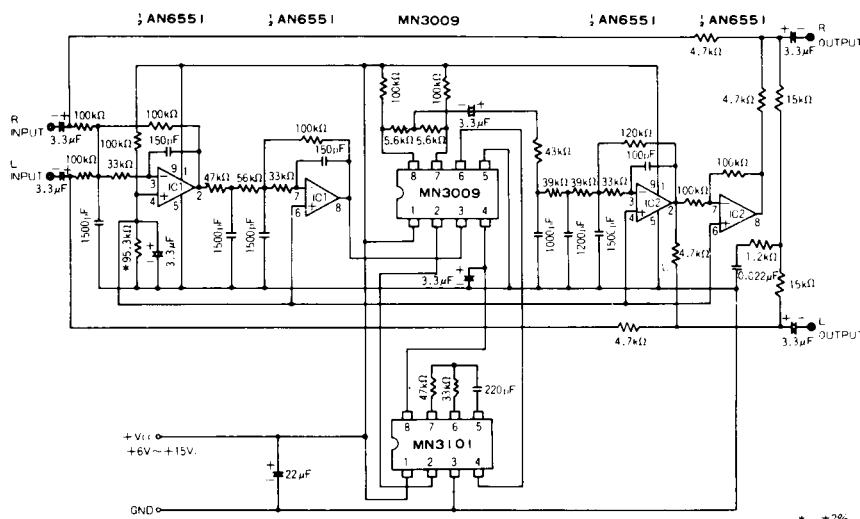

Sound field magnifying effect generating circuit

Sound field magnifying effect generating circuit

Isn't it really wonderful if the speaker reproduction of sound for a grand hall can be got in the listening room or the car? Application of the sound image control technology and the delay characteristic of the BBD makes it possible to realize the above effect easily. In listening through a speaker in the room, the listener feels the distance and direction up to the speaker. As to the directional sense, for instance, there occurs some difference in the time for both direct and indirect sounds to reach his left and right ears depending on the position of the sound source, as well as the difference in the sound level, and from these differences the listener feels the "direction of sound". Further he feels the "distance of sound" from the energy ratio of the direct sound to the indirect sound (reverberation sound). The circuit for generating a sound field magnifying effect reproduces electronically the delicate time lag of these sounds, thereby makes it possible for the listener to feel as if he hears sounds from his surroundings other than the position of the speaker, and thus producing such effect that he is listening sounds in a large hall. Also the fatigue from listening for a long time through a conventional headphone is eliminated, and the effect similar to that of listening through an ordinary speaker is obtained.