

FEATURES

- Low cost 3.3 V CMOS MxFE™ for MCNS-DOCSIS-, DVB-, DAVIC-compliant set-top box and cable modem applications
- 232 MHz quadrature digital upconverter
- 12-bit direct IF DAC (TxDAC+®)
- Up to 65 MHz carrier frequency DDS
- Programmable sampling clock rates
- Selectable interpolation filter
- Analog Tx output level adjust
- 12-bit, 33 MSPS direct IF ADC
- Dual 8-bit, 16.5 MSPS sampling IQ ADCs
- Two 12-bit Σ - Δ auxiliary DACs
- Direct interface to AD8321/AD8325 or AD8322/AD8327 PGA cable driver

APPLICATIONS

- Cable modems
- Set-top boxes
- Wireless modems

GENERAL DESCRIPTION

The AD9877 is a single-supply set-top box and cable modem mixed-signal front end. The device contains a transmit path interpolation filter, complete quadrature digital upconverter, and transmit DAC. The receive path contains a 12-bit ADC and dual 8-bit ADCs. All internally required clocks and an output system clock are generated by the phase-locked loop (PLL) from a single crystal or clock input.

The transmit path interpolation filter provides upsampling factors of 12 \times or 16 \times with an output signal bandwidth as high as 5.8 MHz. Carrier frequencies up to 65 MHz with 26 bits of frequency tuning resolution can be generated by the direct digital synthesizer (DDS). The transmit DAC resolution is 12 bits and can run at sampling rates as high as 232 MSPS. Analog output scaling from 0 dB to 7.5 dB in 0.5 dB steps is available to preserve SNR when reduced output levels are required.

Rev. B

Information furnished by Analog Devices is believed to be accurate and reliable. However, no responsibility is assumed by Analog Devices for its use, nor for any infringements of patents or other rights of third parties that may result from its use. Specifications subject to change without notice. No license is granted by implication or otherwise under any patent or patent rights of Analog Devices. Trademarks and registered trademarks are the property of their respective owners.

FUNCTIONAL BLOCK DIAGRAM

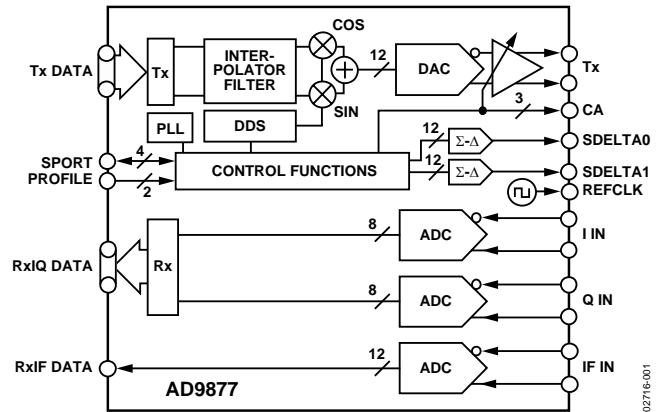

Figure 1.

The 12-bit ADC has excellent undersampling performance, allowing it to typically deliver better than 10 ENOBs with IF inputs up to 70 MHz. The 12-bit IF ADC can sample at a rate up to 33 MHz, allowing it to process wideband signal inputs. Two programmable Σ - Δ DACs are available and can be used to control external components, such as variable gain amplifiers (VGAs) or voltage-controlled tuners.

The AD9877 integrates a CA port that enables a host processor to control the AD8321/AD8325 or AD8322/AD8327 programmable gain amplifier (PGA) cable drivers via the MxFE SPORT.

The AD9877 is available in a 100-lead MQFP package. It offers enhanced receive path undersampling performance and lower cost compared to the pin-compatible AD9873. The AD9877 is specified over the extended industrial (-40°C to $+85^{\circ}\text{C}$) temperature range.

TABLE OF CONTENTS

Specifications.....	4	MSB/LSB Transfers	22
Absolute Maximum Ratings.....	7	Notes on Serial Port Operation	23
Explanation of Test Levels.....	7	Transmit Path (Tx).....	24
Thermal Characteristics	7	Transmit Timing.....	24
ESD Caution.....	7	Data Assembler.....	24
Pin Configuration and Function Descriptions.....	8	Half-Band Filters (HBFs)	24
Typical Performance Characteristics	10	Cascaded Integrator-Comb (CIC) Filter.....	24
Terminology	12	Combined Filter Response.....	25
Theory of Operation	13	Tx Signal Level Considerations.....	27
Transmit Section.....	13	Tx Throughput and Latency.....	27
Clock and Oscillator Circuitry	14	Digital-to-Analog Converter	27
Programmable Clock Output REFCLK.....	15	Programming the AD8321/AD8325 or AD8322/AD8327 Cable Driver Amplifier Gain Control.....	29
Reset and Transmit Power-Down	16	Receive Path (Rx)	30
Σ - Δ Outputs	17	ADC Theory of Operation.....	30
Register Map and Bit Definitions	18	Receive Timing.....	30
Register 0x00—Initialization	19	Driving the Analog Inputs	30
Register 0x01—Clock Configuration.....	19	Op Amp Selection Guide	31
Register 0x02—Power-Down.....	19	ADC Differential Inputs.....	31
Register 0x03–0x06— Σ - Δ Control Words.....	19	ADC Voltage References	32
Register 0x08—ADC Clock Configuration	20	PCB Design Considerations.....	33
Register 0x0C—Die Revision.....	20	Component Placement.....	33
Register 0x0D—Tx Frequency Tuning Words LSBs.....	20	Power Planes and Decoupling.....	33
Register 0x0E—DAC Gain Control	20	Ground Planes	33
Register 0x0F—Tx Path Configuration	20	Signal Routing.....	34
Registers 0x10–0x1F—Burst Parameter	20	Outline Dimensions	35
Serial Interface for Register Control	22	Ordering Guide	35
General Operation of the Serial Interface	22		
Instruction Byte	22		
Serial Interface Port Pin Description.....	22		

REVISION HISTORY

5/05—Rev. A to Rev. B

Updated Format..... Universal
Changed OSCOUT to REFCLK..... Universal
Changed REF CLK to REFCLK..... Universal
Changes to Specifications.....4
Changes to Figure 2423
Updated Outline Dimensions.....35
Changes to Ordering Guide.....35

7/02—Rev. 0 to Rev. A

Edits to ORDERING GUIDE 5
Edits to RESET AND TRANSMIT POWER-DOWN section.. 17

Revision 0: Initial Version

SPECIFICATIONS

$V_{AS} = 3.3 \text{ V} \pm 5\%$, $V_{DS} = 3.3 \text{ V} \pm 10\%$, $f_{OSCIN} = 27 \text{ MHz}$, $f_{SYSCLK} = 216 \text{ MHz}$, $f_{MCLK} = 54 \text{ MHz}$ ($M = 8$ and $N = 4$). ADC sample frequencies derived from PLL (f_{MCLK}), $R_{SET} = 4.02 \text{ k}\Omega$, maximum fine gain, $75 \text{ }\Omega$ DAC load.

Table 1.

Parameter	Temp	Test Level	Min	Typ	Max	Unit
SYSTEM CLOCK DAC SAMPLING, f_{SYSCLK}						
Frequency Range (N = 4)	Full	II			232	MHz
Frequency Range (N = 3)	Full	II			177	MHz
OSCIN and XTAL CHARACTERISTICS						
Frequency Range	Full	II	3		33	MHz
Duty Cycle	25°C	II	35	50	65	%
Input Impedance	25°C	III		100 3		$\text{M}\Omega \text{pF}$
MCLK JITTER						
Cycle to Cycle (f_{MCLK} derived from PLL)	25°C	III		6		ps rms
Tx DAC CHARACTERISTICS						
Resolution	N/A	N/A		12		Bits
Full-Scale Output Current	Full	II	4	10	20	mA
Gain Error (using internal reference)	Full	I	-2.5	-1	+2.5	% FS
Offset Error	25°C	I		± 1.0		% FS
Reference Voltage (REFIO Level)	25°C	I	1.18	1.23	1.28	V
Differential Nonlinearity (DNL)	25°C	III		± 2.5		LSB
Integral Nonlinearity (INL)	25°C	III		± 8		LSB
Output Capacitance	25°C	III		5		pF
Phase Noise @ 1 kHz Offset, 42 MHz Carrier	25°C	III		-110		dBc/Hz
Output Voltage Compliance Range	Full	II	-0.5		+1.5	V
Wideband SFDR						
5 MHz Analog Out, $I_{OUT} = 10 \text{ mA}$	Full	II	48	55		dBc
65 MHz Analog Out, $I_{OUT} = 10 \text{ mA}$	Full	II	48	51		dBc
Narrow-Band SFDR ($\pm 1 \text{ MHz}$ Window)						
65 MHz Analog Out, $I_{OUT} = 10 \text{ mA}$	Full	II	53	69		dBc
Tx MODULATOR CHARACTERISTICS						
I/Q Offset	Full	II	50	55		dB
Pass-Band Amplitude Ripple ($f < f_{IQCLK}/8$)	Full	II			± 0.1	dB
Pass-Band Amplitude Ripple ($f < f_{IQCLK}/4$)	Full	II			± 0.5	dB
Stop-Band Response ($f > f_{IQCLK} \times 3/4$)	Full	II			-63	dB
Tx GAIN CONTROL						
Gain Step Size	25°C	III		0.5		dB
Gain Step Error	25°C	III		0.05		dB
Settling Time, 1% (Full-Scale Step)	25°C	III		1.8		μs
8-BIT ADC CHARACTERISTICS						
Resolution	N/A	N/A		8		Bits
Conversion Rate	Full	II			16.5	MHz
Pipeline Delay	N/A	N/A		3.5		ADC cycles
Offset Matching Between I and Q ADCs				± 8.0		LSBs
Gain Matching Between I and Q ADCs				± 2.0		LSBs
Analog Input						
Input Voltage Range	Full	II		1		Vppd
Differential Input Impedance	25°C	III		4 2		$\text{k}\Omega \text{pF}$
Full Power Bandwidth	25°C	III		90		MHz
Input Referred Noise	25°C	III		600		μV

Parameter	Temp	Test Level	Min	Typ	Max	Unit
Dynamic Performance ($A_{IN} = -0.5$ dBFS, $f = 5$ MHz)						
Signal-to-Noise and Distortion (SINAD)	25°C	I	40.8	47.3		dB
Effective Number of Bits (ENOB)	25°C	I	6.5	7.6		Bits
Total Harmonic Distortion (THD)	25°C	I		-60.1	-50.0	dB
Spurious-Free Dynamic Range (SFDR)	25°C	I	52.0	63.0		dB
Reference Voltage Error						
REFT8 to REFB8 (0.5 V)	25°C	I	-100	±10	+100	mV
12-BIT ADC CHARACTERISTICS						
Resolution	N/A	N/A		12		Bits
Conversion Rate	Full	II			33	MHz
Pipeline Delay	N/A	N/A		5.5		ADC cycles
Analog Input						
Input Voltage Range	Full	III		2		Vppd
Differential Input Impedance	25°C	III		4 2		kΩ pF
Aperture Delay	25°C	III		2.0		ns
Aperture Uncertainty (Jitter)	25°C	III		1.2		ps rms
Full-Power Bandwidth	25°C	III		85		MHz
Input Referred Noise	25°C	III		75		μV
Reference Voltage Error						
REFT12 to REFB12 (1 V)	25°C	I	-200	±16	±200	mV
Dynamic Performance ($A_{IN} = -0.5$ dBFS, $f = 5$ MHz)						
ADC Sample Clock = OSCIN						
Signal-to-Noise and Distortion (SINAD)	Full	II	63.2	65.9		dB
Effective Number of Bits (ENOBs)	Full	II	10.2	10.7		Bits
Signal-to-Noise Ratio (SNR)	Full	II	63.7	66.2		dB
Total Harmonic Distortion (THD)	Full	II		-79.1	-68.3	dB
Spurious-Free Dynamic Range (SFDR)	Full	II	72.5	79.3		dB
ADC Sample Clock = PLL						
Signal-to-Noise and Distortion (SINAD)	Full	II	62.0	64.6		dB
Effective Number of Bits (ENOBs)	Full	II	10.0	10.4		Bits
Signal-to-Noise Ratio (SNR)	Full	II	62.5	64.8		dB
Total Harmonic Distortion (THD)	Full	II		-78	-67.8	dB
Spurious-Free Dynamic Range (SFDR)	Full	II	71.0	78.9		dB
Dynamic Performance ($A_{IN} = -0.5$ dBFS, $f = 50$ MHz)						
ADC Sample Clock = OSCIN						
Signal-to-Noise and Distortion (SINAD)	Full	II	61.1	63.1		dB
Effective Number of Bits (ENOB)	Full	II	9.9	10.2		Bits
Signal-to-Noise Ratio (SNR)	Full	II	61.5	63.3		dB
Total Harmonic Distortion (THD)	Full	II		-77	-67.9	dB
Spurious-Free Dynamic Range (SFDR)	Full	II	69.9	79.6		dB
Differential Phase	25°C	III		<0.1		Degrees
Differential Gain	25°C	III		<1		LSB
CHANNEL-TO-CHANNEL ISOLATION						
Tx DAC-to-ADC Isolation (5 MHz Analog Output)						
Isolation Between Tx and 8-Bit ADCs	25°C	III		80		dB
Isolation Between Tx and 12-Bit ADCs	25°C	III		90		dB
ADC-to-ADC Isolation						
($A_{IN} = -0.5$ dBFS, $f = 5$ MHz)						
Isolation Between I/Q in and IF12	25°C	III		70		dB
Isolation Between Q and I Inputs	25°C	III		65		dB

AD9877

Parameter	Temp	Test Level	Min	Typ	Max	Unit
TIMING CHARACTERISTICS (10 pF Load)						
Wake-Up Time	N/A	N/A			200	t _{MCLK} cycles
Minimum $\overline{\text{RESET}}$ Pulse Width Low (t _{RL})	N/A	N/A	5			t _{MCLK} cycles
Digital Output Rise/Fall Time	Full	II	2.8		4	ns
Tx/Rx Interface						
MCLK Frequency (f _{MCLK})	Full	II			66	MHz
TxSYNC/TxIQ Setup Time (t _{SU})	Full	II	3			ns
TxSYNC/TxIQ Hold Time (t _{HD})	Full	II	3			ns
MCLK Rising Edge to RxSYNC/RxIQ/IF Valid Delay (t _{MD})	Full	II	0		1.0	ns
REFCLK Rising or Falling Edge to RxSYNC/RxIQ/IF Valid Delay (t _{OD})	Full	II	T _{OSC} /4 – 2.0		T _{OSC} /4 + 3.0	ns
REFCLK Edge to MCLK Falling Edge (t _{EE})	Full	II	–1.0		+1.0	ns
Serial Control Bus						
Maximum SCLK Frequency (f _{SCLK})	Full	II			15	MHz
Minimum Clock Pulse Width High (t _{PWH})	Full	II	30			ns
Minimum Clock Pulse Width Low (t _{PWL})	Full	II	30			ns
Maximum Clock Rise/Fall	Full	II			1	μs
Minimum Data/Chip-Select Setup Time (t _{DS})	Full	II	25			ns
Minimum Data Hold Time (t _{DH})	Full	II	0			ns
Maximum Data Valid Time (t _{DV})	Full	II			30	ns
CMOS LOGIC INPUTS						
Logic 1 Voltage	25°C	II	DRVDD – 0.7			V
Logic 0 Voltage	25°C	II			0.4	V
Logic 1 Current	25°C	II			12	μA
Logic 0 Current	25°C	II			12	μA
Input Capacitance	25°C	III		3		pF
CMOS LOGIC OUTPUTS (1 mA Load)						
Logic 1 Voltage	25°C	II	DRVDD – 0.6			V
Logic 0 Voltage	25°C	II			0.4	V
POWER SUPPLY						
Supply Current, I _S (Full Operation)	25°C	II		233	272	mA
Analog Supply Current, I _{AS}	25°C	III		85		mA
Digital Supply Current, I _{DS}	25°C	III		228		mA
Supply Current, I _S						
Standby ($\overline{\text{PWRDN}}$ Pin Active)	25°C	I		104	113	mA
Full Power-Down (Register 0x02 = 0xF9)	25°C	III		10		mA
Power-Down Tx Path (Register 0x02 = 0x20)	25°C	III		60		mA
Power-Down Rx Path (Register 0x02 = 0x19)	25°C	III		265		mA
Reset ($\overline{\text{RESET}}$ Pin Active)	25°C	III		85		mA
Power Supply Rejection (Differential Signal)						
Tx DAC	25°C	III		<0.25		% FS
8-Bit ADC	25°C	III		<0.004		% FS
12-Bit ADC	25°C	III		<0.0004		% FS

ABSOLUTE MAXIMUM RATINGS

Table 2.

Parameters	Ratings
Power Supply (V_{AVDD} , V_{DVDD} , V_{DRVDD})	3.9 V
Digital Output Current	5 mA
Digital Inputs	-0.3 V to $DRVDD + 0.3$ V
Analog Inputs	-0.3 V to $AVDD + 0.3$ V
Operating Temperature	-40°C to +85°C
Maximum Junction Temperature	150°C
Storage Temperature	-65°C to +150°C
Lead Temperature (Soldering, 10 sec)	300°C

Stresses above those listed under Absolute Maximum Ratings may cause permanent damage to the device. This is a stress rating only; functional operation of the device at these or any other conditions above those indicated in the operational section of this specification is not implied. Exposure to absolute maximum rating conditions for extended periods may affect device reliability.

ESD CAUTION

ESD (electrostatic discharge) sensitive device. Electrostatic charges as high as 4000 V readily accumulate on the human body and test equipment and can discharge without detection. Although this product features proprietary ESD protection circuitry, permanent damage may occur on devices subjected to high energy electrostatic discharges. Therefore, proper ESD precautions are recommended to avoid performance degradation or loss of functionality.

EXPLANATION OF TEST LEVELS

- I Devices are 100% production tested at 25°C and guaranteed by design and characterization testing for industrial operating temperature range (-40°C to +85°C).
- II Parameter is guaranteed by design and/or characterization testing.
- III Parameter is a typical value only.
- N/A Test level definition is not applicable.

THERMAL CHARACTERISTICS

Thermal Resistance

100-Lead MQFP
 $\theta_{JA} = 40.5^{\circ}\text{C/W}$



PIN CONFIGURATION AND FUNCTION DESCRIPTIONS

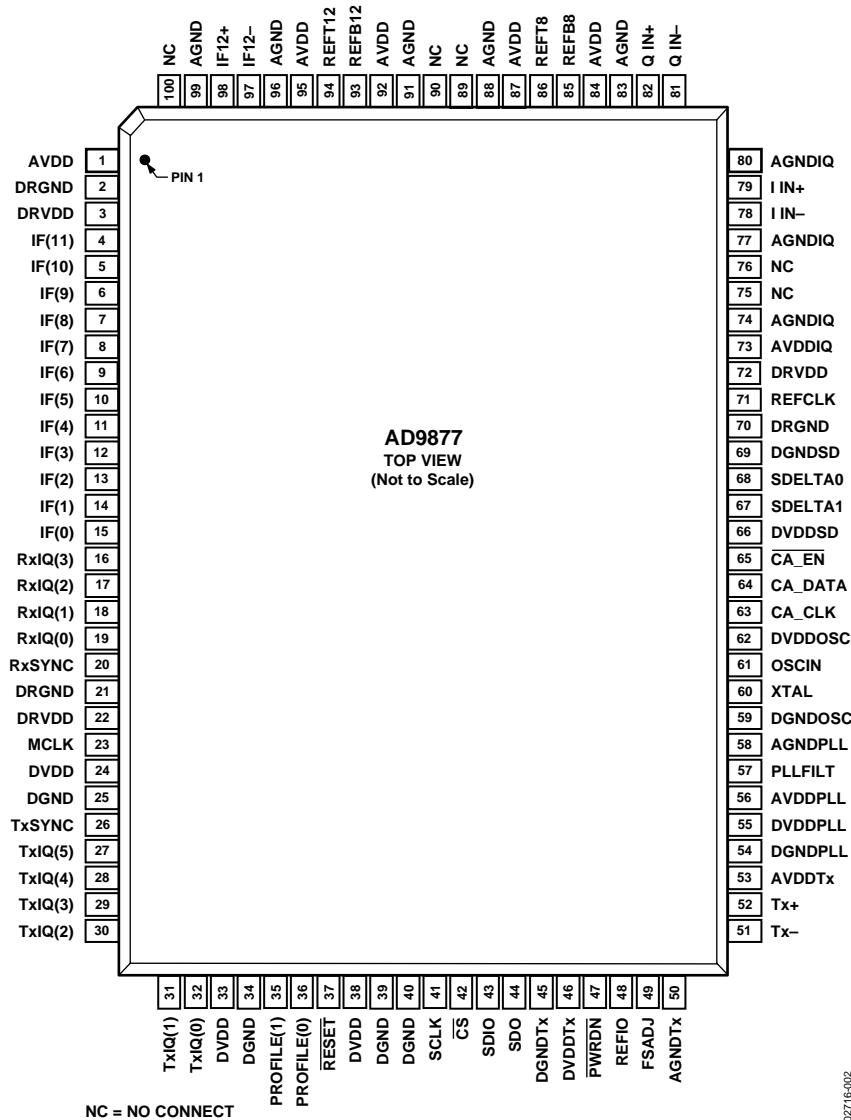

Figure 2. Pin Configuration

Table 3. Pin Function Descriptions

Pin No.	Mnemonic	Description
1, 84, 87, 92, 95	AVDD	12-Bit ADC Analog 3.3 V Supply.
2, 21, 70	DRGND	Pin Driver Digital Ground.
3, 22, 72	DRVDD	Pin Driver Digital 3.3 V Supply.
25, 34, 39, 40	DGND	Digital Ground.
24, 33, 38	DVDD	Digital 3.3 V Supply.
45	DGNDTx	Tx Path Digital Ground.
46	DVDDTx	Tx Path Digital 3.3 V Supply.
50	AGNDTx	Tx Path Analog Ground.
53	AVDDTx	Tx Path Analog 3.3 V Supply.
54	DGNDPLL	PLL Digital Ground.
55	DVDDPLL	PLL Digital 3.3 V Supply.
56	AVDDPLL	PLL Analog 3.3 V Supply.
58	AGNDPLL	PLL Analog Ground.

Pin No.	Mnemonic	Description
59	DGNDOSC	Oscillator Digital Ground.
62	DVDDOSC	Oscillator Digital 3.3 V Supply.
66	DVDDSD	Σ - Δ Digital 3.3 V Supply.
69	DGNDSD	Σ - Δ Digital Ground.
73	AVDDIQ	8-Bit ADC Analog 3.3 V Supply.
74, 77, 80	AGNDIQ	8-Bit ADC Analog Ground.
83, 88, 91, 96, 99	AGND	12-Bit ADC Analog Ground.
4:15	IF[1:0]	12-Bit ADC Digital Output.
16:19	RxIQ[3:0]	Muxed I and Q ADC Output.
20	RxSYNC	Sync Output, IF, I, and Q ADCs.
23	MCLK	Master Clock Output.
26	TxSYNC	Sync Input for Transmit Port.
27:32	TxIQ[5:0]	Digital Input for Transmit Port.
35, 36	PROFILE[1:0]	Profile Selection Inputs.
37	RESET	Chip Reset Input.
41	SCLK	SPORT Clock.
42	\overline{CS}	SPORT Chip Select.
43	SDIO	SPORT Data I/O.
44	SDO	SPORT Data Output.
47	\overline{PWRDN}	Power-Down Transmit Path.
48	REFIO	TxDAC Decoupling (to AGND).
49	FSADJ	DAC Output Adjust (External Resistor).
51, 52	Tx-, Tx+	Tx Path Complementary Outputs.
57	PLLFLT	PLL Loop Filter Connection.
60	XTAL	Crystal Oscillator Inverse Output.
61	OSCIN	Oscillator Clock Input.
63	CA_CLK	Serial Clock to Cable Driver.
64	CA_DATA	Serial Data to Cable Driver.
65	$\overline{CA_EN}$	Serial Enable to Cable Driver.
67	SDELTA1	Σ - Δ Output Stream1.
68	SDELTA0	Σ - Δ Output Stream0.
71	REFCLK	Programmable Reference Clock Output.
75, 76, 89, 90, 100	NC	No Connect (Leave Floating).
78, 79	I IN-, I IN+	Differential Input to I ADC.
81, 82	Q IN-, Q IN+	Differential Input to Q ADC.
85	REFB8	8-Bit ADC Decoupling Node.
86	REFT8	8-Bit ADC Decoupling Node.
93	REFB12	12-Bit ADC Decoupling Node.
94	REFT12	12-Bit ADC Decoupling Node.
97, 98	IF12-, IF12+	Differential Input to IF ADC.

TYPICAL PERFORMANCE CHARACTERISTICS

$V_{AS} = 3.3\text{ V}$, $V_{DS} = 3.3\text{ V}$, $f_{OSCIN} = 27\text{ MHz}$, $f_{SYSCLK} = 216\text{ MHz}$, $f_{MCLK} = 54\text{ MHz}$ ($M = 8$ and $N = 4$). ADC sample rate derived directly from f_{OSCIN} , $R_{SET} = 4.02\text{ k}\Omega$ ($I_{OUT} = 10\text{ mA}$), and $75\ \Omega$ DAC load, unless otherwise noted.

TYPICAL POWER CONSUMPTION CHARACTERISTICS

Transmitted 20 MHz single tone, unless otherwise noted.

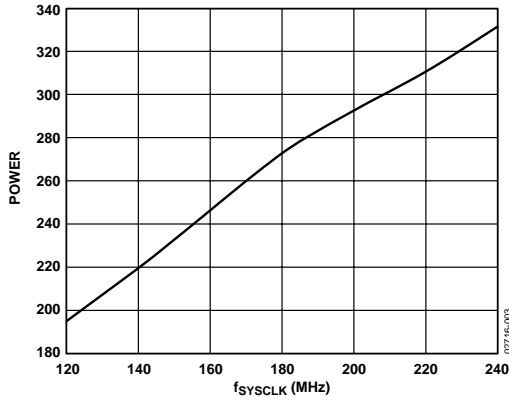

Figure 3. Power Consumption vs. Clock Speed, f_{SYSCLK}

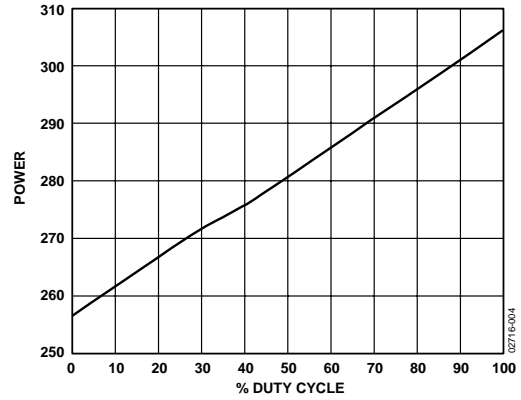

Figure 4. Power Consumption vs. Transmit Burst Duty Cycle

DUAL SIDEBAND TRANSMIT SPECTRUM

See Table 11 for dual-tone generation.

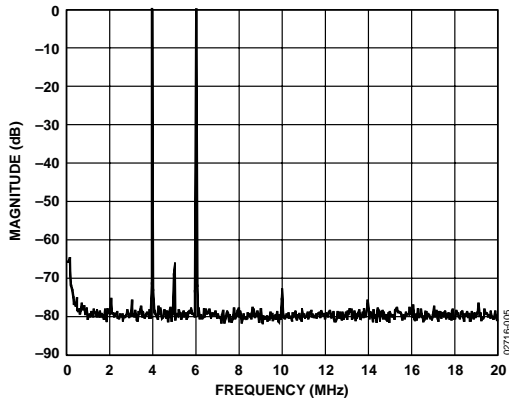

Figure 5. Dual Sideband Spectral Plot, $f_c = 5\text{ MHz}$, $f = 1\text{ MHz}$, $R_{SET} = 4.02\text{ K}\Omega$, DAC Gain = 7.5 dB, RBW = 1 kHz

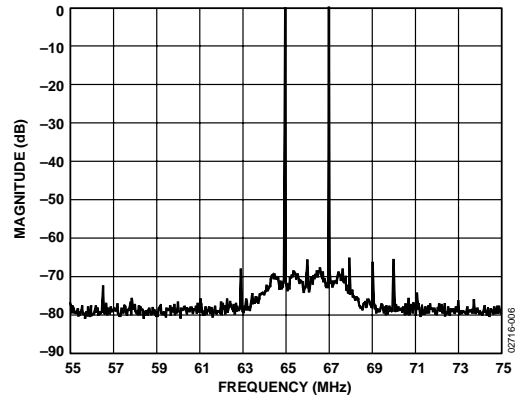

Figure 6. Dual Sideband Spectral Plot, $f_c = 65\text{ MHz}$, $f = 1\text{ MHz}$, $R_{SET} = 4.02\text{ K}\Omega$, ($I_{OUT} = 10\text{ mA}$), RBW = 1 kHz

SINGLE SIDEBAND TRANSMIT SPECTRUM

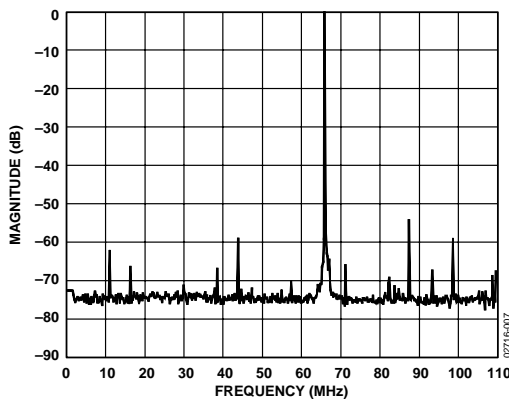

Figure 7. Single Sideband @ 65 MHz, RBW = 2 kHz, $f_c = 66\text{ MHz}$, $f = 1\text{ MHz}$, $R_{SET} = 4.02\text{ K}\Omega$, DAC gain = 7.5 dB

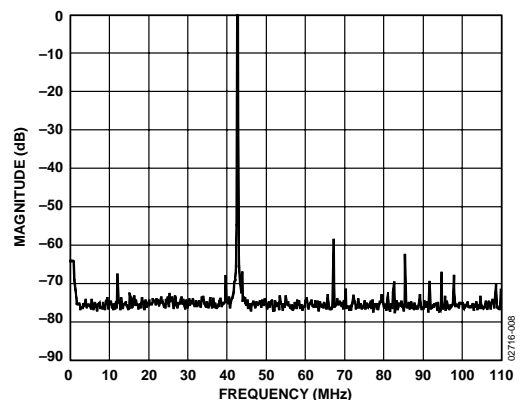

Figure 8. Single Sideband @ 42 MHz, RBW = 2 kHz, $f_c = 43\text{ MHz}$, $f = 1\text{ MHz}$, $R_{SET} = 4.02\text{ K}\Omega$, DAC gain = 7.5 dB

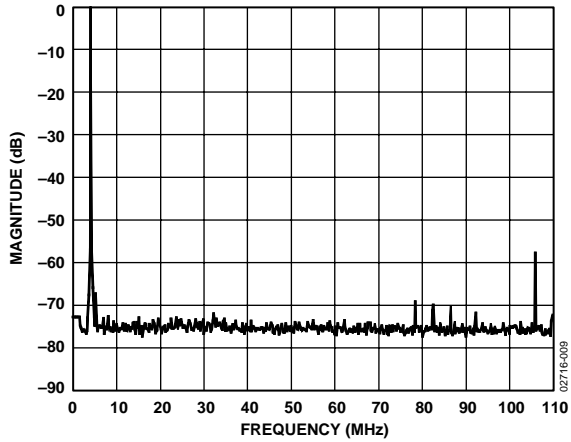

Figure 9. Single Sideband @ 5 MHz, RBW = 2 kHz, $f_c = 6$ MHz, $f = 1$ MHz, $R_{SET} = 4.02$ K Ω , DAC gain = 7.5 dB

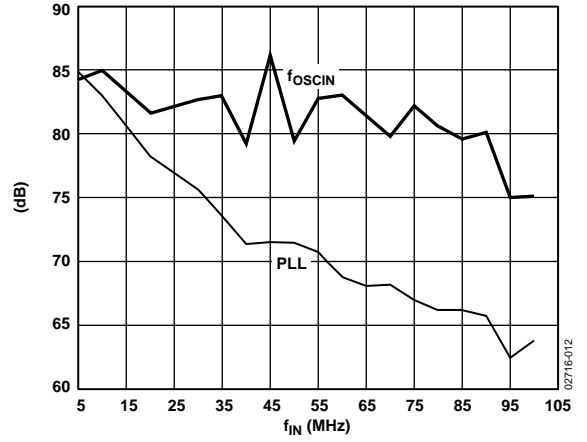

Figure 12. 12-Bit ADC SFDR vs. Input Frequency

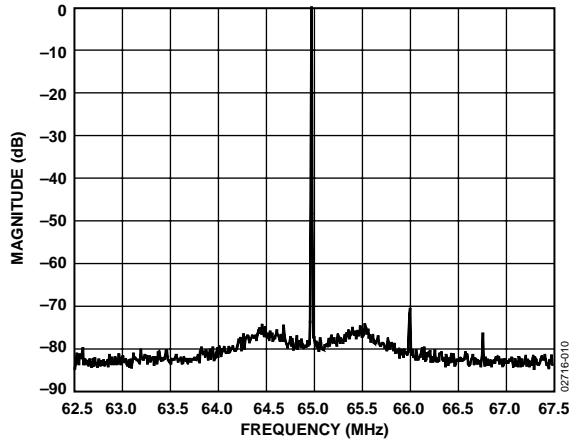

Figure 10. Single Sideband @ 65 MHz, RBW = 500 Hz, $f_c = 66$ MHz, $f = 1$ MHz, $R_{SET} = 4.02$ K Ω , DAC gain = 7.5 dB

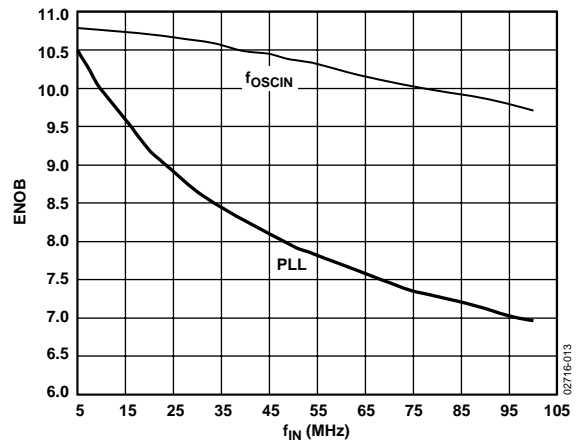

Figure 13. 12-Bit ADC ENOBs vs. Input Frequency

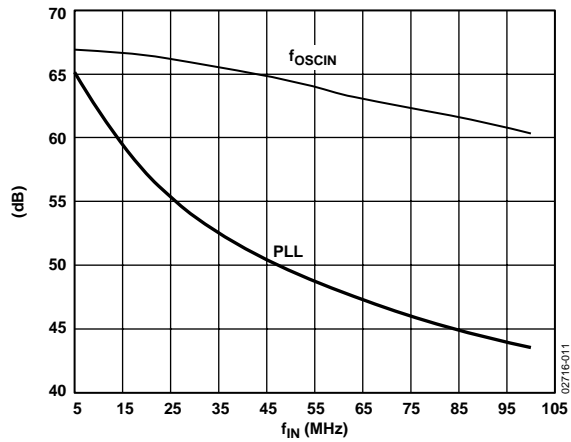

Figure 11. 12-Bit ADC SNR vs. Input Frequency

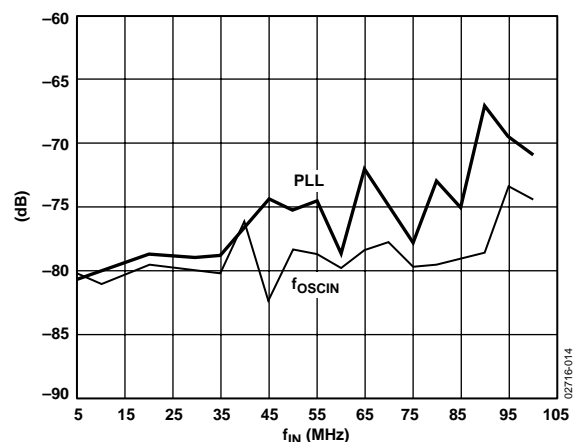

Figure 14. 12-Bit ADC THD vs. Input Frequency

TERMINOLOGY

Aperture Delay

The aperture delay is a measure of the sample-and-hold amplifier (SHA) performance. It specifies the time delay between the rising edge of the sampling clock input and when the input signal is held for conversion.

Aperture Uncertainty (Jitter)

Aperture jitter is the variation in aperture delay for successive samples. It is manifested as noise on the input to the ADC.

Channel-to-Channel Isolation (Crosstalk)

In an ideal multichannel system, the signal in one channel does not influence the signal level of another channel. The channel-to-channel isolation specification is a measure of the change that occurs to a grounded channel as a full-scale signal is applied to another channel.

Differential Nonlinearity Error (DNL, No Missing Codes)

An ideal converter exhibits code transitions that are exactly 1 LSB apart. DNL is the deviation from this ideal value. Guaranteed no missing codes to 10-bit resolution indicates that all 1,024 codes, respectively, must be present over all operating ranges.

Effective Number of Bits (ENOB)

For a sine wave, *SINAD* can be expressed in terms of the number of bits. Using the formula

$$N = (\text{SINAD} - 1.76 \text{ dB}/6.02)$$

it is possible to determine a measure of performance expressed as *N*, the effective number of bits. Thus, the effective number of bits for a device's sine wave inputs at a given input frequency can be calculated directly from its measured *SINAD*.

Gain Error

The first code transition should occur at an analog value 1/2 LSB above full scale. The last transition should occur for an analog value 1 1/2 LSB below the nominal full scale. Gain error is the deviation of the actual difference between the first and last code transitions and the ideal difference between the first and last code transitions.

Input Referred Noise

The rms output noise is measured using histogram techniques. The standard deviation of the ADC output code is calculated in LSB and converted to an equivalent voltage. This results in a noise figure that can be directly referred to the input of the MxFE.

Integral Nonlinearity Error (INL)

Linearity error refers to the deviation of each individual code from a line drawn from negative full scale through the positive full scale. The point used as the negative full scale occurs 1/2 LSB before the first code transition. Positive full scale is defined as a level 1 1/2 LSB beyond the last code transition. The deviation is measured from the middle of each code to the true straight line.

Offset Error

First transition should occur for an analog value 1/2 LSB above $-FS$. Offset error is defined as the deviation of the actual transition from that point.

Output Compliance Range

The range of allowable voltage at the output of a current-output DAC. Operation beyond the maximum compliance limits can cause either output stage saturation or break down, resulting in nonlinear performance.

Phase Noise

Single-sideband phase noise power is specified relative to the carrier (dBc/Hz) at a given frequency offset (1 kHz) from the carrier. Phase noise can be measured directly in single-tone transmit mode with a spectrum analyzer that supports noise marker measurements. It detects the relative power between the carrier and the offset (1 kHz) sideband noise and takes the resolution bandwidth (RBW) into account by subtracting $10 \log(\text{RBW})$. It also adds a correction factor that compensates for the implementation of the resolution bandwidth, log display, and detector characteristic.

Pipeline Delay (Latency)

Pipeline delay is the number of clock cycles between conversion initiation and the availability of the associated output data.

Power Supply Rejection

Power supply rejection specifies the converter's maximum full-scale change when the supplies are varied from nominal to minimum and maximum specified voltages.

Signal-to-Noise and Distortion (SINAD) Ratio

SINAD is the ratio of the rms value of the measured input signal to the rms sum of all other spectral components below the Nyquist frequency, including harmonics but excluding dc. The value for *SINAD* is expressed in decibels.

Signal-to-Noise Ratio (SNR)

SNR is the ratio of the rms value of the measured input signal to the rms sum of all other spectral components below the Nyquist frequency, excluding harmonics and dc. The value for *SNR* is expressed in decibels.

Spurious-Free Dynamic Range (SFDR)

SFDR is the difference, in dB, between the rms amplitude of the DAC output signal (or the ADC input signal) and the peak spurious signal over the specified bandwidth (Nyquist bandwidth, unless otherwise noted).

Total Harmonic Distortion (THD)

THD is the ratio of the rms sum of the first six harmonic components to the rms value of the measured input signal and is expressed as a percentage or in decibels.

THEORY OF OPERATION

To gain a general understanding of the AD9877, refer to the block diagram of the device architecture in Figure 15. The following is a general description of the device functionality. Later sections will detail each of the data path building blocks.

TRANSMIT SECTION

Modulation Mode Operation

The AD9877 accepts 6-bit words that are strobed synchronous to the master clock, MCLK, into the data assembler. A high level on TxSYNC signals the start of a transmit symbol. Two successive 6-bit words form a 12-bit symbol component. The incoming data is assumed to be complex in that alternating 12-bit words are regarded as the in-phase (I) and quadrature (Q) components of a symbol. Symbol components are assumed to be in twos complement format. The rate at which the TxIQ data is read will be referred to as the master clock rate (f_{MCLK}).

The data assembler receives the multiplexed IQ data and creates two parallel 12-bit paths with I and Q data pairs, which compose a complex symbol. The rate at which the I and Q data-word pairs appear at the output of the data assembler are referred to as the IQ sample rate (f_{IQCLK}). Because four 6-bit reads are required at the TxIQ input to read a full 24-bit complex symbol, f_{MCLK} is 4 times the IQ sample rate ($f_{MCLK} = 4 \times f_{IQCLK}$).

Once through the data assembler, the IQ data streams are fed through two half-band filters (Half-Band Filters 1 and 2). The combination of these two filters results in the sample rate increasing by a factor of 4. Thus, at the output of Half-Band Filter 2, the sample rate is $4 \times f_{IQCLK}$. In addition to the sample rate increase, the half-band filters provide the low-pass filtering characteristic necessary to suppress the spectral images produced by the upsampling process.

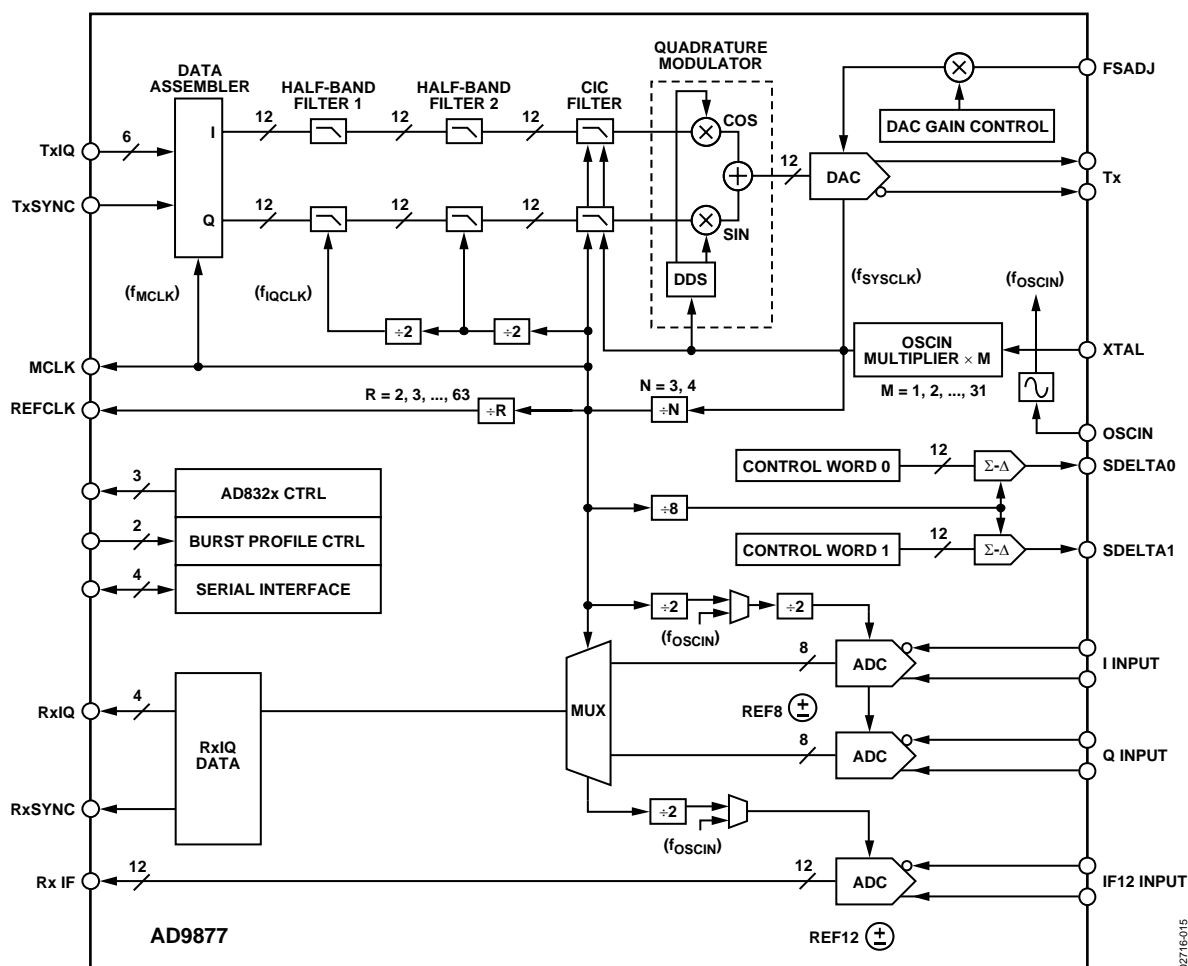

Figure 15. Block Diagram

After passing through the half-band filter stages, the IQ data streams are fed to a cascaded integrator-comb (CIC) filter. This filter is configured as an interpolating filter, which allows further upsampling rates of 3 or 4. The CIC filter, like the half-bands, has a built-in low-pass characteristic. Again, this provides for suppression of the spectral images produced by the upsampling process.

The digital quadrature modulator stage following the CIC filters is used to frequency shift (upconvert) the baseband spectrum of the incoming data stream up to the desired carrier frequency.

The carrier frequency is controlled numerically by a direct digital synthesizer (DDS). The DDS uses the internal system clock (f_{SYSCLK}) to generate the desired carrier frequency with a high degree of precision. The carrier is applied to the I and Q multipliers in quadrature fashion (90° phase offset) and summed to yield a data stream that is the modulated carrier.

It should be noted at this point that the incoming data has been converted from an input sample rate of f_{MCLK} to an output sample rate of f_{SYSCLK} (see Figure 15). The modulated carrier becomes the 12-bit samples sent to the DAC.

Single-Tone Output Transmit Operation

The AD9877 can be configured for frequency synthesis applications by writing the single-tone bit true. In single-tone mode, the AD9877 disengages the modulator and preceding data path logic to output a spectrally pure single-frequency sine wave. The AD9877 provides for a 26-bit frequency tuning word, which results in a tuning resolution of 3.2 Hz at a f_{SYSCLK} rate of 216 MHz. A good rule when using the AD9877 as a frequency synthesizer is to limit the fundamental output frequency to 30% of f_{SYSCLK} . This avoids generating aliases too close to the desired fundamental output frequency, thus minimizing the cost of filtering the aliases.

Frequency hopping via the profile inputs and associated tuning word is also supported in single-tone mode, which allows frequency shift keying (FSK) modulation.

OSCIN Clock Multiplier

As mentioned earlier, the output data is sampled at the rate of f_{SYSCLK} . The AD9877 has a built-in programmable clock multiplier and an oscillator circuit. This allows the use of a relatively low frequency, and therefore less expensive, crystal or oscillator to generate the OSCIN signal. The low frequency OSCIN signal can then be multiplied in frequency by an integer factor of between 1 and 31, inclusive, to become the f_{SYSCLK} clock.

For DDS applications, the carrier is typically limited to about 30% of f_{SYSCLK} . For a 65 MHz carrier, the system clock required is above 216 MHz.

The OSCIN multiplier function maintains clock integrity, as evidenced by the excellent phase noise characteristics and low

clock-related spur in the output spectrum of the AD9877. External loop filter components consisting of a series resistor (1.3 k Ω) and capacitor (0.01 μF) provide the compensation zero for the OSCIN multiplier PLL loop. The overall loop performance has been optimized for these component values.

Receive Section

The AD9877 includes three high speed, high performance ADCs. Two matched 8-bit ADCs are optimized for analog IQ demodulated signals and can be sampled at rates up to 16.5 MSPS. A direct IF 12-bit ADC can sample signals at rates up to 33 MSPS.

The ADC sampling frequency can be derived directly from the OSCIN signal or from the on-chip OSCIN multiplier. For highest dynamic performance, it is recommended to choose an OSCIN frequency that can be directly used as the ADC sampling clock. Digital 8-bit ADC outputs are multiplexed to one 4-bit bus, clocked by the master clock (MCLK). The 12-bit ADC uses a nonmultiplexed 12-bit interface with an output data rate of half the f_{MCLK} frequency.

CLOCK AND OSCILLATOR CIRCUITRY

The internal oscillator of the AD9877 generates all sampling clocks from a simple, low cost, parallel resonance, fundamental frequency quartz crystal. Figure 16 shows how the quartz crystal is connected between OSCIN (Pin 61) and XTAL (Pin 60) with parallel resonant load capacitors as specified by the crystal manufacturer. The internal oscillator circuitry can also be overdriven by a clock applied to OSCIN with XTAL left unconnected.

$$f_{\text{OSCIN}} = f_{\text{MCLK}} \times N/M$$

An internal phase-locked loop (PLL) generates the DAC sampling frequency, f_{SYSCLK} , by multiplying OSCIN frequency M times. The MCLK signal (Pin 23), f_{MCLK} , is derived by dividing this PLL output frequency by N (Register Address 0x01).

$$f_{\text{SYSCLK}} = f_{\text{OSCIN}} \times M$$

$$f_{\text{MCLK}} = f_{\text{OSCIN}} \times M/N$$

An external PLL loop filter (Pin 57) consisting of a series resistor and ceramic capacitor (Figure 16, $R_1 = 1.3 \text{ k}\Omega$, $C_{12} = 0.01 \mu\text{F}$) is required for stability of the PLL. Also, a shield surrounding these components is recommended to minimize external noise coupling into the PLL's voltage-controlled oscillator input (guard trace connected to AVDDPLL).

Figure 15 shows that ADCs are either sampled directly by a low jitter clock at OSCIN or by a clock that is derived from the PLL output. Operating modes can be selected in Register 0x08. Sampling the ADCs directly with the OSCIN clock requires MCLK to be programmed at twice the OSCIN frequency.

PROGRAMMABLE CLOCK OUTPUT REFCLK

The AD9877 provides a frequency-programmable clock output REFCLK (Pin 71). OSCIN or MCLK (f_{MCLK}) and the master clock divider ratio R stored in Register Address 0x01 determine its frequency.

$$f_{OSCOUT} = f_{MCLK}/R \text{ or } f_{OSCIN}$$

In its default setting (0x00 in Register 0x01), the REFCLK pin provides a buffered output of f_{OSCIN} .

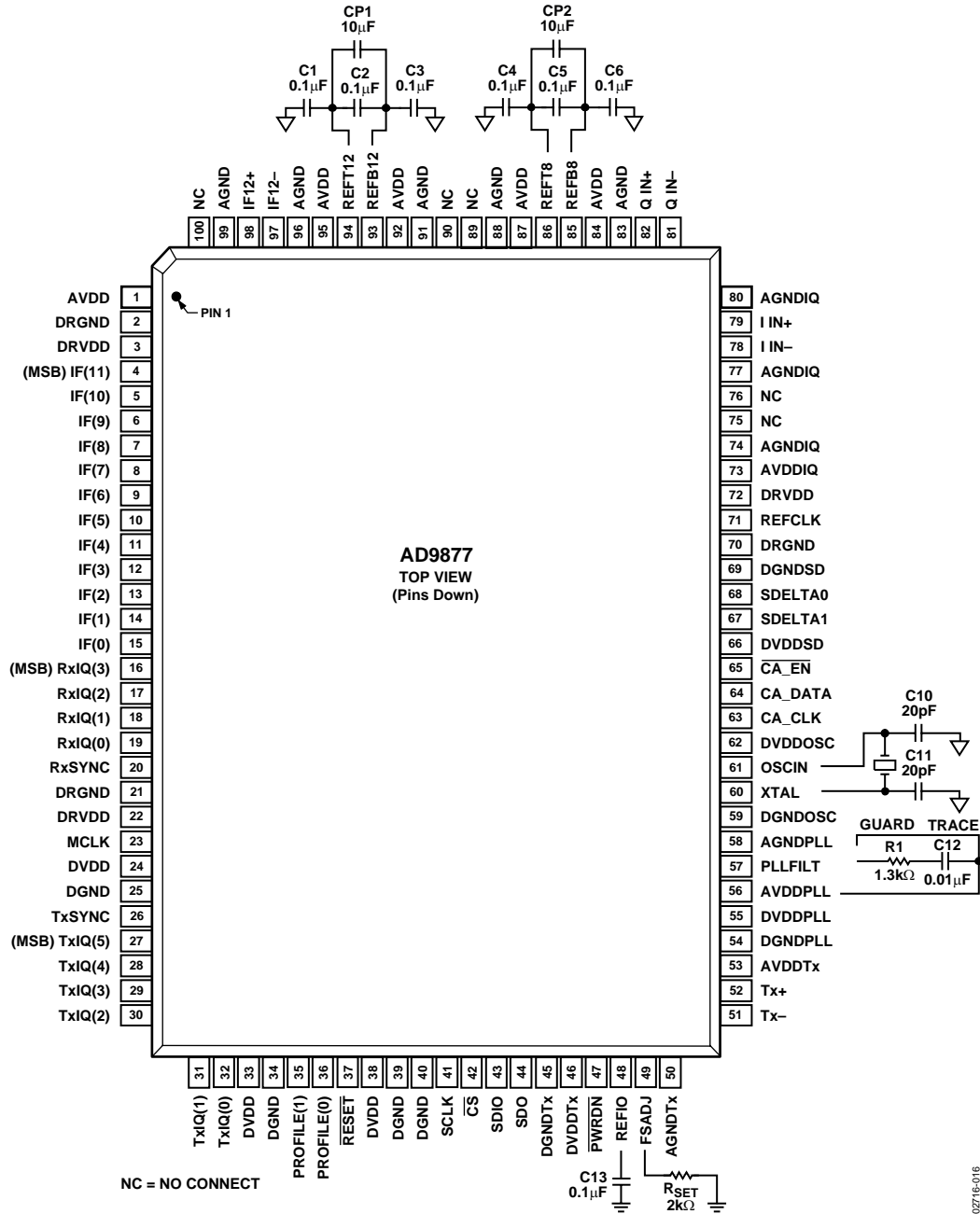

Figure 16. Basic Connection Diagram

RESET AND TRANSMIT POWER-DOWN

Power-Up Sequence

On initial power-up, the $\overline{\text{RESET}}$ pin should be held low until the power supply is stable.

Once $\overline{\text{RESET}}$ is deasserted, the AD9877 can be programmed over the serial port. It is recommended that the $\overline{\text{PWRDN}}$ pin be held low during the reset. Changes to ADC Clock Select (Register 0x08) or SYS Clock Divider N (Register 0x01) should be programmed before the rising edge of $\overline{\text{PWRDN}}$. Changes to the multiplier (M) will require the PLL to reacquire the new frequency, which can take up to 1 ms.

Once the PLL is frequency-locked and after the $\overline{\text{PWRDN}}$ pin is brought high, transmit data can be sent reliably.

If the $\overline{\text{PWRDN}}$ pin cannot be held low throughout the reset and PLL settling time period, the Power-Down Digital Tx bit or the $\overline{\text{PWRDN}}$ pin should be pulsed after the PLL has settled. This will ensure correct transmit filter initialization.

RESET

To initiate a hardware reset, the $\overline{\text{RESET}}$ pin should be held low for at least 100 ns. All internally generated clocks except REFCLK stop during reset. The MCLK signal begins transmission three clock cycles after reset. The rising edge of $\overline{\text{RESET}}$ reinitializes the programmable registers to their default values. The same sequence as described in the Power-Up Sequence section should be followed after a reset or change in M.

A software reset (writing a 1 into Bit 5 of Register 0x00) is functionally equivalent to the hardware reset but does not force Register 0x00 to its default value.

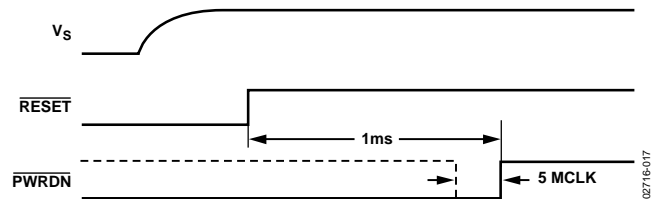

Figure 17. Power-Up Sequence for Tx Data Path

Transmit Power-Down

A low level on the $\overline{\text{PWRDN}}$ pin stops all clocks linked to the digital transmit data path and resets the CIC filter. Deasserting $\overline{\text{PWRDN}}$ reactivates all clocks. The CIC filter is held in a reset state for 80 MCLK cycles after the rising edge of $\overline{\text{PWRDN}}$ to allow for flushing of the half-band filters with new input data.

Transmit data bursts should be padded with at least 20 symbols of null data directly before the $\overline{\text{PWRDN}}$ pin is asserted.

Immediately after the $\overline{\text{PWRDN}}$ pin is deasserted, the transmit burst should start with a minimum of 20 null data symbols. This avoids unintended DAC output samples caused by the transmit path latency and filter settling time.

Software Power-Down Digital Tx (Bit 5 in Register 0x02) is functionally equivalent to the hardware $\overline{\text{PWRDN}}$ pin and takes effect immediately after the last register bit has been written over the serial port.

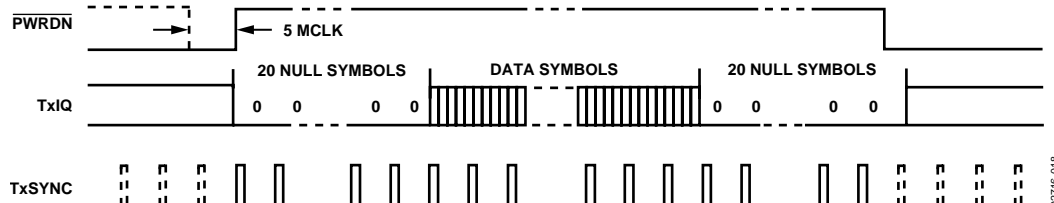

Figure 18. Timing Sequence to Flush Tx Data Path

Σ-Δ OUTPUTS

The AD9877 contains two independent Σ-Δ outputs that provide a digital logic bit stream with an average duty cycle that varies between 0% and (4095/4096)%, depending on the programmed code, as shown in Figure 19.

These bit streams can be low-pass filtered to generate programmable dc voltages of

$$V_{DC} = (\Sigma\text{-}\Delta \text{ Code}/4096)(V_H) + V_L$$

where:

$$V_H = V_{DRVDD} - 0.6 \text{ V.}$$

$$V_L = 0.4 \text{ V.}$$

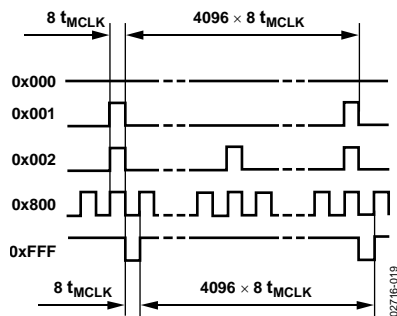

Figure 19. Σ-Δ Output Signals

In set-top box and cable modem applications, the outputs can be used to control external variable gain amplifiers and RF tuners. A simple single-pole RC low-pass filter provides sufficient filtering (Figure 20).

In more demanding applications where additional gain, level shift, or drive capability is required, a first or second order active filter might be considered for each Σ-Δ output (Figure 21).

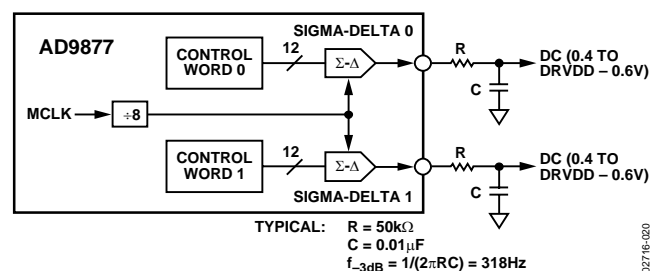

Figure 20. Σ-Δ RC Filter

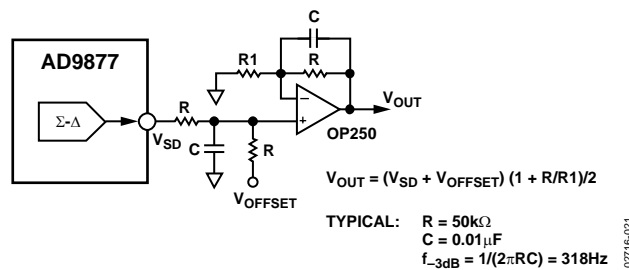

Figure 21. Σ-Δ Active Filter with Gain and Offset



REGISTER MAP AND BIT DEFINITIONS

Table 4. Register Map¹

Address (Hex)	Bit 7	Bit 6	Bit 5	Bit 4	Bit 3	Bit 2	Bit 1	Bit 0	Default (Hex)	Type
0x00	SDIO Bidirectional	LSB First	RESET	OSCIN Multiplier M [4]					08	Read/write
0x01	PLL Lock Detect	SYCLK Divider N = 3 (N = 4 Default)	MCLK Divider R [5:0]					00	Read/write	
0x02	Power-Down PLL	Power-Down DAC Tx	Power-Down Digital Tx	Power-Down 12-Bit ADC	Power-Down 12-Bit ADC Reference	0	0	Power-Down 8-Bit ADC	00	Read/write
0x03	Σ-Δ Output [0] Control Word [3:0] LSB				0	0	0	Flag [0] Enable	00	Read/write Σ-Δ
0x04	Flag [0]	Σ-Δ Output 0 Control Word [11:4] MSB							00	Read/write Σ-Δ
0x05	Σ-Δ Output [0] Control Word [3:0] LSB				0	0	0	Flag [1] Enable	00	Read/write Σ-Δ
0x06	Flag [1]	Σ-Δ Output 1 Control Word [11:4] MSB							00	Read/write Σ-Δ
0x07	0	0	0	0	0	0	0	0	00	Read/write Tx
0x08	ADC Clock Select	0	0	Power-Down RxSYNC and 8-Bit ADC Clock	0	0	0	0	80	Read/write ADC
0x09	0	0	0	0	0	0	0	0	00	Read/write
0x0A	0	0	0	0	0	0	0	0	00	Read only
0x0B	0	0	0	0	0	0	0	0	00	Read/write
0x0C	0	0	0	1	Version [3:0]				10	Read only
0x0D	Tx Frequency Tuning Word Profile 3 LSBs [1:0]		Tx Frequency Tuning Word Profile 2 LSBs [1:0]		Tx Frequency Tuning Word Profile 1 LSB [1:0]		Tx Frequency Tuning Word Profile 3 LSBs [1:0]		00	Read/write Tx
0x0E	0	0	0	0	DAC Gain Control [3:0]				00	Read/write Tx
0x0F	0	0	Profile Select [1:0]		CA Interface Mode Select	0	Spectral Inversion Tx	Single-Tone Tx Mode	00	Read/write Tx
0x10	Tx Frequency Turning Word Profile 0 [9:2]								00	Read/write Tx
0x11	Tx Frequency Turning Word Profile 0 [17:10]								00	Read/write Tx
0x12	Tx Frequency Turning Word Profile 0 [25:18]								00	Read/write Tx
0x13	CA Interface Transmit Word Control Profile 0 [7:4]				DAC Gain Control Profile 0 [3:0]				00	Read/write Tx
0x14	Tx Frequency Turning Word Profile 1 [9:2]								00	Read/write Tx
0x15	Tx Frequency Turning Word Profile 1 [9:2]								00	Read/write Tx
0x16	Tx Frequency Turning Word Profile 1 [9:2]								00	Read/write Tx
0x17	CA Interface Transmit Word Control Profile 1 [7:4]				DAC Gain Control Profile 1 [3:0]				00	Read/write Tx
0x18	Tx Frequency Turning Word Profile 2 [9:2]								00	Read/write Tx
0x19	Tx Frequency Turning Word Profile 2 [9:2]								00	Read/write Tx
1A	Tx Frequency Turning Word Profile 2 [9:2]								00	Read/write Tx
0x1B	CA Interface Transmit Word Control Profile 2 [7:4]				DAC Gain Control Profile 2 [3:0]				00	Read/write Tx
0x1C	Tx Frequency Turning Word Profile 3 [9:2]								00	Read/write Tx
0x1D	Tx Frequency Turning Word Profile 3 [9:2]								00	Read/write Tx
0x1E	Tx Frequency Turning Word Profile 3 [9:2]								00	Read/write Tx
0x1F	CA Interface Transmit Word Control Profile 3 [7:4]				DAC Gain Control Profile 3 [3:0]				00	Read/write Tx

¹ Register bits denoted with 0 must be programmed with a 0 each time that register is written.

REGISTER 0x00—INITIALIZATION

Bits 0–4: OSCIN Multiplier

This register field is used to program the on-chip multiplier (PLL) that generates the chip's high frequency system clock f_{SYSCLK} .

To multiply the external crystal clock f_{OSCIN} by 16 decimals, for example, program Register 0x00, Bits 4:0 as 0x10. The default value of M is 0x08. Valid entries range from $M = 1$ to 31. When M equals 1, the PLL is disabled. All internal clocks are derived directly from OSCIN.

The PLL requires 200 MCLK cycles to regain frequency lock after a change in M, the clock multiplier value. After the recapture time of the PLL, the frequency of f_{SYSCLK} is stable.

For timing integrity, certain restrictions on the values of M and N apply when both AD9877 transmit and receive paths are used. The supported modes are shown in Table 5.

Table 5. ADC Clock Select

ADC Clock Select	N	M
1, f_{OSCIN}	3	6
	4	8
0, f_{MCLK} (PLL derived)	3	12
	4	16

Bit 5: $\overline{\text{RESET}}$

Writing a 1 to this bit resets the registers to their default values and restarts the chip. The $\overline{\text{RESET}}$ bit always reads back 0. The bits in Register 0x00 are not affected by this software reset. A low level at the $\overline{\text{RESET}}$ pin, however, would force all registers, including all bits in Register 0x00, to their default state.

Bit 6: LSB First

Active high indicates SPI serial port access of instruction byte and data registers are least significant bit (LSB) first. Default low indicates most significant bit (MSB) first format.

Bit 7: SDIO Bidirectional

Active high configures the serial port as a three-signal port with the SDIO pin used as a bidirectional input/output pin. Default low indicates the serial port uses four signals with SDIO configured as an input and SDO configured as an output.

REGISTER 0x01—CLOCK CONFIGURATION

Bits 0–5: MCLK Divider

This register determines the output clock on the REFCLK pin. At default zero ($R = 0$), REFCLK provides a buffered version of the OSCIN clock signal for other chips.

The register can also be used to divide the chip's master clock, f_{MCLK} , by R, where R is an integer between 2 and 63. The generated reference clock on the REFCLK pin can be used for external frequency controlled devices.

Bit 6: SYSCLK Divider

The OSCIN multiplier output clock, f_{SYSCLK} , can be divided by 4 or 3 to generate the chip's master clock. Active high indicates a divide ratio of $N = 3$. Default low configures a divide ratio of $N = 4$.

Bit 7: PLL Lock Detect

When this bit is set low, the REFCLK pin functions in its default mode and provides an output clock with frequency $f_{\text{MCLK/R}}$, as described previously.

If this bit is set to 1, the REFCLK pin is configured to indicate whether the PLL is locked to f_{OSCIN} . In this mode, the REFCLK pin should be low-pass filtered with an RC filter of 1.0 k Ω and 0.1 μF . A high output on REFCLK indicates the PLL has achieved lock with f_{OSCIN} .

REGISTER 0x02—POWER-DOWN

Sections of the chip that are not used can be powered down when the corresponding bits are set high. This register has a default value of 0x00, with all sections active.

Bit 0: Power-Down 8-Bit ADC

Active high powers down the 8-bit ADC.

Bit 3: Power-Down 12-Bit ADC Reference

Active high powers down the 12-bit ADC reference.

Bit 4: Power-Down 12-Bit ADC

Active high powers down the 12-bit ADC.

Bit 5: Power-Down Digital Tx

Active high powers down the digital transmit section of the chip, similar to the function of the $\overline{\text{PWRDN}}$ pin.

Bit 6: Power-Down DAC Tx

Active high powers down the DAC.

Bit 7: Power-Down PLL

Active high powers down the OSCIN multiplier.

REGISTER 0x03–0x06— Σ - Δ CONTROL WORDS

The Σ - Δ control words are 12 bits wide and split into MSB Bits [11:4] and LSB Bits [3:0]. Changes to the Σ - Δ control words take effect immediately for every MSB or LSB register write. Σ - Δ output control words have a default value of 0. The control words are in straight binary format, with 0x000 corresponding to the bottom of the scale and 0xFFF corresponding to the top of the scale (see Figure 19 for details).

If flag enable (Bit 0 of Register 0x03 or 0x05) is set high, the SDELTA pins maintains a fixed logic level determined directly by the MSB of the Σ - Δ control word.

REGISTER 0x08—ADC CLOCK CONFIGURATION

Bit 4: Power-Down RxSYNC and 8-Bit ADC Clock

Setting this bit to 1 powers down the sampling clock of the 8-bit ADC and stops the RxSYNC output pin. It can be used for additional power saving on top of the power-down selections in Register 0x02.

Bit 7: ADC Clock Select

When set high, the input clock at OSCIN is used directly as the ADC sampling clock. When set low, the internally generated master clock, MCLK, is used as the ADC sampling clock. Best ADC performance is achieved when the ADCs are sampled directly from f_{OSCIN} using an external crystal or low jitter crystal oscillator.

REGISTER 0x0C—DIE REVISION

Bits 0–3: Version

The die version of the chip can be read from this register.

REGISTER 0x0D—Tx FREQUENCY TUNING WORDS LSBs

This register accommodates 2 LSBs for each of the four frequency tuning words (see the Registers 0x10–0x1F—Burst Parameter section).

REGISTER 0x0E—DAC GAIN CONTROL

This register allows the user to program the DAC gain if Tx Gain Control Select Bit 3 in Register 0x0F is set to 0.

Table 6. DAC Gain Control

Bits [3:0]	DAC Gain
0000	0.0 dB (default)
0001	0.5 dB
0010	1.0 dB
0011	1.5 dB
...	...
1110	7.0 dB
1111	7.5 dB

REGISTER 0x0F—Tx PATH CONFIGURATION

Bit 0: Single-Tone Tx Mode

Active high configures the AD9877 for single-tone applications such as FSK. The AD9877 will supply a single-frequency output as determined by the frequency tuning word selected by the active profile. In this mode, the TxIQ input data pins are ignored but should be tied to a valid logic voltage level. Default value is 0 (inactive).

Bit 1: Spectral Inversion Tx

When set to 1, inverted modulation is performed.

$$MODULATOR_OUT = [I \cos(\omega t) + Q \sin(\omega t)]$$

Default is logic low, noninverted modulation.

$$MODULATOR_OUT = [I \cos(\omega t) - Q \sin(\omega t)]$$

Bit 3: CA Interface Mode Select

This bit changes the manner in which transmit gain control is performed. Typically, either AD8321/AD8325 (Default 0) or AD8322/AD8327 (Default 1) variable gain cable amplifiers are programmed over the chip's 3-wire cable amplifier (CA) interface. The Tx gain control select changes the interpretation of the bits in Registers 0x13, 0x17, 0x1B, and 0x1F (see the Cable Driver Gain Control section).

Bits 4–5: Profile Select

The AD9877 quadrature digital upconverter is capable of storing four preconfigured modulation modes called profiles. Each profile defines a transmit frequency tuning word and cable driver amplifier gain (DAC gain) setting. Profile Select [1:0] bits or PROFILE [1:0] pins program the current register profile to be used. Profile Select bits should always be 0 if PROFILE[1:0] pins are used to switch between profiles. Using the Profile Select bits as a means of switching between different profiles requires the PROFILE [1:0] pins to be tied low.

REGISTERS 0x10–0x1F—BURST PARAMETER

Tx Frequency Tuning Words

The frequency tuning word (FTW) determines the DDS-generated carrier frequency (f_c) and is formed via a concatenation of register addresses.

The 26-bit FTW is spread over four register addresses. Bit 25 is the MSB, and Bit 0 is the LSB.

The carrier frequency equation is given as

$$f_c = [FTW \times f_{SYSCLK}] / 2^{26}$$

where:

$$f_{SYSCLK} = M \times f_{OSCIN} \\ FTW < 0 \times 2000000.$$

Changes to FTW bytes take effect immediately.

Cable Driver Gain Control

The AD9877 has a three-pin interface to the AD832x family of programmable gain cable driver amplifiers. This allows direct control of the cable driver's gain through the AD9877.

In its default mode, the complete 8-bit register value is transmitted over the 3-wire CA interface.

If Bit 3 of Register 0x0F is set high, Bits [7:4] determine the 8-bit word sent over the CA interface according to Table 7.

Table 7. Cable Driver Gain Control

Bits [7:4]	CA Interface Transmit Word
0000	0000 0000 (default)
0001	0000 0001
0010	0000 0010
0011	0000 0100
0100	0000 1000
0101	0001 0000
0110	0010 0000
0111	0100 0000
1000	1000 0000

In this mode, the lower bits determine the fine gain setting of the DAC output.

Table 8. DAC Output Fine Gain Setting

Bits [3:0]	DAC Fine Gain
0000	0.0 dB (default)
0001	0.5 dB
0010	1.0 dB
0011	1.5 dB
...	...
1110	7.0 dB
1111	7.5 dB

New data is automatically sent over the 3-wire CA interface (and DAC gain adjust) whenever the value of the active gain control register changes or a new profile is selected. The default value is 0x00 (lowest gain).

The formula for the combined output level calculation of the AD9877 fine gain and the AD8327 or AD8322 coarse gain is

$$V_{8327} = V_{9877(0)} + (fine)/2 + 6(coarse) - 19$$

$$V_{8322} = V_{9877(0)} + (fine)/2 + 6(coarse) - 14$$

where:

fine is the decimal value of Bits [3:0].

coarse is the decimal value of Bits [7:8].

$V_{9877(0)}$ is the level at AD9877 output in dBmV for *fine* = 0.

V_{8327} is the level at output of the AD8327 in dBmV.

V_{8322} is the level at output of the AD8322 in dBmV.

SERIAL INTERFACE FOR REGISTER CONTROL

The AD9877 serial port is a flexible, synchronous serial communication port allowing easy interface to many industry-standard microcontrollers and microprocessors. The interface allows read/write access to all registers that configure the AD9877. Single or multiple byte transfers are supported. Also, the interface can be programmed to read words either MSB first or LSB first. The serial interface port I/O of the AD9877 can be configured to have one bidirectional I/O (SDIO) pin or two unidirectional I/O (SDIO/SDO) pins.

GENERAL OPERATION OF THE SERIAL INTERFACE

There are two phases to a communication cycle with the AD9877. Phase 1 is the instruction cycle, which is the writing of an instruction byte into the AD9877 that is coincident with the first eight SCLK rising edges. The instruction byte provides the AD9877 serial port controller with information regarding the data transfer cycle, Phase 2 of the communication cycle. The Phase 1 instruction byte defines whether the upcoming data transfer is a read or write, the number of bytes in the data transfer, and the starting register address for the first byte of the data transfer. The first eight SCLK rising edges of each communication cycle are used to write the instruction byte into the AD9877.

The eight remaining SCLK edges are for Phase 2 of the communication cycle. Phase 2 is the actual data transfer between the AD9877 and the system controller. Phase 2 of the communication cycle is a transfer of 1 to 4 data bytes as determined by the instruction byte. Registers change immediately upon writing to the last bit of each transfer byte.

INSTRUCTION BYTE

Table 9 illustrates the information contained in the instruction byte.

Table 9. Instruction Byte Information

MSB				LSB			
I7	I6	I5	I4	I3	I2	I1	I0
R/W	N1	N0	A4	A3	A2	A1	A0

The R/W bit of the instruction byte determines whether a read or a write data transfer will occur after the instruction byte write. Logic high indicates a read operation. Logic low indicates a write operation. The N1:N0 bits determine the number of bytes to be transferred during the data transfer cycle. The bit decodes are shown in Table 10.

Table 10. Bit Decodes

N1	N0	Description
0	0	Transfer 1 byte
0	1	Transfer 2 bytes
1	0	Transfer 3 bytes
1	1	Transfer 4 bytes

The Bits A4:A0 determine which register is accessed during the data transfer portion of the communication cycle. For multibyte transfers, this address is the starting byte address. The remaining register addresses are generated by the AD9877.

SERIAL INTERFACE PORT PIN DESCRIPTION

SCLK—Serial Clock

The serial clock pin is used to synchronize data transfers from the AD9877 and to run the serial port state machine. The maximum SCLK frequency is 15 MHz. Input data to the AD9877 is sampled upon the rising edge of SCLK. Output data changes upon the falling edge of SCLK.

\overline{CS} —Chip Select

Active low input starts and gates a communication cycle. It allows multiple devices to share a common serial port bus. The SDO and SDIO pins go to a high impedance state when \overline{CS} is high. Chip select should stay low during the entire communication cycle.

SDIO—Serial Data I/O

Data is always written into the AD9877 on this pin. However, this pin can be used as a bidirectional data line. The configuration of this pin is controlled by Bit 7 of Register 0x00. The default is Logic 0, which configures the SDIO pin as unidirectional.

SDO—Serial Data Out

Data is read from this pin for protocols that use separate lines for transmitting and receiving data. When the AD9877 operates in a single bidirectional I/O mode, this pin does not output data and is set to a high impedance state.

MSB/LSB TRANSFERS

The AD9877 serial port can support both the MSB-first or the least significant bit LSB-first data formats. This functionality is controlled by the LSB-first bit in Register 0x00. The default is MSB first.

When this bit is set active high, the AD9877 serial port is in LSB-first format. In LSB-first mode, the instruction byte and data bytes must be written from the LSB to the MSB. In MSB-first mode, the serial port internal byte address generator increments for each byte of the multibyte communication cycle.

When this bit is set default low, the AD9877 serial port is in MSB-first format. In MSB-first mode, the instruction byte and data bytes must be written from the MSB to the LSB. In MSB-first mode, the serial port internal byte address generator decrements for each byte of the multibyte communication cycle.

When incrementing from 0x1F, the address generator changes to 0x00. When decrementing from 0x00, the address generator changes to 0x1F.

NOTES ON SERIAL PORT OPERATION

The AD9877 serial port configuration bits reside in Bit 6 and Bit 7 of Register 0x00. It is important to note that the configuration changes immediately upon writing to the last bit of the register. For multibyte transfers, writing to this register may occur during the middle of the communication cycle.

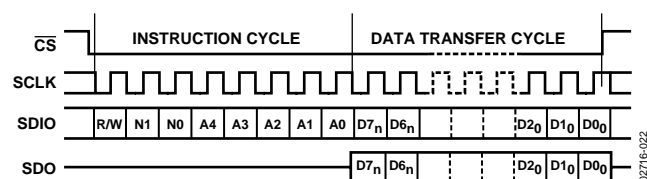

Figure 22. Serial Register Interface Timing MSB First

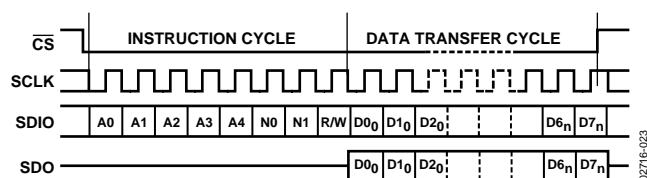

Figure 23. Serial Register Interface Timing LSB First

Care must be taken to compensate for this new configuration for the remaining bytes of the current communication cycle. The same considerations apply to setting the $\overline{\text{RESET}}$ bit in Register 0x00. All other registers are set to their default values, but the software reset does not affect the bits in Register 0x00. It is recommended to use only single-byte transfers when changing serial port configurations or initiating a software reset.

A write to Bits 1, 2, and 3 of Register 0x00 with the same logic levels as Bits 7, 6, and 5 (bit pattern: XY1001YX binary) allows the host processor to reprogram a lost serial port configuration and to reset the registers to their default values. A second write to Register 0x00 with $\overline{\text{RESET}}$ bit low and serial port configuration as specified above (XY) reprograms the OSCIN multiplier setting. A changed f_{SYSCLK} frequency is stable after a maximum of 200 f_{MCLK} cycles.

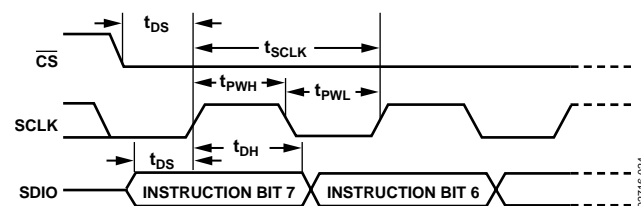

Figure 24. Timing Diagram for Register Write to AD9877

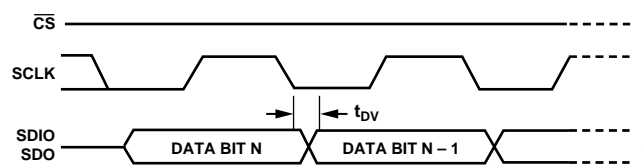

Figure 25. Timing Diagram for Register Read from AD9877

TRANSMIT PATH (Tx)

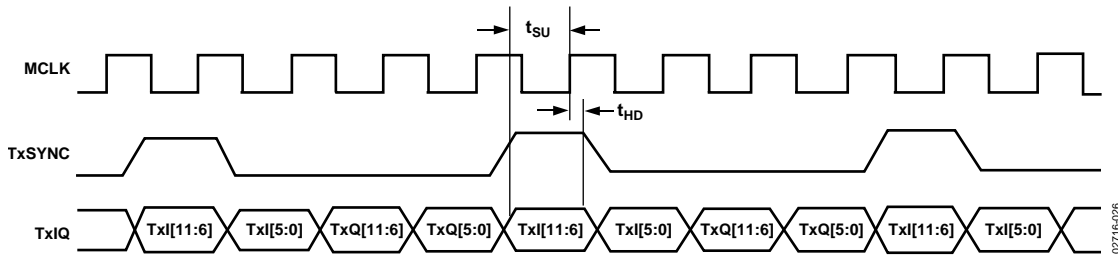

Figure 26. Transmit Timing Diagram

TRANSMIT TIMING

The AD9877 provides a master clock, MCLK, and expects 6-bit multiplexed TxIQ data upon each rising edge. Transmit symbols are framed with the TxSYNC input. TxSYNC high indicates the start of a transmit symbol. Four consecutive 6-bit data packages form a symbol (I MSB, I LSB, Q MSB, and Q LSB).

DATA ASSEMBLER

The input data stream is representative complex data. Two 6-bit words form a 12-bit symbol component (twos complement format). Four input samples are required to produce one I/Q data pair. The I/Q sample rate, f_{IQCLK} , at the input to the first half-band filter is a quarter of the input data rate, f_{MCLK} .

The I/Q sample rate, f_{IQCLK} , puts a bandwidth limit on the maximum transmit spectrum. This is the familiar Nyquist limit and is equal to one-half f_{IQCLK} , hereafter referred to as f_{NYQ} .

HALF-BAND FILTERS (HBFs)

HBF 1 and HBF 2 are both interpolating filters, each of which doubles the sampling rate. Together, HBF 1 and HBF 2 have 26 taps and provide a factor of 4 increase in the sampling rate ($4 \times f_{IQCLK}$ or $8 \times f_{NYQ}$).

In relation to phase response, both HBFs are linear phase filters. As such, virtually no phase distortion is introduced within the pass band of the filters. This is an important feature, because phase distortion is generally intolerable in a data transmission system.

CASCADED INTEGRATOR-COMB (CIC) FILTER

A CIC filter is unlike a typical FIR filter in that it offers the flexibility to handle differing input and output sample rates in any integer ratios. In the AD9877, the CIC filter is configured as a programmable interpolator and provides a sample rate increase by a factor of $R = 3$ or $R = 4$. In addition to the ability to provide a change in the sample rate between the input and output, a CIC filter has an intrinsic low-pass frequency response characteristic.

The frequency response of a CIC filter is dependent on three factors:

- The rate change ratio, R .
- The order of the filter, n .
- The number of unit delays per stage, m .

It can be shown that the system function $H(z)$ of a CIC filter is given by

$$Hz = \left(\left(\frac{1}{R} \right) \frac{1 - z^{-Rm}}{1 - z^{-1}} \right)^n = \left(\left(\frac{1}{R} \right) \sum_{k=0}^{Rm-1} z^{-k} \right)^n$$

The form on the far right has the advantage of providing a result for $z = 1$ (corresponding to zero frequency or dc). The alternate form yields an indeterminate form (0/0) for $z = 1$, but is otherwise identical. The only variable parameter for the CIC filter of the AD9877 is R ; m and n are fixed at 1 and 3, respectively. Thus, the CIC system function for the AD9877 simplifies to

$$Hz = \left(\left(\frac{1}{R} \right) \frac{1 - z^{-R}}{1 - z^{-1}} \right)^3 = \left(\left(\frac{1}{R} \right) \sum_{k=0}^{R-1} z^{-k} \right)^3$$

The transfer function is given by

$$|H(f)| = \left| \left(\left(\frac{1}{R} \right) \frac{1 - e^{-j(2\pi/R)}}{1 - e^{-j(2\pi f)}} \right)^3 \right| = \left| \left(\left(\frac{1}{R} \right) \frac{\sin(\pi f R)}{\sin(\pi f)} \right)^3 \right|$$

The frequency response in this form is such that f is scaled to the output sample rate of the CIC filter. That is, $f = 1$ corresponds to the frequency of the output sample rate of the CIC filter. $H(z)$ yields the frequency response with respect to the input sample of the CIC filter.

COMBINED FILTER RESPONSE

The combined frequency response of HBF 1, HBF 2, and CIC is shown in Figure 27, Figure 28, Figure 29, Figure 31, Figure 32, and Figure 33.

The usable bandwidth of the filter chain puts a limit on the maximum data rate that can be propagated through the AD9877. A look at the pass-band detail of the combined filter response (Figure 30 and Figure 34) indicates that to maintain an amplitude error of no more than 1 dB, use signals having a bandwidth of no more than about 60% of f_{NYQ} .

To keep the bandwidth of the data in the flat portion of the filter pass band, the user must oversample the baseband data by at least a factor of 2 prior to representing it to the AD9877. Without oversampling, the Nyquist bandwidth of the baseband data corresponds to the f_{NYQ} . Consequently, the upper end of the data bandwidth suffers 6 dB or more of attenuation due to the frequency response of the digital filters.

There is an additional concern if the baseband data applied to the AD9877 has been pulse shaped. Typically, pulse shaping is applied to the baseband data via a filter having a raised cosine response.

In such cases, an α value is used to modify the bandwidth of the data where the value of α is such that $0 \leq \alpha \leq 1$. A value of 0 causes the data bandwidth to correspond to the Nyquist bandwidth. A value of 1 causes the data bandwidth to be extended to twice the Nyquist bandwidth.

Thus, with $2\times$ oversampling of the baseband data and $\alpha = 1$, the Nyquist bandwidth of the data corresponds with the I/Q Nyquist bandwidth. As stated earlier, this results in problems near the upper edge of the data bandwidth due to the frequency response of the filters. The maximum value of α that can be implemented is 0.45. This is because the data bandwidth becomes

$$\frac{1}{2}(1 + \alpha)f_{NYQ} = 0.725 f_{NYQ}$$

which puts the data bandwidth at the extreme edge of the flat portion of the filter response.

If a particular application requires an α value between 0.45 and 1, the user must oversample the baseband data by at least a factor of 4. The combined HBF1, HBF2, and CIC filter introduces a worst-case droop of less than 0.2 dB over the frequency range of the data to be transmitted.

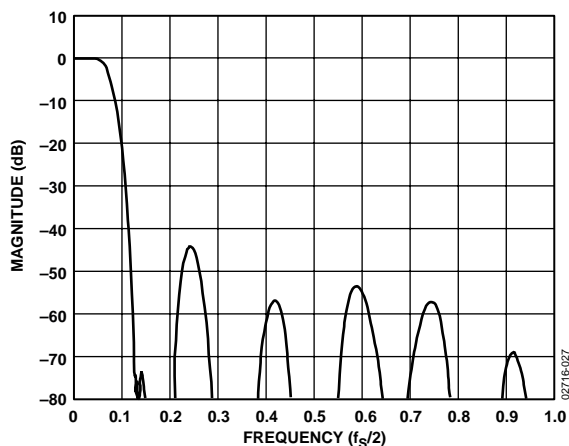

Figure 27. Cascaded Filter 12x Interpolator ($N = 3$)

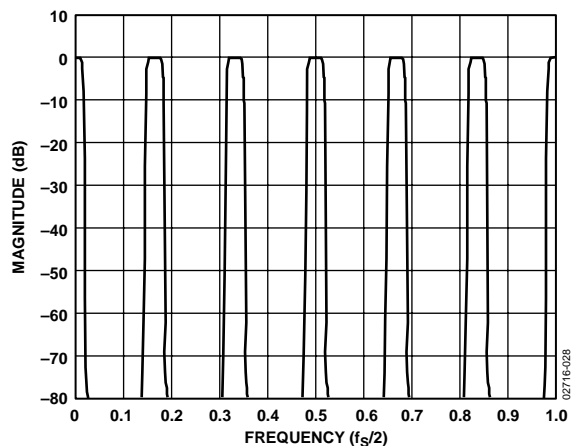

Figure 28. Input Signal Spectrum ($N = 3$), $\alpha = 0.25$

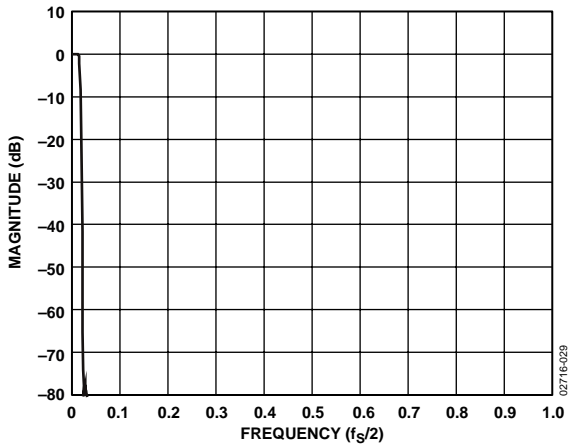

Figure 29. Response to Input Signal Spectrum (N = 3)

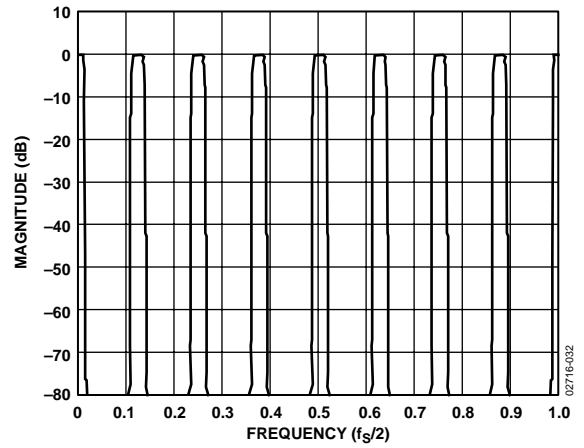

Figure 32. Input Signal Spectrum (N = 4), $\alpha = 0.25$

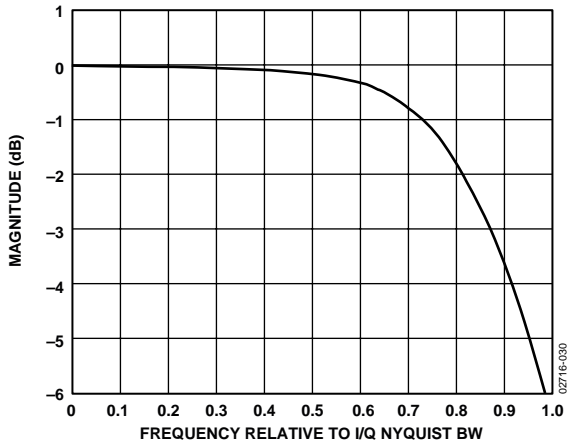

Figure 30. Cascaded Filter Pass-Band Detail (N = 3)

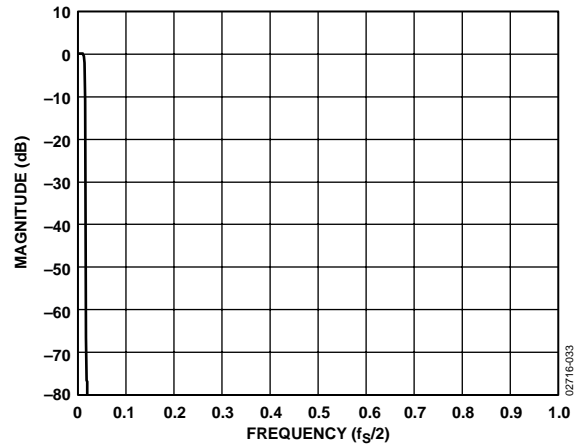

Figure 33. Response to Input Signal Spectrum (N = 4)

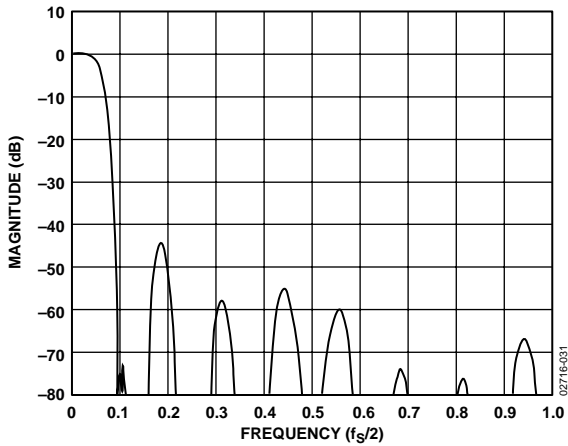

Figure 31. Cascaded Filter 16x Interpolator (N = 4)

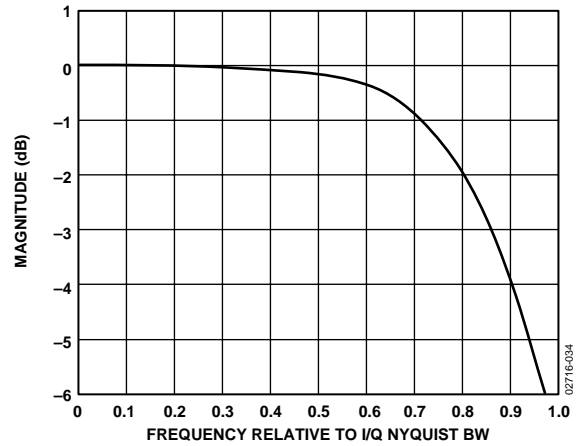

Figure 34. Cascaded Filter Pass-Band Detail (N = 4)

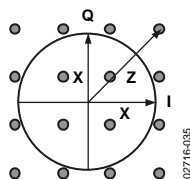

Figure 35. 16-Quadrature Modulation

Tx SIGNAL LEVEL CONSIDERATIONS

The quadrature modulator introduces a maximum gain of 3 dB in the signal level. To visualize this, assume that both the I data and Q data are fixed at the maximum possible digital value, x . Then the output of the modulator, z , is

$$z = [x \cos(\omega t) - x \sin(\omega t)]$$

It can be shown that $|z|$ assumes a maximum value of

$$|z| = \sqrt{(x^2 + x^2)} = x\sqrt{2} \text{ (a gain of +3 dB)}$$

However, if the same number of bits are used to represent the $|z|$ values as is used to represent the x values, an overflow occurs. To prevent this possibility, an effective -3 dB attenuation is internally implemented on the I and Q data path.

$$(|z| = \sqrt{(1/2 + 1/2)} = x)$$

The following example assumes a Pk/rms level of 10 dB:

$$\text{Maximum Symbol Component Input Value} = \pm(2,047 \text{ LSBs} - 0.2 \text{ dB}) = \pm 2,000 \text{ LSBs}$$

$$\text{Maximum Complex Input RMS Value} = 2,000 \text{ LSBs} + 6 \text{ dB} - Pk/rms \text{ (dB)} = 1,265 \text{ LSBs rms}$$

Maximum complex input rms value calculation uses both I and Q symbol components, which adds a factor of 2 (6 dB) to the formula.

Table 11 shows typical IQ input test signals with amplitude levels related to 12-bit full scale (FS).

Table 11. IQ Input Test Signals

Analog Output	Digital Input	Input Level	Modulator Output Level
Single Tone ($f_c - f$)	$I = \cos(f)$ $Q = \cos(f + 90^\circ) = -\sin(f)$	FS - 0.2 dB FS - 0.2 dB	FS - 3.0 dB
Single Tone ($f_c + f$)	$I = \cos(f)$ $Q = \cos(f + 270^\circ) = +\sin(f)$	FS - 0.2 dB FS - 0.2 dB	FS - 3.0 dB
Dual Tone ($f_c \pm f$)	$I = \cos(f)$ $Q = \cos(f + 180^\circ) = -\cos(f)$ or $Q = +\cos(f)$	FS - 0.2 dB FS - 0.2 dB	FS

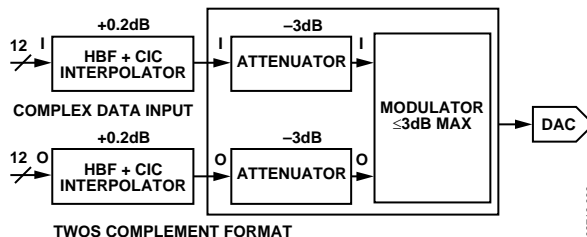

Figure 36. Signal Level Contribution

Tx THROUGHPUT AND LATENCY

Data inputs impact the output fairly quickly but remain effective due to the filter characteristics of the AD9877. Data transmit latency through the AD9877 is easiest to describe in terms of f_{SYSCLK} clock cycles ($4 f_{MCLK}$). The numbers quoted are when an effect is first seen after an input value changes.

Latency of I/Q data entering the data assembler (AD9877 input) to the DAC output is $119 f_{SYSCLK}$ clock cycles ($29.75 f_{MCLK}$ cycles). DC values applied to the data assembler input take up to $176 f_{SYSCLK}$ clock cycles ($44 f_{MCLK}$ cycles) to propagate and settle at the DAC output.

Frequency hopping is accomplished via changing the PROFILE input pins. The time required to switch from one frequency to another is less than $232 f_{SYSCLK}$ cycles ($58.5 f_{MCLK}$ cycles).

DIGITAL-TO-ANALOG CONVERTER

A 12-bit digital-to-analog converter (DAC) is used to convert the digitally processed waveform into an analog signal. The worst-case spurious signals due to the DAC are the harmonics of the fundamental signal and their aliases. The conversion process produces aliased components of the fundamental signal at $n \times f_{SYSCLK} \pm f_{CARRIER}$ ($n = 1, 2, \text{ and } 3$). These are typically filtered with an external RLC filter at the DAC output.

It is important for this analog filter to have a sufficiently flat gain and linear phase response across the bandwidth of interest to avoid modulation impairments. A relatively inexpensive seventh-order elliptical low-pass filter is sufficient to suppress the aliased components for HFC network applications.

AD9877

The AD9877 provides true and complement current outputs. The full-scale output current is set by the R_{SET} resistor at Pin 49 and the DAC gain register. Assuming maximum DAC gain, the value of R_{SET} for a particular full-scale I_{OUT} is determined using the following equation:

$$R_{SET} = 32 V_{DACRSET}/I_{OUT} = 39.4/I_{OUT}$$

For example, if a full-scale output current of 20 mA is desired, then $R_{SET} = (39.4/0.02) \Omega$ or approximately 2 k Ω .

The following equation calculates the full-scale output current, including the programmable DAC gain control.

$$I_{OUT} = [39.4/R_{SET}] \times 10^{(-7.5 + 0.5 N_{GAIN})/20}$$

where N_{GAIN} is the value of DAC fine gain control [3:0].

The full-scale output current range of the AD9877 is 4 to 20 mA. Full-scale output currents outside of this range degrade SFDR performance. SFDR is also slightly affected by output matching; the two outputs should be terminated equally for best SFDR performance. The output load should be located as close as possible to the AD9877 package to minimize stray capacitance and inductance. The load can be a simple resistor to ground, an op amp current-to-voltage converter, or a transformer-coupled circuit. It is best not to attempt to directly drive highly reactive loads (such as an LC filter). Driving an LC filter without a transformer requires that the filter be doubly terminated for best performance.

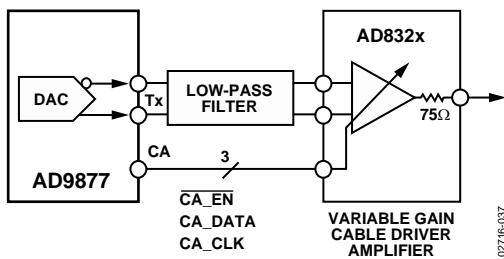

Figure 37. Cable Amplifier Connection

The filter input and output should both be resistively terminated with the appropriate values. The parallel combination of the two terminations will determine the load that the AD9877 will see for signals within the filter pass band.

For example, a 50 Ω terminated input/output low-pass filter will look like a 25 Ω load to the AD9877. The output compliance voltage of the AD9877 is -0.5 V to $+1.5$ V. To avoid signal distortion, any signal developed at the DAC output should not exceed 1.5 V. Furthermore, the signal may extend below ground as much as 0.5 V without damage or signal distortion.

The AD9877 true and complement outputs can be differentially combined for common-mode rejection using a broadband 1:1 transformer. Using a grounded center tap results in signals at the AD9877 DAC output pins that are symmetrical about ground. As previously mentioned, by differentially combining the two signals, the user can provide some degree of common-mode signal rejection. A differential combiner might consist of a transformer or an operational amplifier. The object is to combine or amplify only the difference between two signals and to reject any common, usually undesirable characteristic, such as 60 Hz hum or clock feedthrough that is equally present on both individual signals.

Connecting the AD9877 true and complement outputs to the differential inputs of the gain programmable cable drivers AD8321/AD8323 or AD8322/AD8327 provides an optimized solution for the standard compliant cable modem upstream channel. The cable driver's gain can be programmed through a direct 3-wire interface using the profile registers of the AD9877.

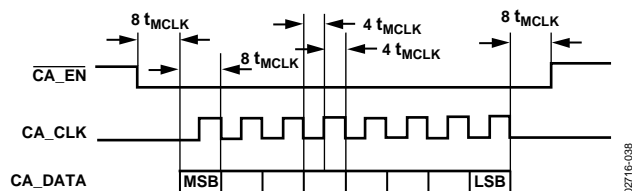

Figure 38. Cable Amplifier Interface Timing

PROGRAMMING THE AD8321/AD8325 OR AD8322/AD8327 CABLE DRIVER AMPLIFIER GAIN CONTROL

Programming the gain of the AD832x family cable driver amplifier can be accomplished via the AD9877 cable amplifier control interface. Four 8-bit registers within the AD9877 (one per profile) store the gain value to be written to the serial 3-wire port. Typically either AD8321/AD8325 or AD8322/AD8327 variable gain cable amplifiers are connected to the chip's 3-wire cable amplifier interface. The Tx gain control select bit in Register 0x0F changes the interpretation of the bits in Registers 0x13, 0x17, 0x1B, and 0x1F. See the Cable Driver Gain Control section register description.

Data transfers to the gain programmable cable driver amplifier are initiated by the following four conditions.

1. **Power-Up and Hardware Reset**—Upon initial power-up and every hardware reset, the AD9877 clears the contents of the gain control registers to 0, which defines the lowest gain setting of the AD832x. Thus, the AD9877 writes all 0s out of the 3-wire cable amplifier control interface.
2. **Software Reset**—Writing a 1 to Bit 5 of Address 0x00 initiates a software reset. Upon a software reset, the AD9877 clears the contents of the gain control registers to 0 for the lowest gain and sets the profile select to 0. The AD9877 writes all 0s out of the 3-wire cable amplifier control interface if the gain was previously on a different setting (other than 0).
3. **Change in Profile Selection**—The AD9877 samples the PROFILE(1) and PROFILE(2) input pins together with the two profile select bits and writes to the AD832x gain control registers if a change in profile and gain is determined. The data written to the cable driver amplifier comes from the AD9877 gain control register associated with the current profile.
4. **Write to AD9877 Cable Driver Amplifier Control Registers**—The AD9877 will write gain control data associated with the current profile to the AD832x whenever the selected AD9877 cable driver amplifier gain setting is changed.

Once a new stable gain value has been detected (48 MCLK to 64 MCLK cycles after initiation), a data write starts with CA_CS going low. The AD9877 always finishes a write sequence to the cable driver amplifier once it is started. The logic controlling data transfers to the cable driver amplifier uses up to 200 MCLK cycles and is designed to prevent erroneous write cycles from occurring.

RECEIVE PATH (Rx)

ADC THEORY OF OPERATION

The analog-to-digital converters of the AD9877 implement pipelined multistage architectures to achieve high sample rates while consuming low power. Each ADC distributes the conversion over several smaller ADC subblocks, refining the conversion with progressively higher accuracy as it passes the results from stage to stage.

As a consequence of the distributed conversion, ADCs require a small fraction of the 2^n comparators used in a traditional n-bit flash-type ADC. A sample-and-hold function within each of the stages permits the first stage to operate on a new input sample while the remaining stages operate on preceding samples. Each stage of the pipeline, excluding the last, consists of a low resolution flash ADC connected to a switched capacitor DAC and interstage residue amplifier (MDAC). The residue amplifier amplifies the difference between the reconstructed DAC output and the flash input for the next stage in the pipeline. One bit of redundancy is used in each stage to facilitate digital correction of flash errors. The last stage simply consists of a flash ADC.

The analog inputs of the AD9877 incorporate a novel structure that merges the input sample-and-hold amplifiers (SHA) and the first pipeline residue amplifiers into single, compact switched capacitor circuits. This structure achieves considerable noise and power savings over a conventional implementation that uses separate amplifiers by eliminating one amplifier in the pipeline. By matching the sampling network of the input SHA with the first stage flash ADC, the ADCs can sample inputs well beyond the Nyquist frequency with no degradation in performance.

The digital data outputs of the ADCs are represented in straight binary format. They saturate to full scale or zero scale when the input signal exceeds the input voltage range.

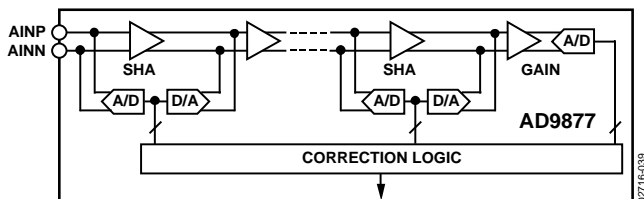

Figure 39. ADC Architecture

RECEIVE TIMING

The AD9877 sends multiplexed data to the RxIQ outputs upon every rising edge of MCLK. The data stream consists of two nibbles of I data followed by two nibbles of Q data. The RxSYNC pulse frames the I/Q data and is coincidentally high with the most significant nibble of the I data-word. If the 8-bit I/Q ADC is in power-down mode, the RxSYNC signal will not be generated.

The 12-bit ADC data is sent to the IF[11:0] outputs upon every second falling edge of MCLK.

In its default setting, the REFCLK pin provides a buffered version of f_{OSCIN} . REFCLK can be used as a qualifying clock for the Rx data when the ratio between the OSCIN multiplier and the OSCIN divider is programmed to be 2 ($M/N = 2$) or when the ADC sampling is selected to be derived from f_{OSCIN} directly.

DRIVING THE ANALOG INPUTS

Figure 40 illustrates the equivalent analog inputs of the AD9877 (a switched capacitor input). Bringing CLK to a logic high opens Switch S3 and closes Switches S1 and S2. The input source is connected to AIN and must charge capacitor C_H during this time. Bringing CLK to a logic low opens switch S2, and then Switch S1 opens followed by closing switch S3. This places the input into hold mode.

The structure of the input SHA places certain requirements on the input drive source. The combination of the pin capacitance and the hold capacitance of C_H is typically less than 5 pF. The input source must be able to charge or discharge this capacitance to its n-bit accuracy in one-half of a clock cycle. When the SHA goes into track mode, the input source must charge or discharge capacitor C_H from the voltage already stored on C_H to the new voltage. In the worst case, a full-scale voltage step on the input source must provide the charging current through the R_{ON} (100 Ω) of Switch S1 and quickly (within 1/2 CLK period) settle. This situation corresponds to driving a low input impedance.

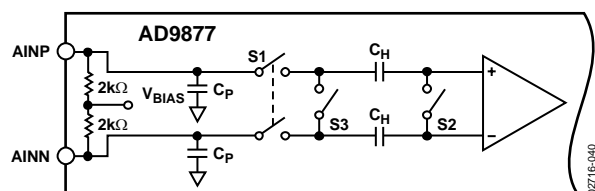

Figure 40. Differential Input Architecture

On the other hand, when the source voltage equals the value previously stored on C_H , the hold capacitor requires no input current and the equivalent input impedance is extremely high. Adding series resistance between the output of the signal source and the AIN pin reduces the drive requirements placed on the signal source. Figure 41 shows this configuration.

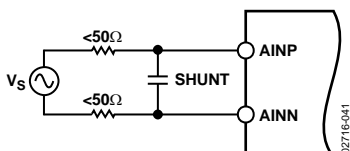

Figure 41. Simple ADC Drive Configuration

The bandwidth of the particular application limits the size of this resistor. To maintain the performance outlined in the data sheet specifications, the resistor should be limited to $50\ \Omega$ or less. For applications with signal bandwidths less than 10 MHz, the user can proportionally increase the size of the series resistor. Alternatively, adding a shunt capacitance between the AIN pins can lower the ac load impedance. The value of this capacitance will depend on the source resistance and the required signal bandwidth. In systems that must use dc-coupling, use an op amp to comply with the input requirements of the AD9877.

OP AMP SELECTION GUIDE

Op amp selection for the AD9877 is highly application dependent. In general, the performance requirements of any given application can be characterized by either time domain or frequency domain constraints. In either case, one should carefully select an op amp that preserves the performance of the ADC. This task becomes challenging when one considers the high performance capabilities of the AD9877 coupled with other system level requirements, such as power consumption and cost. The ability to select the optimal op amp can be further complicated by either limited power supply availability and/or limited acceptable supplies for a desired op amp.

Newer, high performance op amps typically have input and output range limitations in accordance with their lower supply voltages. As a result, some op amps will be more appropriate in systems where ac coupling is allowed. When dc coupling is required, op amp headroom constraints (such as rail-to-rail op amps), or instances where larger supplies can be used, should be considered.

Analog Devices offers differential output operational amplifiers, such as the AD8131, with a fixed gain of 2. They can be used for differential or single-ended-to-differential signal conditioning with 8-bit performance to directly drive ADC inputs. The AD8138 is a higher performance version of the AD8131. It provides 12-bit performance and allows different gain settings. Please contact the local sales office for updates on the latest Analog Devices amplifier product offerings.

ADC DIFFERENTIAL INPUTS

The AD9877 uses a 1 V p-p input span for the 8-bit ADC inputs and a 2 V p-p for the 12-bit ADC. Since not all applications have a signal preconditioned for differential operation, there is often a need to perform a single-ended-to-differential conversion. In systems that do not need a dc input, an RF transformer with a center tap is the best method to generate differential inputs beyond 20 MHz for the AD9877. This provides all the benefits of operating the ADC in the differential mode without contributing additional noise or distortion. An RF transformer also has the added benefit of providing electrical isolation between the signal source and the ADC. An improvement in THD and SFDR performance can be realized by operating the AD9877 in differential mode. The performance enhancement between the differential and single-ended mode is most considerable as the input frequency approaches and goes beyond the Nyquist frequency ($f_N > f_s/2$).

The AD8131 provides a convenient method of converting a single-ended signal to a differential signal. This is an ideal method for generating a signal directly coupled to the AD9877.

The AD8131 will accept a signal swinging below 0 V and shift it to an externally provided common-mode voltage. The AD8131 configuration is shown in Figure 42.

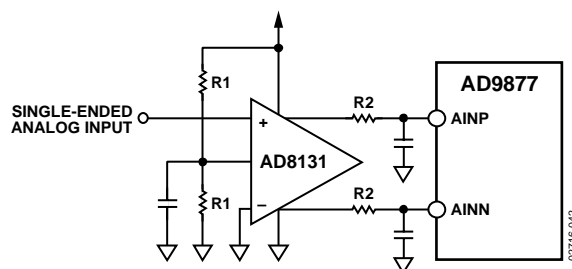

Figure 42. Single-Ended-to-Differential Input Drive

Figure 43 shows the schematic of a possible transformer coupled circuit. Transformers with turn ratios (n_2/n_1) other than 1 can be selected to optimize the performance of a given application. For example, selecting a transformer with a higher impedance ratio (such as minicircuits T16 to 6T with an impedance ratio of $(z_2/z_1) = 16 = (n_2/n_1)^2$) effectively steps up the signal amplitude, thus further reducing the output voltage swing of the signal source.

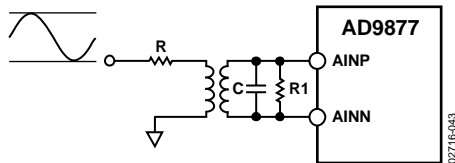

Figure 43. Transformer Coupled Input

In Figure 43, a resistor R1 is added between the analog inputs to match the source impedance R as in the formula

$$R = [R1 || R_{AIN}](Z_1/Z_2)$$

ADC VOLTAGE REFERENCES

The AD9877 has two independent internal references for its 8-bit and 12-bit ADCs. Both 8-bit ADCs have a 1 V p-p input and share one internal reference source. The 12-bit ADC, however, is designed for 2 V p-p input voltages and provides its own internal reference. Figure 16 shows the proper connections of the reference pins REFT and REFB.

External references may be necessary for systems that require high accuracy gain matching between ADCs or improvements in temperature drift and noise characteristics. External references REFT and REFB need to be centered at $AVDD/2$ with offset voltages as specified:

$$REFT8: AVDDI/2 + 0.25 \text{ V}$$

$$REFB8: AVDDI/2 - 0.25 \text{ V}$$

$$REFT12: AVDD/2 + 0.5 \text{ V}$$

$$REFB12: AVDD/2 - 0.5 \text{ V}$$

A differential level of 0.5 V between the reference pins results in a 1 V p-p ADC input level AIN. A differential level of 1 V between the reference pins results in a 2 V p-p ADC input level AIN. Internal reference sources can be powered down when external references are used (Register Address 0x002).

PCB DESIGN CONSIDERATIONS

Although the AD9877 is a mixed-signal device, it should be treated as an analog component. The on-chip digital circuitry is specially designed to minimize the impact the digital switching noise has on the operation of the analog circuits. The power, grounding, and layout recommendations in this section will help provide the best performance from the MxFE.

COMPONENT PLACEMENT

Chances for obtaining the best performance from the MxFE are greatly increased if the three following guidelines of component placement are followed.

- Manage the path of return currents flowing into the ground plane so that high frequency switching currents from the digital circuits do not flow onto the ground plane under the MxFE or analog circuits.
- Keep noisy digital signal paths and sensitive receive signal paths as short as possible.
- Keep digital (noise generating) and analog (noise susceptible) circuits as far away from each other as possible.

To best manage the return currents, pure digital circuits that generate high switching currents should be closest to the power supply entry. This keeps the highest frequency return current paths short and prevents them from traveling over the sensitive MxFE and analog portions of the ground plane. Also, these circuits should be generously bypassed at each device, further reducing the high frequency ground currents. The MxFE should be placed adjacent to the digital circuits, such that the ground return currents from the digital sections do not flow into the ground plane under the MxFE. The analog circuits should be placed furthest from the power supply.

The AD9877 has several pins that are used to decouple sensitive internal nodes. These pins are REFIO, REFB8, REFT8, REFB12, and REFT12. The decoupling capacitors connected to these points should have low ESR and ESL. These capacitors should be placed as close as possible to the MxFE and be connected directly to the analog ground plane.

The resistor connected to the FSADJ pin and the RC network connected to the PLLFILT pin should also be placed close to the device and connected directly to the analog ground plane.

POWER PLANES AND DECOUPLING

The AD9877 evaluation board demonstrates a good power supply distribution and decoupling strategy. The board has four layers: two signal layers, one ground plane, and one power plane. The power plane is split into a 3 VDD section used for the 3 V analog supply pins of the AD9877 and a VANLG section that supplies the higher voltage analog components on the board.

That 3 VDD section typically has the highest frequency currents on the power plane and should be kept the farthest from the MxFE and analog sections of the board. The DVDD portion of the plane brings the current used to power the digital portion of the MxFE to the device. This should be treated similarly to the 3 VDD power plane and be kept from going underneath the MxFE or analog components. The MxFE should sit above the AVDD portion of the power plane.

The AVDD and DVDD power planes can be fed from the same low noise voltage source. They should be decoupled from each other, however, to prevent the noise generated in the DVDD portion of the MxFE from corrupting the AVDD supply. This can be done by using ferrite beads between the voltage source and DVDD and between the source and AVDD. Both DVDD and AVDD should have a low ESR, bulk decoupling capacitor on the MxFE side of the ferrite as well as low ESR, low ESL decoupling capacitors on each supply pin (for example, the AD9877 requires 17 power supply decoupling caps). The decoupling capacitors should be placed as close as possible to the MxFE supply pins. An example of the proper decoupling is shown in the AD9877 evaluation board schematic.

GROUND PLANES

In general, if the component placing guidelines discussed in the Component Placement section can be implemented, it is best to have at least one continuous ground plane for the entire board. All ground connections should be made as short as possible. This results in the lowest impedance return paths and the quietest ground connections.

If the components cannot be placed in a manner that keeps the high frequency ground currents from traversing under the MxFE and analog components, it may be necessary to put current steering channels into the ground plane to route the high frequency currents around these sensitive areas. These current steering channels should be made only when and where necessary.

SIGNAL ROUTING

The digital Rx and Tx signal paths should be kept as short as possible. Also, these traces should have a controlled impedance of about $50\ \Omega$. This prevents poor signal integrity and the high currents that can occur during undershoot or overshoot caused by ringing. If the signal traces cannot be kept shorter than approximately 1.5 inches, then series termination resistors ($33\ \Omega$ to $47\ \Omega$) should be placed close to all signal sources. It is a good idea to series terminate all clock signals at their source regardless of trace length.

The receive (I IN, Q IN, and RF IN) signals are the most sensitive signals on the board. Careful routing of these signals is essential for good receive path performance. The Rx \pm signals form a differential pair and should be routed together as a pair. By keeping the traces adjacent to each other, noise coupled onto the signals appears as common-mode and is largely rejected by the MxFE receive input. Keeping the driving point impedance of the receive signal low and placing any low-pass filtering of the signals close to the MxFE further reduces the possibility of noise corrupting these signals.

OUTLINE DIMENSIONS

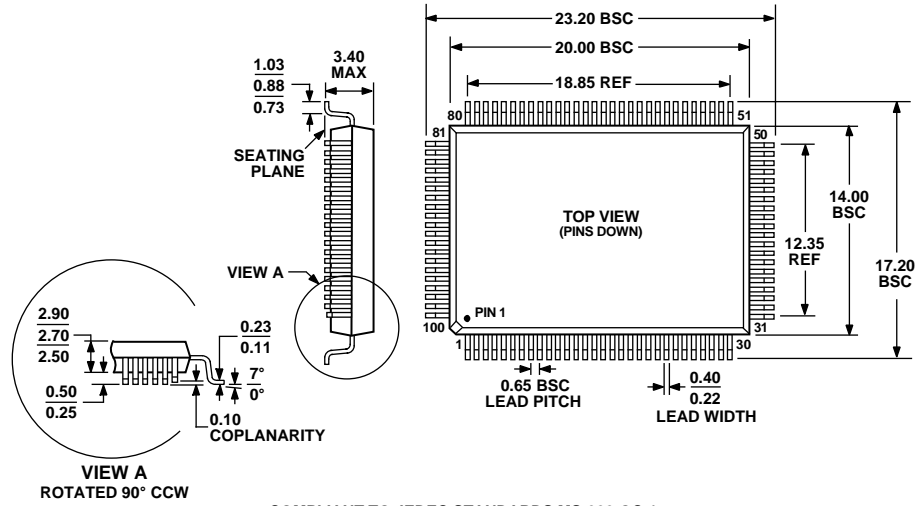

COMPLIANT TO JEDEC STANDARDS MS-022-GC-1

Figure 44. 100-Lead Metric Quad Flat Package [MQFP] (S-100-3)

Dimensions shown in millimeters

ORDERING GUIDE

Model	Temperature Range	Package Description	Package Option
AD9877ABS	-40°C to +85°C	100-Lead Metric Quad Flat Package [MQFP]	S-100-3
AD9877-EB		Evaluation Board	

AD9877

NOTES