

BIPOLAR ANALOG INTEGRATED CIRCUIT

$\mu$ PC1094

SWITCHING REGULATOR CONTROL CIRCUIT  
FOR 500 kHz OPERATION

DESCRIPTION

$\mu$ PC1094C,  $\mu$ PC1094G are PWM type switching regulator control circuit up to 500 kHz switching frequency.

These devices feature low standby current, totem pole output circuit which can directly drive the gate of power MOS FET at high speed, and various protection circuits.

These devices are optimum choice for the single ended primary control method switching regulator.

FEATURES

- Directly switching the gate of an external power MOS FET at high speed. ( $I_{C(peak)} = 1.2 A$ )
- Low supply current.
- Internal low voltage stop circuit.
- Internal ON/OFF control circuit.
- Over current sense pin appendant.
- Capable of master slave operation.

ORDERING INFORMATION

Part Number	Package
$\mu$ PC1094C	14-PIN PLASTIC DIP (300 mil)
$\mu$ PC1094G	14-PIN PLASTIC SOP (225 mil)

CONNECTION DIAGRAM (Top View)

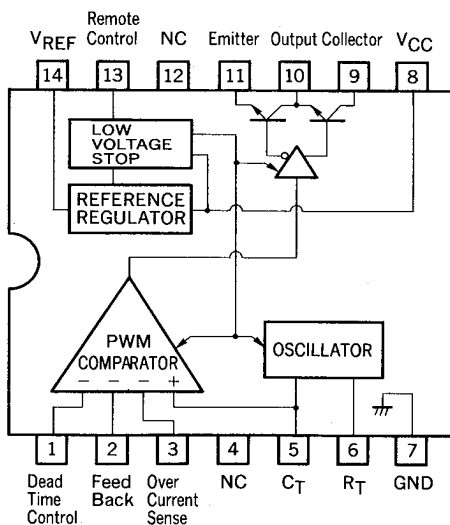

NEC cannot assume any responsibility for any circuits shown or represent that they are free from patent infringement.

**ABSOLUTE MAXIMUM RATINGS (T<sub>a</sub> = 25 °C)**

Supply Voltage	V <sub>CC</sub>	26	V
Output Voltage	V <sub>C</sub>	26	V
Output Current (DC)	I <sub>C(DC)</sub>	100	mA
Output Current (Peak)	I <sub>C(peak)</sub>	1.2	A
Total Power Dissipation	μPC1094C	P <sub>T</sub>	570 mW
	μPC1094G	P <sub>T</sub>	550 mW
Operating Temperature Range	T <sub>opt</sub>	-20 to +85	°C
Storage Temperature Range	T <sub>stg</sub>	-55 to +150	°C

**RECOMMENDED OPERATING CONDITIONS**

CHARACTERISTIC	SYMBOL	MIN.	TYP.	MAX.	UNIT
Supply Voltage	V <sub>CC</sub>	11	15	24	V
Oscillation Frequency	f <sub>osc</sub>	50	200	500	kHz
Output Load Capacitance	C <sub>L</sub>		2 200	3 000	pF

**OPERATING WAVEFORM**

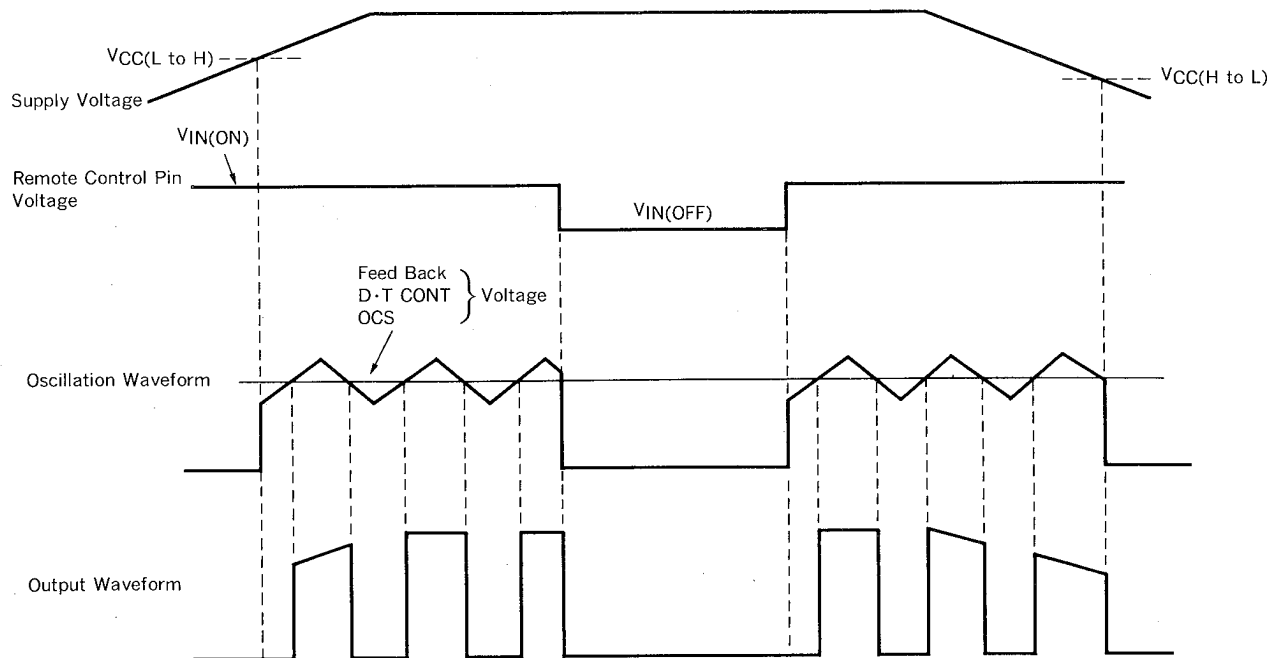

ELECTRICAL CHARACTERISTICS ( $T_a = 25\text{ }^\circ\text{C}$ ,  $V_{CC} = 15\text{ V}$ ,  $R_T \cong 36\text{ k}\Omega$ ,  $C_T = 1\text{ }000\text{ pF}$ ,  $f_{osc} = 200\text{ kHz}$ )

BLOCK	CHARACTERISTIC	SYMBOL	MIN.	TYP.	MAX.	UNIT	TEST CONDITIONS
	Stand-by Current	$I_{CC(SB)}$		0.9	1.6	mA	$V_{CC} = 8\text{ V}$ , $-10\text{ }^\circ\text{C} \leq T_a \leq +85\text{ }^\circ\text{C}$
	Circuit Current	$I_{CC}$		6	10	mA	$V_{CC} = V_C = 20\text{ V}$ , $V_D = 2.15\text{ V}$ No Load *1
Low Voltage Stop Circuit	Start-up Voltage	$V_{CC(LtoH)}$	9.6	10.3	11	V	
	Hysteresis Voltage	$V_H$	1.8	2.0	2.2	V	
Reference Voltage Circuit	Reference Voltage	$V_{REF}$	4.75	5.0	5.25	V	$I_{REF} = 0$
	Line Regulation	$REG_{LN}$		1	10	mV	$11\text{ V} \leq V_{CC} \leq 20\text{ V}$ , $I_{REF} = 0$
	Load Regulation	$REG_L$		6.5	12	mV	$0 \leq I_{REF} \leq 3\text{ mA}$
	Temperature Coefficient	$\Delta V_{REF}/\Delta T$		400	700	$\mu\text{V}/^\circ\text{C}$	$I_{REF} = 0$ , $-10\text{ }^\circ\text{C} \leq T_a \leq +85\text{ }^\circ\text{C}$
	Short Circuit Current	$I_{short}$		13		mA	$V_{REF} = 0$
PWM Circuit	Input Bias Current	$I_B$			10	$\mu\text{A}$	
	Low Level Threshold Voltage	$V_{TH(L)}$		1.6		V	
	High Level Threshold Voltage	$V_{TH(H)}$		2.5		V	
	Dead Time Temperature Coefficient			3		%	$V_D = 0.43 V_{REF}$ , $-10\text{ }^\circ\text{C} \leq T_a \leq +85\text{ }^\circ\text{C}$
Oscillator Circuit	Oscillation Frequency	$f_{osc}$	180	200	220	kHz	
	Frequency Line Regulation	$\Delta f/\Delta V$		1		%	$11\text{ V} \leq V_{CC} \leq 20\text{ V}$
	Frequency Temperature Coefficient	$\Delta f/\Delta T$		2	5	%	$-10\text{ }^\circ\text{C} \leq T_a \leq +85\text{ }^\circ\text{C}$
Output Circuit	Low Level Output Voltage	$V_{OL}$			0.5	V	$I_{SINK} = 3\text{ mA}$ *1
	High Level Output Voltage	$V_{OH}$		$V_{CC}-1.6$		V	$I_{SOURCE} = 30\text{ mA}$ *1
	Output Voltage Rise Time	$t_r$		60		ns	$R_L = 15\text{ }\Omega$ , $C_L = 2\text{ }200\text{ pF}$ *1, *2
	Output Voltage Fall Time	$t_f$		40		ns	
Remote Control Circuit	Input Voltage (ON)	$V_{IN(ON)}$			2.4	V	
	Input Voltage (OFF)	$V_{IN(OFF)}$	0.5			V	

\*1  $V_{CC}$  – Collector (pin 9) connection, GND – Emitter (pin 11) connection

\*2  $R_L$ : Load Resistance  $C_L$ : Load Capacitance

TYPICAL CHARACTERISTICS ( $T_a = 25^\circ\text{C}$ ,  $V_{CC} = 15\text{V}$ )

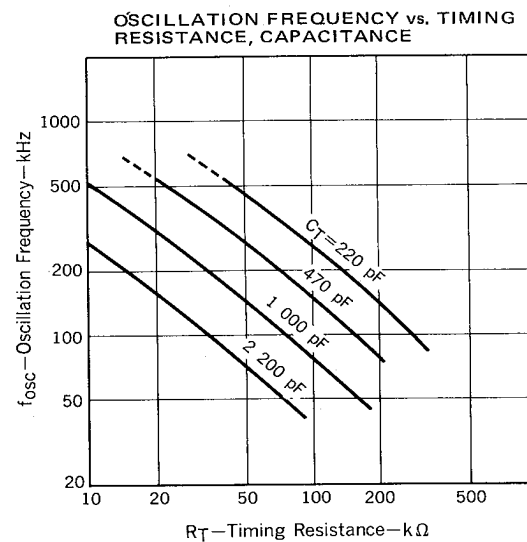
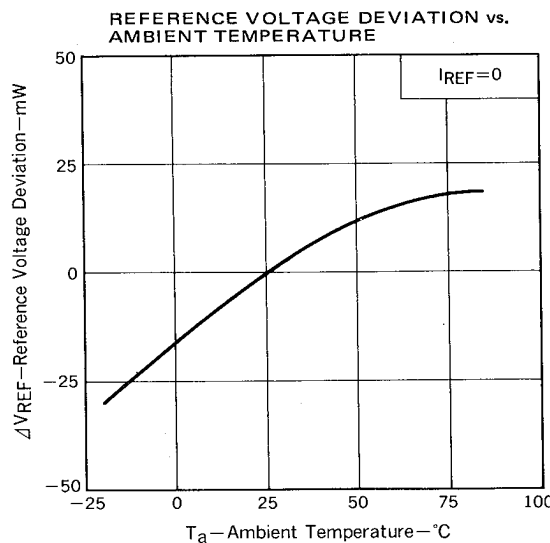
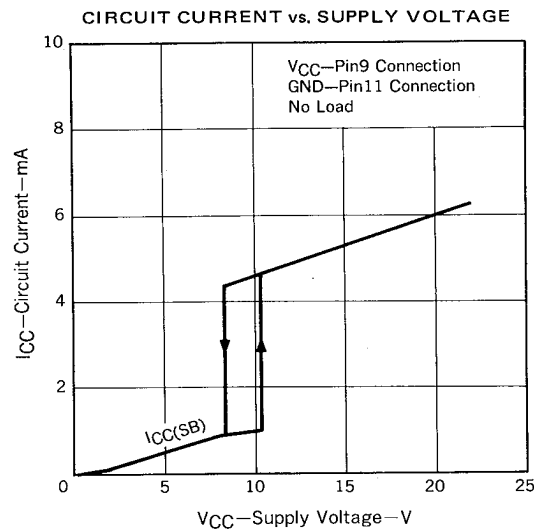
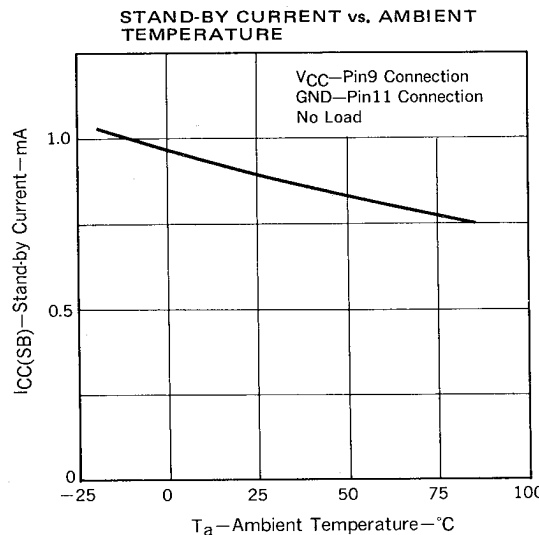
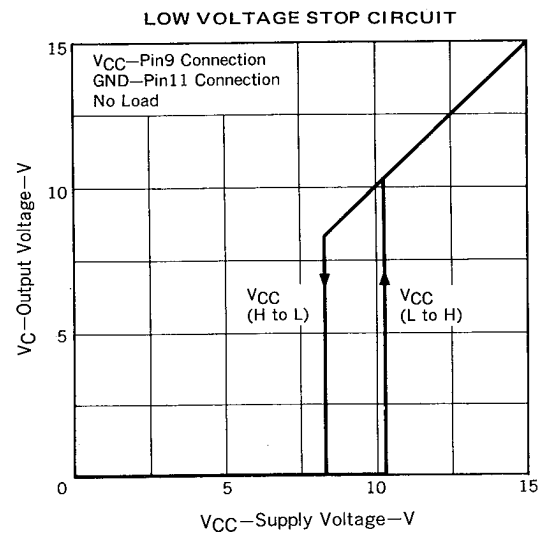
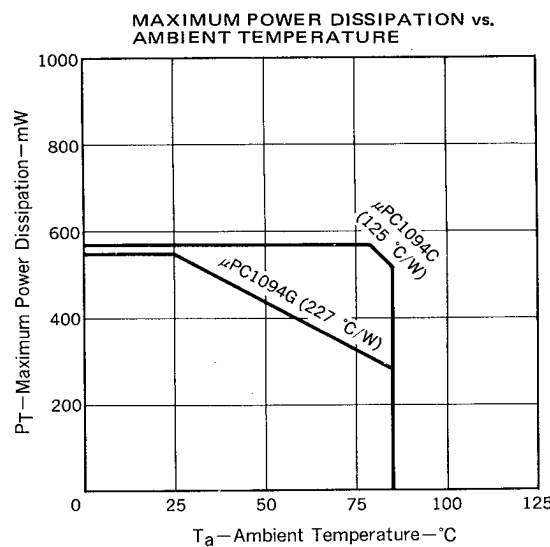

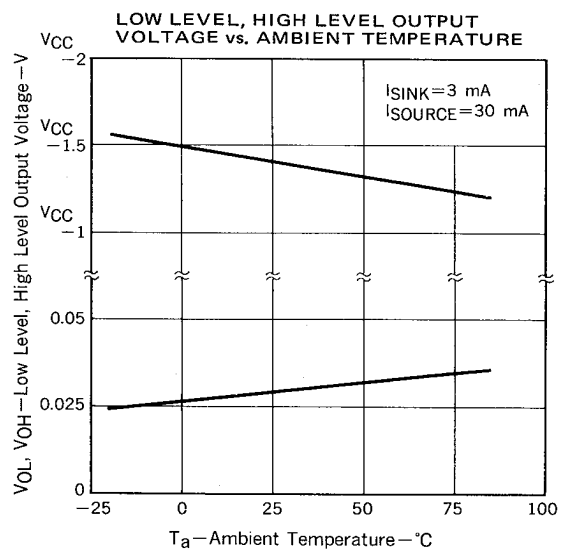
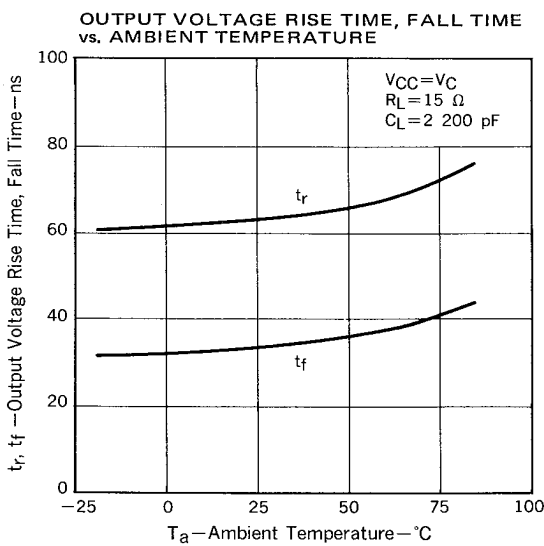
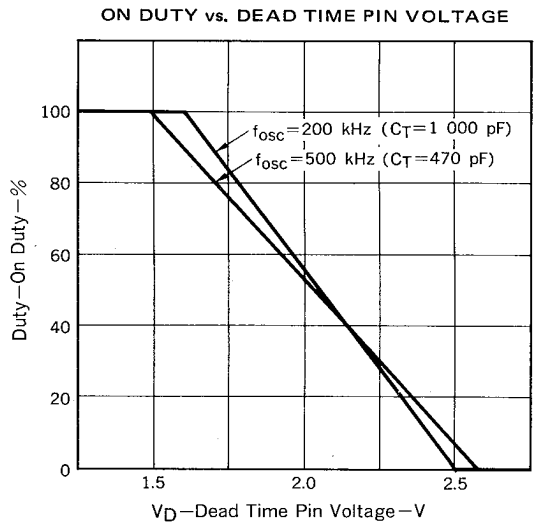
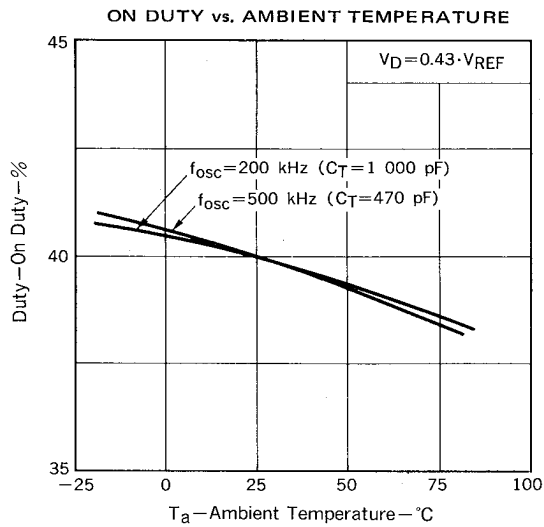
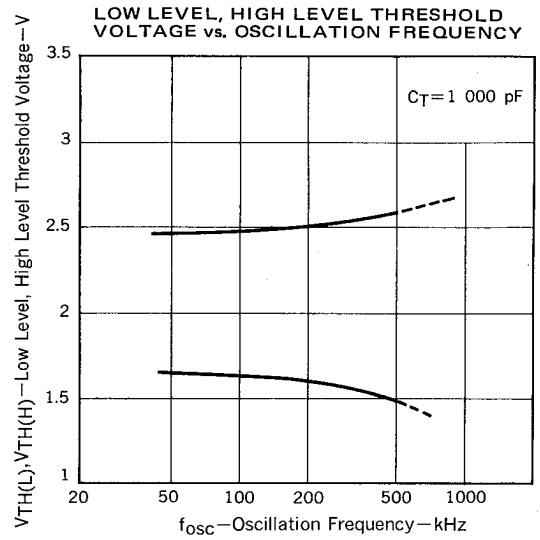
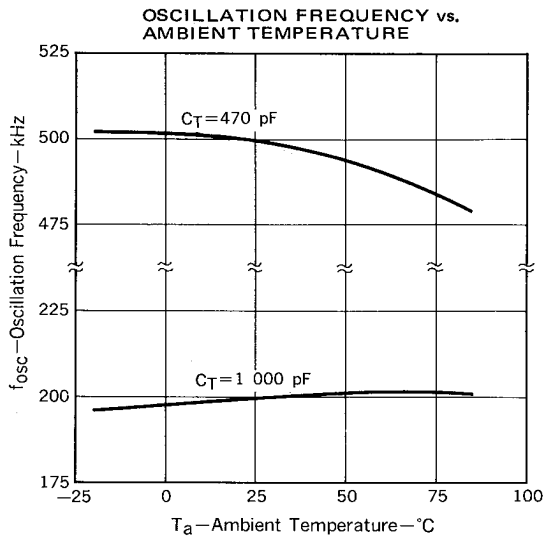



14-Pin Plastic DIP (300 mil)

(C Package)

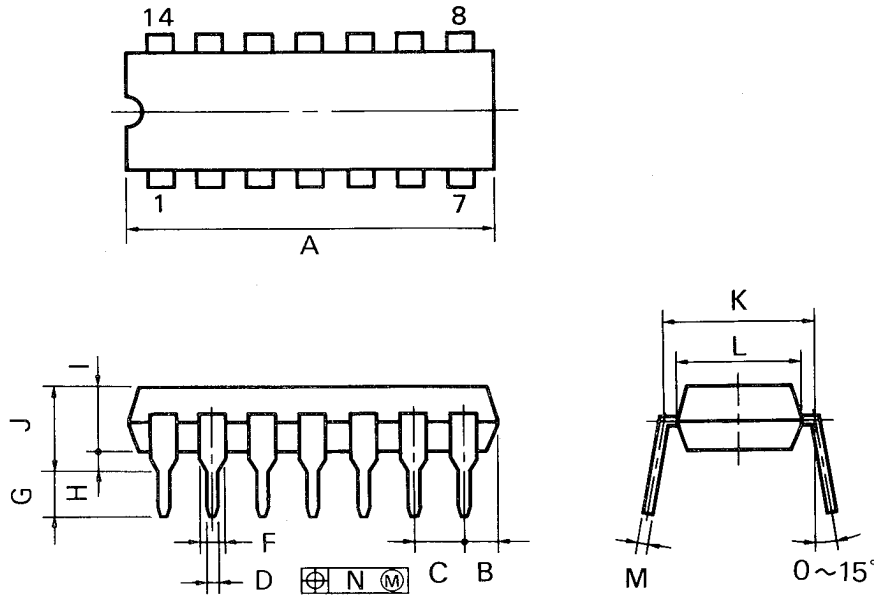

P14C-100-300B1

NOTES

- 1) Each lead centerline is located within 0.25 mm (0.01 inch) of its true position (T.P.) at maximum material condition.
- 2) Item "K" to center of leads when formed parallel.

ITEM	MILLIMETERS	INCHES
A	20.32 MAX.	0.800 MAX.
B	2.54 MAX.	0.100 MAX.
C	2.54 (T.P.)	0.100 (T.P.)
D	0.50 $\pm 0.10$	0.020 $\pm 0.004$
F	1.2 MIN.	0.047 MIN.
G	3.6 $\pm 0.3$	0.142 $\pm 0.012$
H	0.51 MIN.	0.020 MIN.
I	4.31 MAX.	0.170 MAX.
J	5.08 MAX.	0.200 MAX.
K	7.62 (T.P.)	0.300 (T.P.)
L	6.4	0.252
M	0.25 $\pm 0.05$	0.010 $\pm 0.003$
N	0.25	0.01

14-Pin Plastic SOP (225 mil)

(G Package)

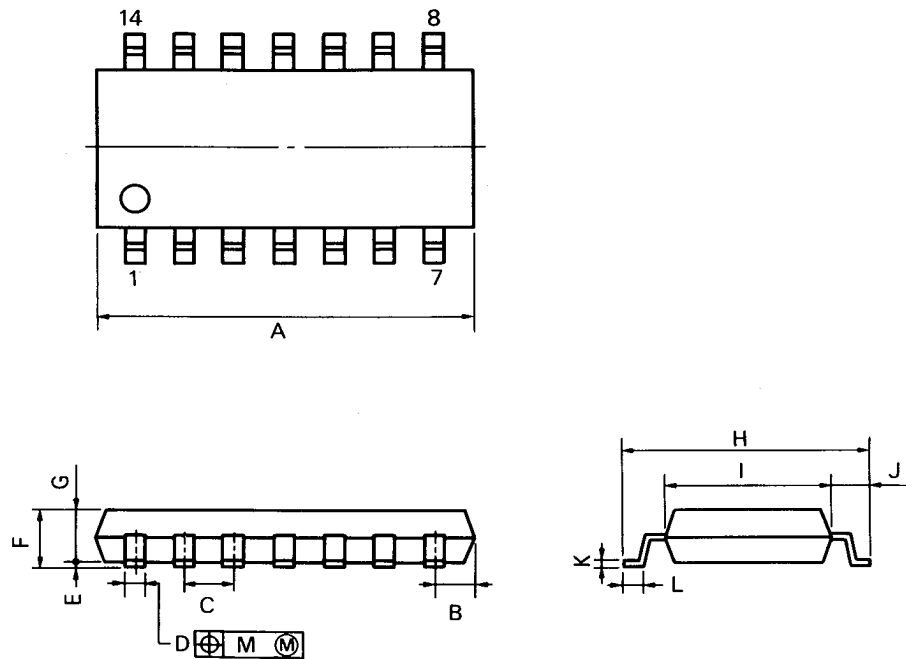

S14GM-50-225B, C

NOTE

Each lead centerline is located within 0.12 mm (0.005 inch) of its true position (T.P.) at maximum material condition.

ITEM	MILLIMETERS	INCHES
A	10.46 MAX.	0.412 MAX.
B	1.42 MAX.	0.056 MAX.
C	1.27 (T.P.)	0.050 (T.P.)
D	0.40 <sup>+0.10</sup> <sub>-0.08</sub>	0.016 <sup>+0.004</sup> <sub>-0.003</sub>
E	0.1 <sup>+0.1</sup>	0.004 <sup>+0.004</sup>
F	1.8 MAX.	0.071 MAX.
G	1.49	0.059
H	6.5 <sup>+0.3</sup>	0.256 <sup>+0.012</sup>
I	4.4	0.173
J	1.1	0.043
K	0.15 <sup>+0.10</sup> <sub>-0.05</sub>	0.006 <sup>+0.004</sup> <sub>-0.002</sub>
L	0.6 <sup>+0.2</sup>	0.024 <sup>+0.008</sup> <sub>-0.008</sub>
M	0.12	0.005