



# DS2030Y/AB Single-Piece 256kb Nonvolatile SRAM

DS2030Y/AB

## General Description

The DS2030 is a 256kb reflowable nonvolatile (NV) SRAM, which consists of a static RAM (SRAM), an NV controller, and an internal rechargeable manganese lithium (ML) battery. These components are encased in a surface-mount module with a 256-ball BGA footprint. Whenever V<sub>CC</sub> is applied to the module, it recharges the ML battery, powers the SRAM from the external power source, and allows the contents of the SRAM to be modified. When V<sub>CC</sub> is powered down or out of tolerance, the controller write-protects the SRAM's contents and powers the SRAM from the battery. Two versions of the DS2030 are available, which provide either a 5% or 10% power-monitoring trip point. The DS2030 also contains a power-supply monitor output,  $\overline{\text{RST}}$ , which can be used as a CPU supervisor for a microprocessor.

## Features

- ◆ Single-Piece, Reflowable, 27mm<sup>2</sup> PBGA Package Footprint
- ◆ Internal ML Battery and Charger
- ◆ Unconditionally Write-Protects SRAM when V<sub>CC</sub> is Out-of-Tolerance
- ◆ Automatically Switches to Battery Supply when V<sub>CC</sub> Power Failures Occur
- ◆ Internal Power-Supply Monitor Detects Power Fail at 5% or 10% Below Nominal V<sub>CC</sub> (5V)
- ◆ Reset Output can be used as a CPU Supervisor for a Microprocessor
- ◆ Industrial Temperature Range (-40°C to +85°C)
- ◆ UL Recognized

## Applications

RAID Systems and Servers	POS Terminals
Industrial Controllers	Data-Acquisition Systems
Gaming	Fire Alarms
Router/Switches	PLC

Pin Configuration appears at end of data sheet.

## Ordering Information

PART	TEMP RANGE	PIN-PACKAGE	SPEED (ns)	SUPPLY TOLERANCE (%)
DS2030AB-70	-40°C to +85°C	256 Ball 27mm <sup>2</sup> BGA Module	70	5
DS2030AB-100	-40°C to +85°C	256 Ball 27mm <sup>2</sup> BGA Module	100	5
DS2030Y-70	-40°C to +85°C	256 Ball 27mm <sup>2</sup> BGA Module	70	10
DS2030Y-100	-40°C to +85°C	256 Ball 27mm <sup>2</sup> BGA Module	100	10

## Typical Operating Circuit

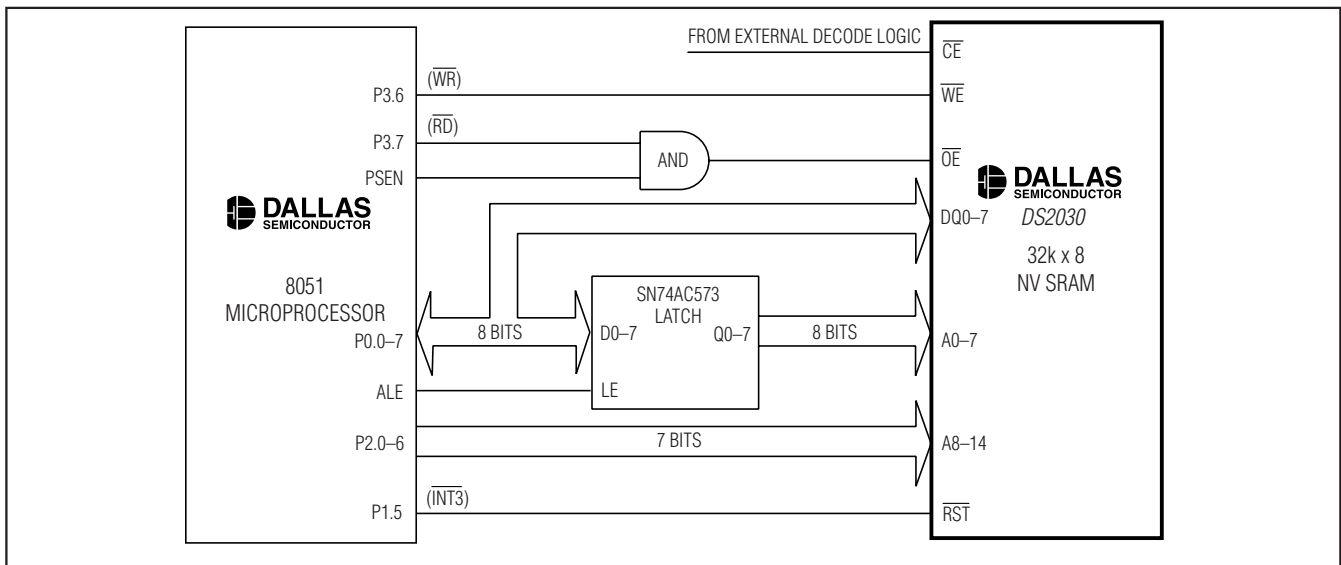

For pricing, delivery, and ordering information, please contact Maxim/Dallas Direct! at 1-888-629-4642, or visit Maxim's website at [www.maxim-ic.com](http://www.maxim-ic.com).

# DS2030Y/AB Single-Piece 256kb Nonvolatile SRAM

## ABSOLUTE MAXIMUM RATINGS

Voltage on Any Pin Relative to Ground .....-0.3V to +6.0V  
 Operating Temperature Range .....-40°C to +85°C

Storage Temperature Range .....-40°C to +85°C  
 Soldering Temperature.....See IPC/JEDEC J-STD-020C

*Stresses beyond those listed under "Absolute Maximum Ratings" may cause permanent damage to the device. These are stress ratings only, and functional operation of the device at these or any other conditions beyond those indicated in the operational sections of the specifications is not implied. Exposure to absolute maximum rating conditions for extended periods may affect device reliability.*

## RECOMMENDED OPERATING CONDITIONS

(T<sub>A</sub> = -40°C to +85°C)

PARAMETER	SYMBOL	CONDITIONS	MIN	TYP	MAX	UNITS
Supply Voltage	V <sub>CC</sub>	DS2030AB	4.75		5.25	V
		DS2030Y	4.50		5.50	
Input Logic 1	V <sub>IH</sub>		2.2		V <sub>CC</sub>	V
Input Logic 0	V <sub>IL</sub>		0		0.8	V

## DC ELECTRICAL CHARACTERISTICS

(V<sub>CC</sub> = 5V ±5% for DS2030AB, V<sub>CC</sub> = 5V ±10% for DS2030Y, T<sub>A</sub> = -40°C to +85°C.)

PARAMETER	SYMBOL	CONDITIONS	MIN	TYP	MAX	UNITS
Input Leakage Current	I <sub>IL</sub>		-1.0		+1.0	μA
I/O Leakage Current	I <sub>IO</sub>	$\overline{CE} = V_{CC}$	-1.0		+1.0	μA
Output-Current High	I <sub>OH</sub>	At 2.4V	-1.0			mA
Output-Current Low	I <sub>OL</sub>	At 0.4V	2.0			mA
Output-Current Low $\overline{RST}$	I <sub>OL</sub> $\overline{RST}$	At 0.4V (Note 1)	10.0			mA
Standby Current	I <sub>CCS1</sub>	$\overline{CE} = 2.2V$		0.5	7	mA
	I <sub>CCS2</sub>	$\overline{CE} = V_{CC} - 0.5V$		0.2	5	
Operating Current	I <sub>CCO1</sub>	t <sub>RC</sub> = 200ns, outputs open			85	mA
Write Protection Voltage	V <sub>TP</sub>	DS2030AB	4.50	4.62	4.75	V
		DS2030Y	4.25	4.37	4.50	

## CAPACITANCE

(T<sub>A</sub> = +25°C)

PARAMETER	SYMBOL	CONDITIONS	MIN	TYP	MAX	UNITS
Input Capacitance	C <sub>IN</sub>	Not tested		7		pF
Input/Output Capacitance	C <sub>OUT</sub>	Not tested		7		pF

# DS2030Y/AB Single-Piece 256kb Nonvolatile SRAM

**DS2030Y/AB**

## AC ELECTRICAL CHARACTERISTICS

(V<sub>CC</sub> = 5V ±5% for DS2030AB, V<sub>CC</sub> = 5V ±10% for DS2030Y, T<sub>A</sub> = -40°C to +85°C.)

PARAMETER	SYMBOL	CONDITIONS	DS2030AB-70 DS2030Y-70		DS2030AB-100 DS2030Y-100		UNITS
			MIN	MAX	MIN	MAX	
Read Cycle Time	t <sub>RC</sub>		70		100		ns
Access Time	t <sub>ACC</sub>			70		100	ns
$\overline{\text{OE}}$ to Output Valid	t <sub>OE</sub>			35		50	ns
$\overline{\text{CE}}$ to Output Valid	t <sub>CO</sub>			70		100	ns
$\overline{\text{OE}}$ or $\overline{\text{CE}}$ to Output Active	t <sub>COE</sub>	(Note 2)	5		5		ns
Output High Impedance from Deselection	t <sub>OD</sub>	(Note 2)		25		35	ns
Output Hold from Address Change	t <sub>OH</sub>		5		5		ns
Write Cycle Time	t <sub>WC</sub>		70		100		ns
Write Pulse Width	t <sub>WP</sub>	(Note 3)	55		75		ns
Address Setup Time	t <sub>AW</sub>		0		0		ns
Write Recovery Time	t <sub>WR1</sub>	(Note 4)	5		5		ns
	t <sub>WR2</sub>	(Note 5)	15		15		
Output High Impedance from $\overline{\text{WE}}$	t <sub>ODW</sub>	(Note 2)		25		35	ns
Output Active from $\overline{\text{WE}}$	t <sub>OE<sub>W</sub></sub>	(Note 2)	5		5		ns
Data Setup Time	t <sub>DS</sub>	(Note 6)	30		40		ns
Data Hold Time	t <sub>DH1</sub>	(Note 4)	0		0		ns
	t <sub>DH2</sub>	(Note 5)	10		10		

## POWER-DOWN/POWER-UP TIMING

(T<sub>A</sub> = -40°C to +85°C)

PARAMETER	SYMBOL	CONDITIONS	MIN	TYP	MAX	UNITS
V <sub>CC</sub> Fail Detect to $\overline{\text{CE}}$ and $\overline{\text{WE}}$ Inactive	t <sub>PD</sub>	(Note 7)			1.5	μs
V <sub>CC</sub> Slew from V <sub>TP</sub> to 0V	t <sub>F</sub>		150			μs
V <sub>CC</sub> Slew from 0V to V <sub>TP</sub>	t <sub>R</sub>		150			μs
V <sub>CC</sub> Valid to $\overline{\text{CE}}$ and $\overline{\text{WE}}$ Inactive	t <sub>PU</sub>				2	ms
V <sub>CC</sub> Valid to End of Write Protection	t <sub>REC</sub>				125	ms
V <sub>CC</sub> Fail Detect to $\overline{\text{RST}}$ Active	t <sub>RPD</sub>	(Note 1)			3.0	μs
V <sub>CC</sub> Valid to $\overline{\text{RST}}$ Inactive	t <sub>RPU</sub>	(Note 1)	225	350	525	ms

## DATA RETENTION

(T<sub>A</sub> = +25°C)

PARAMETER	SYMBOL	CONDITIONS	MIN	TYP	MAX	UNITS
Expected Data-Retention Time (Per Charge)	t <sub>DR</sub>	(Note 8)	2	3		years

# DS2030Y/AB Single-Piece 256kb Nonvolatile SRAM

DS2030Y/AB

## Read Cycle

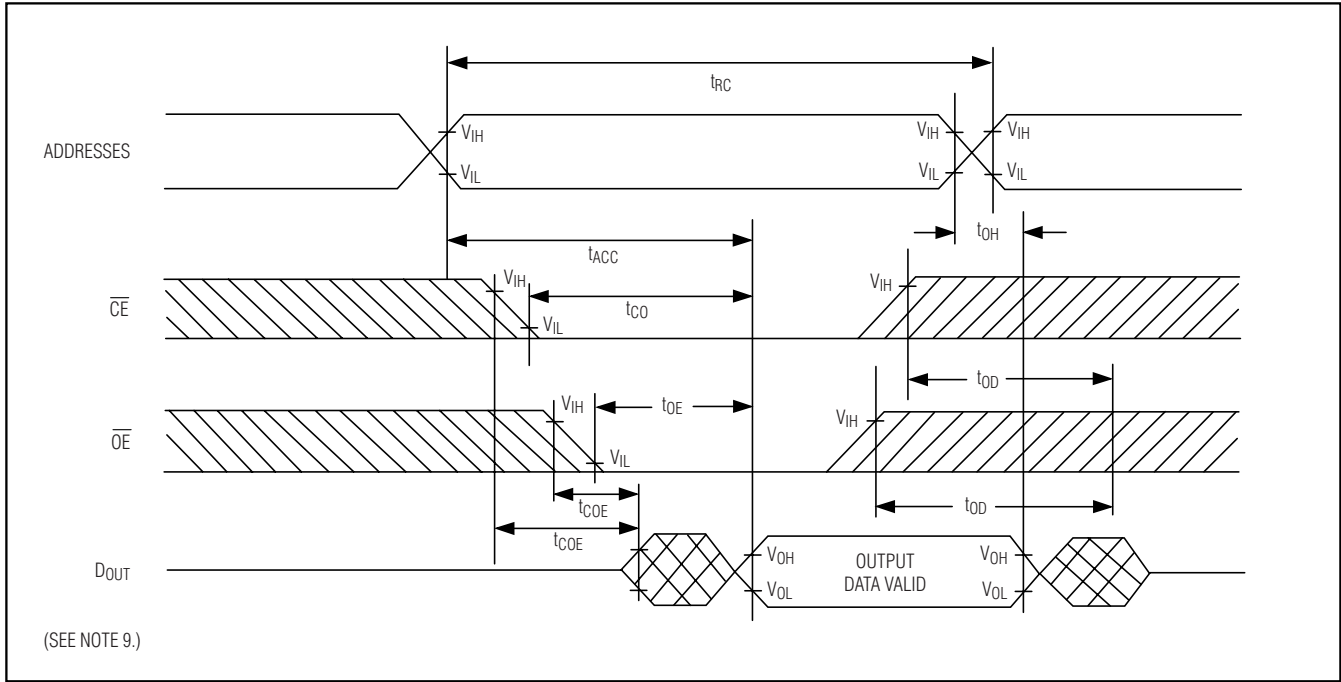

# DS2030Y/AB Single-Piece 256kb Nonvolatile SRAM

DS2030Y/AB

## Write Cycle 1

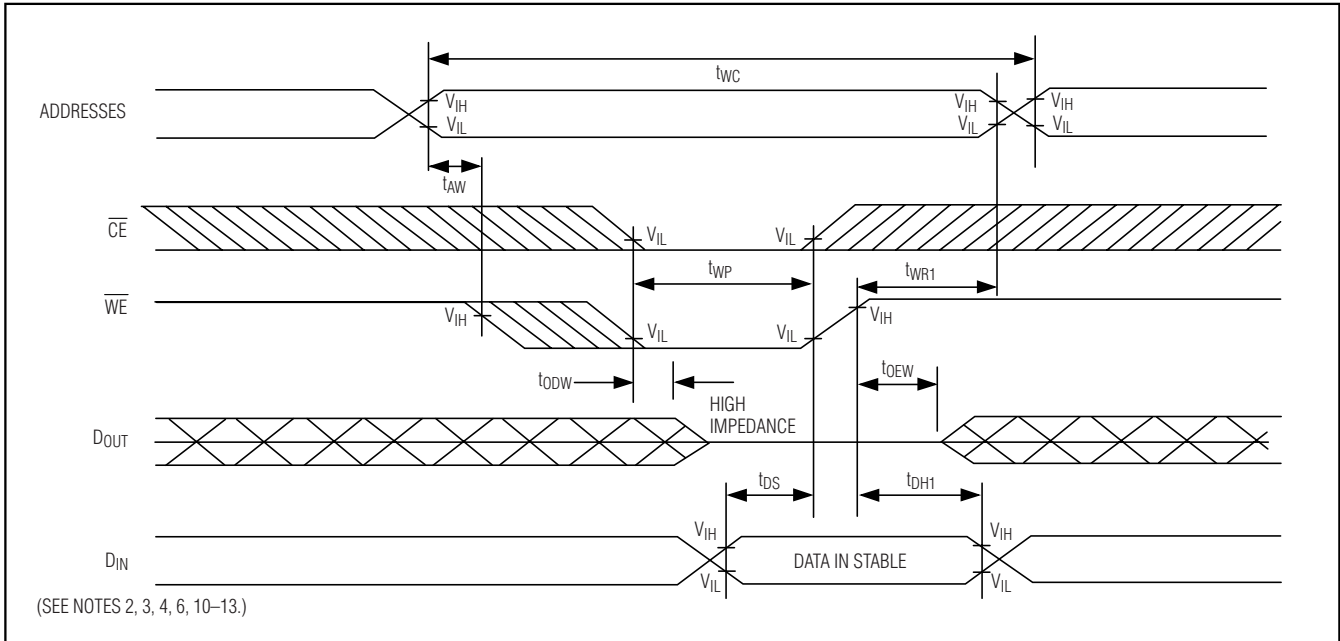

## Write Cycle 2

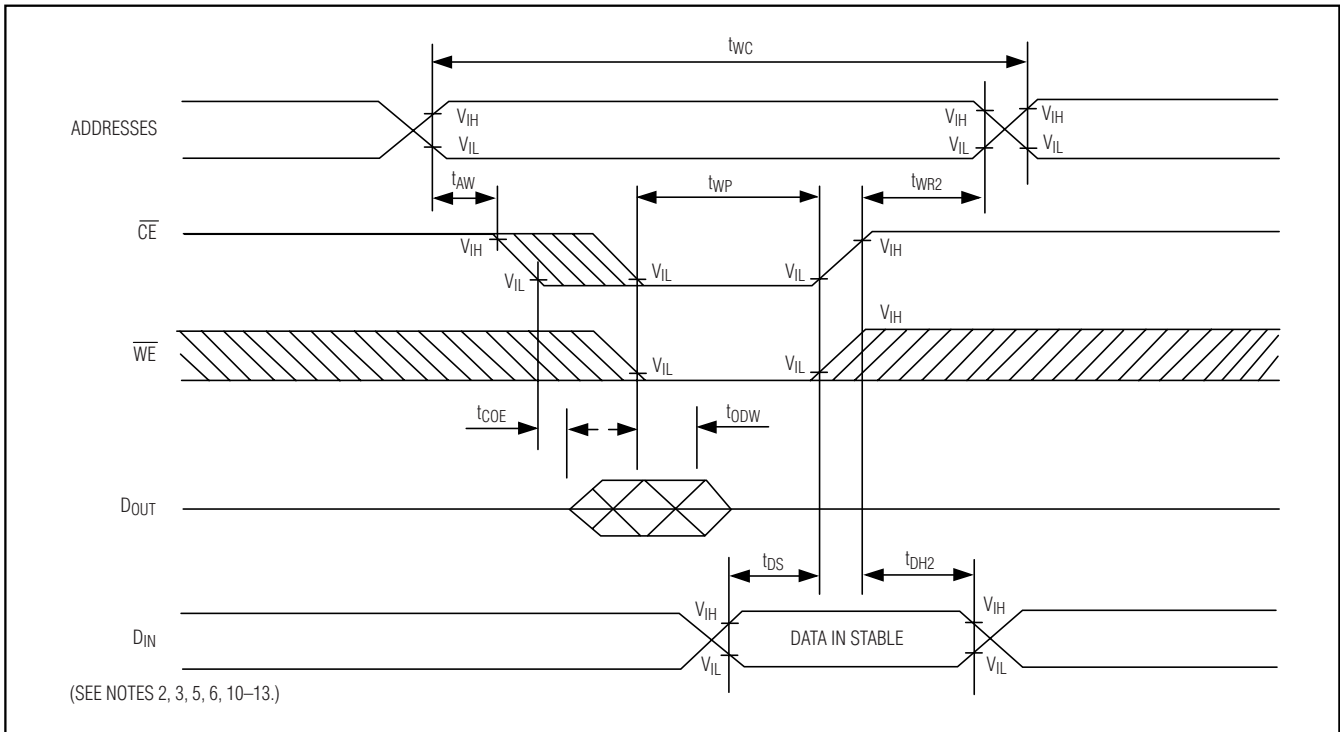

# DS2030Y/AB Single-Piece 256kb Nonvolatile SRAM

## Power-Down/Power-Up Condition

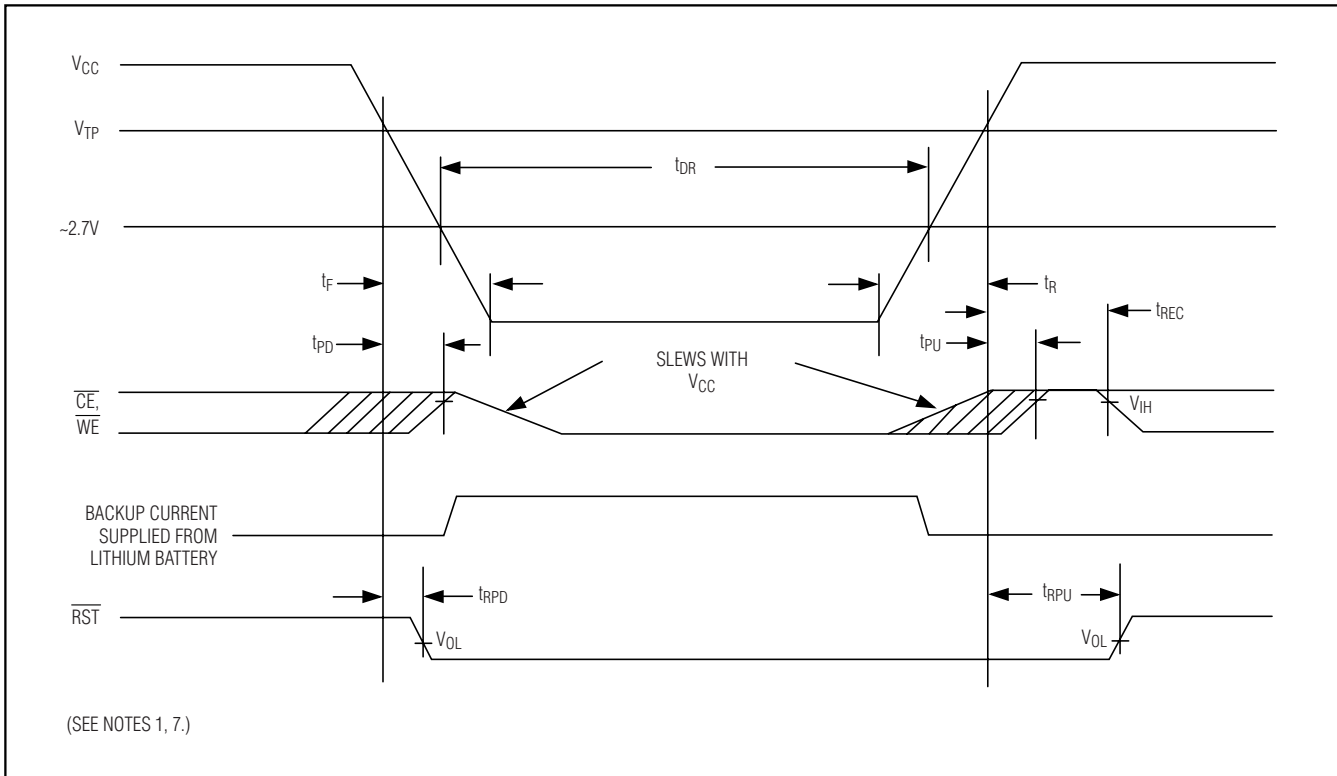

- Note 1:**  $\overline{\text{RST}}$  is an open-drain output and cannot source current. An external pullup resistor should be connected to this pin to realize a logic-high level.
- Note 2:** These parameters are sampled with a 5pF load and are not 100% tested.
- Note 3:**  $t_{WP}$  is specified as the logical AND of  $\overline{\text{CE}}$  and  $\overline{\text{WE}}$ .  $t_{WP}$  is measured from the latter of  $\overline{\text{CE}}$  or  $\overline{\text{WE}}$  going low to the earlier of  $\overline{\text{CE}}$  or  $\overline{\text{WE}}$  going high.
- Note 4:**  $t_{WR1}$  and  $t_{DH1}$  are measured from  $\overline{\text{WE}}$  going high.
- Note 5:**  $t_{WR2}$  and  $t_{DH2}$  are measured from  $\overline{\text{CE}}$  going high.
- Note 6:**  $t_{DS}$  is measured from the earlier of  $\overline{\text{CE}}$  or  $\overline{\text{WE}}$  going high.
- Note 7:** In a power-down condition, the voltage on any pin can not exceed the voltage on  $V_{CC}$ .
- Note 8:** The expected  $t_{DR}$  is defined as accumulative time in the absence of  $V_{CC}$  starting from the time power is first applied by the user. Minimum expected data-retention time is based on a maximum of two 230°C convection solder reflow exposures, followed by a fully charged cell. Full charge occurs with the initial application of  $V_{CC}$  for a minimum of 96 hours. This parameter is assured by component selection, process control, and design. It is not measured directly in production testing.
- Note 9:**  $\overline{\text{WE}}$  is high for a read cycle.
- Note 10:**  $\overline{\text{OE}} = V_{IH}$  or  $V_{IL}$ . If  $\overline{\text{OE}} = V_{IH}$  during write cycle, the output buffers remain in a high-impedance state.
- Note 11:** If the  $\overline{\text{CE}}$  low transition occurs simultaneously with or latter than the  $\overline{\text{WE}}$  low transition, the output buffers remain in a high-impedance state during this period.
- Note 12:** If the  $\overline{\text{CE}}$  high transition occurs prior to or simultaneously with the  $\overline{\text{WE}}$  high transition, the output buffers remain in a high-impedance state during this period.
- Note 13:** If  $\overline{\text{WE}}$  is low or the  $\overline{\text{WE}}$  low transition occurs prior to or simultaneously with the  $\overline{\text{CE}}$  low transition, the output buffers remain in a high-impedance state during this period.
- Note 14:** DS2030 BGA modules are recognized by Underwriters Laboratory (UL) under file E99151.

# DS2030Y/AB Single-Piece 256kb Nonvolatile SRAM

## Typical Operating Characteristics

( $V_{CC} = +5.0V$ ,  $T_A = +25^\circ C$ , unless otherwise noted.)

DS2030Y/AB

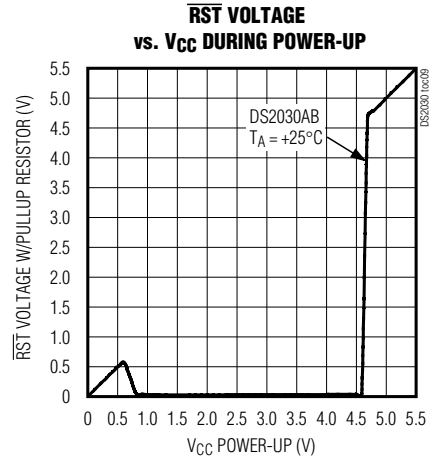
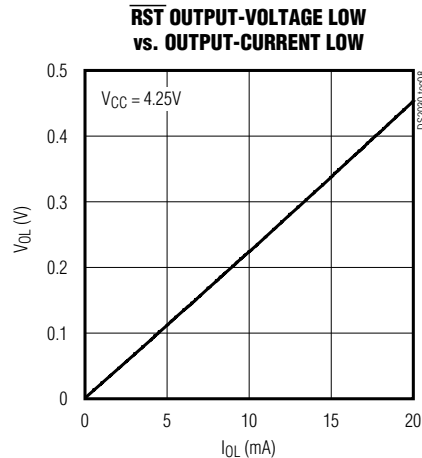
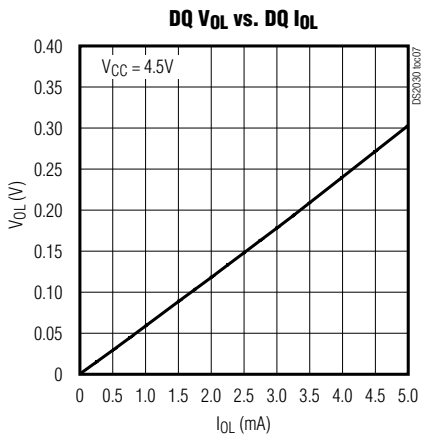
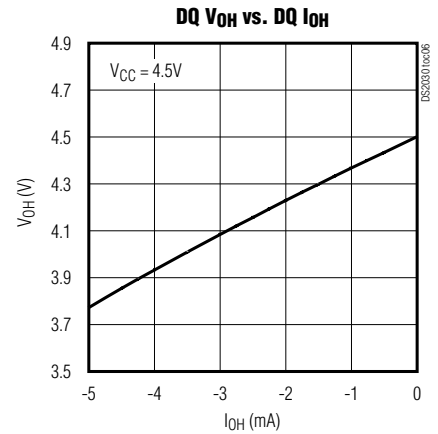
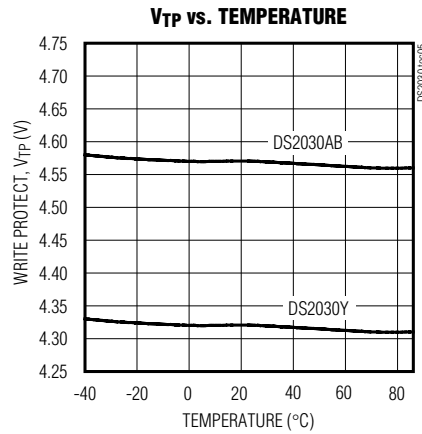
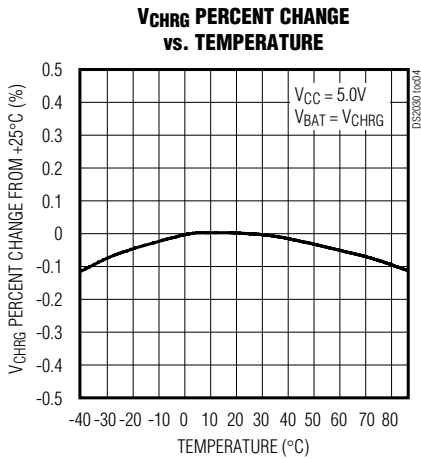
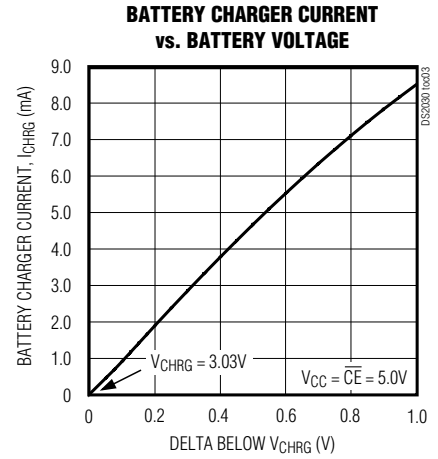
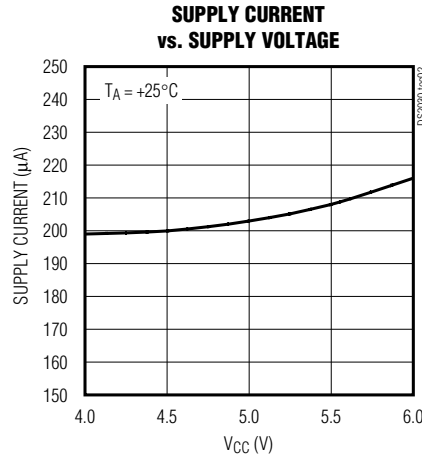
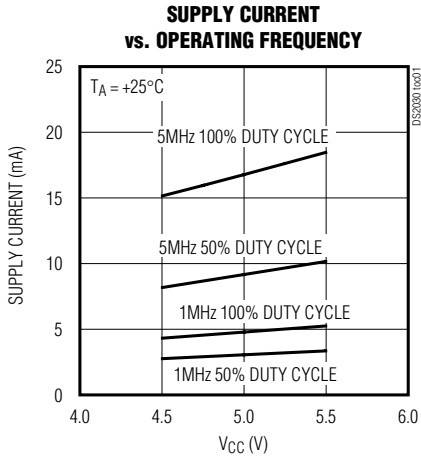

# DS2030Y/AB Single-Piece 256kb Nonvolatile SRAM

**DS2030Y/AB**

## Pin Description

BALLS	NAME	DESCRIPTION
A1, A2, A3, A4	GND	Ground
B1, B2, B3, B4	N.C.	No Connection
C1, C2, C3, C4	N.C.	No Connection
D1, D2, D3, D4	N.C.	No Connection
E1, E2, E3, E4	$\overline{\text{RST}}$	Open-Drain Reset Output
F1, F2, F3, F4	VCC	Supply Voltage
G1, G2, G3, G4	$\overline{\text{WE}}$	Write Enable Input
H1, H2, H3, H4	$\overline{\text{OE}}$	Output Enable Input
J1, J2, J3, J4	$\overline{\text{CE}}$	Chip Enable Input
K1, K2, K3, K4	DQ7	Data Input/Output 7
L1, L2, L3, L4	DQ6	Data Input/Output 6
M1, M2, M3, M4	DQ5	Data Input/Output 5
N1, N2, N3, N4	DQ4	Data Input/Output 4
P1, P2, P3, P4	DQ3	Data Input/Output 3
R1, R2, R3, R4	DQ2	Data Input/Output 2
T1, T2, T3, T4	DQ1	Data Input/Output 1
U1, U2, U3, U4	DQ0	Data Input/Output 0
V1, V2, V3, V4	GND	Ground
W1, W2, W3, W4	GND	Ground
Y1, Y2, Y3, Y4	GND	Ground
A17, A18, A19, A20	GND	Ground
B17, B18, B19, B20	N.C.	No Connection
C17, C18, C19, C20	N.C.	No Connection
D17, D18, D19, D20	A14	Address Input 14
E17, E18, E19, E20	A13	Address Input 13
F17, F18, F19, F20	A12	Address Input 12
G17, G18, G19, G20	A11	Address Input 11
H17, H18, H19, H20	A10	Address Input 10
J17, J18, J19, J20	A9	Address Input 9
K17, K18, K19, K20	A8	Address Input 8
L17, L18, L19, L20	A7	Address Input 7
M17, M18, M19, M20	A6	Address Input 6

BALLS	NAME	DESCRIPTION
N17, N18, N19, N20	A5	Address Input 5
P17, P18, P19, P20	A4	Address Input 4
R17, R18, R19, R20	A3	Address Input 3
T17, T18, T19, T20	A2	Address Input 2
U17, U18, U19, U20	A1	Address Input 1
V17, V18, V19, V20	A0	Address Input 0
W17, W18, W19, W20	GND	Ground
Y17, Y18, Y19, Y20	GND	Ground
A5, B5, C5, D5	N.C.	No Connection
A6, B6, C6, D6	N.C.	No Connection
A7, B7, C7, D7	N.C.	No Connection
A8, B8, C8, D8	N.C.	No Connection
A9, B9, C9, D9	N.C.	No Connection
A10, B10, C10, D10	N.C.	No Connection
A11, B11, C11, D11	N.C.	No Connection
A12, B12, C12, D12	N.C.	No Connection
A13, B13, C13, D13	N.C.	No Connection
A14, B14, C14, D14	N.C.	No Connection
A15, B15, C15, D15	N.C.	No Connection
A16, B16, C16, D16	N.C.	No Connection
U5, V5, W5, Y5	N.C.	No Connection
U6, V6, W6, Y6	N.C.	No Connection
U7, V7, W7, Y7	N.C.	No Connection
U8, V8, W8, Y8	N.C.	No Connection
U9, V9, W9, Y9	N.C.	No Connection
U10, V10, W10, Y10	N.C.	No Connection
U11, V11, W11, Y11	N.C.	No Connection
U12, V12, W12, Y12	N.C.	No Connection
U13, V13, W13, Y13	N.C.	No Connection
U14, V14, W14, Y14	N.C.	No Connection
U15, V15, W15, Y15	N.C.	No Connection
U16, V16, W16, Y16	N.C.	No Connection



# DS2030Y/AB Single-Piece 256kb Nonvolatile SRAM

## Functional Diagram

DS2030Y/AB

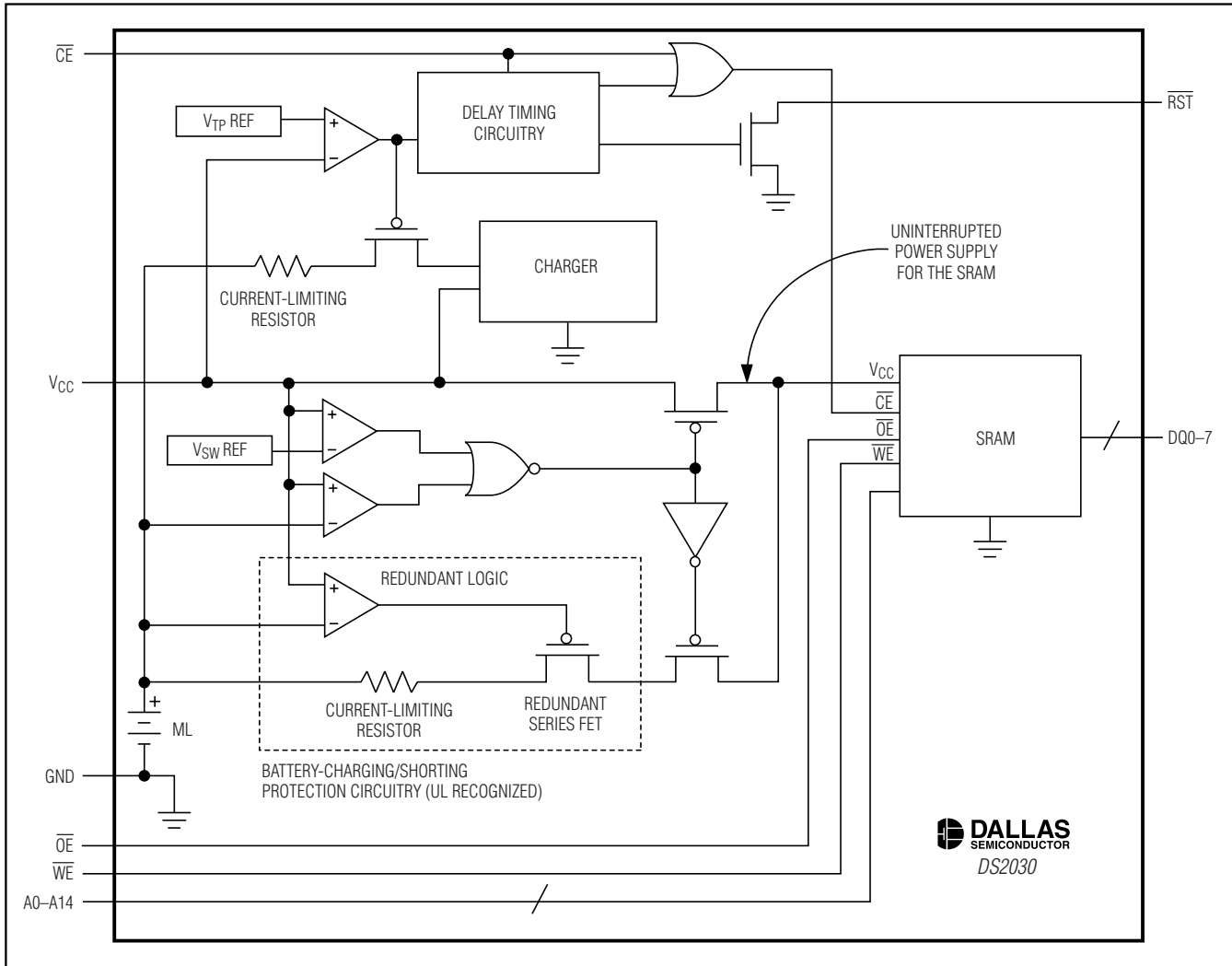

### Detailed Description

The DS2030 is a 256kb (32kb x 8 bits) fully static, NV memory similar in function and organization to the DS1230 NV SRAM, but containing a rechargeable ML battery. The DS2030 NV SRAM constantly monitors VCC for an out-of-tolerance condition. When such a condition occurs, the lithium energy source is automatically switched on and write protection is unconditionally enabled to prevent data corruption. There is no limit to the number of write cycles that can be executed and no additional support circuitry is required for microprocessor interfacing. This device can be used in place of SRAM, EEPROM, or flash components.

The DS2030 assembly consists of a low-power SRAM, an ML battery, and an NV controller with a battery charger, integrated on a standard 256-ball, 27mm<sup>2</sup> BGA substrate. Unlike other surface-mount NV memory modules that require the battery to be removable for soldering, the internal ML battery can tolerate exposure to convection reflow soldering temperatures allowing this single-piece component to be handled with standard BGA assembly techniques.

Two versions of the DS2030 are available that provide either a 5% (DS2030AB) or 10% (DS2030Y) power-monitoring trip point. The DS2030 also contains a power-supply monitor output,  $\overline{RST}$ , which can be used as a CPU supervisor for a microprocessor.

# DS2030Y/AB Single-Piece 256kb Nonvolatile SRAM

## Memory Operation Truth Table

$\overline{WE}$	$\overline{CE}$	$\overline{OE}$	MODE	I <sub>CC</sub>	OUTPUTS
1	0	0	Read	Active	Active
1	0	1	Read	Active	High Impedance
0	0	X	Write	Active	High Impedance
X	1	X	Standby	Standby	High Impedance

X = Don't care.

### Read Mode

The DS2030 executes a read cycle whenever  $\overline{WE}$  (write enable) is inactive (high) and  $\overline{CE}$  (chip enable) is active (low). The unique address specified by the 15 address inputs (A0 to A14) defines which of the 32,768 bytes of data is to be accessed. Valid data will be available to the eight data output drivers within  $t_{ACC}$  (access time) after the last address input signal is stable, providing that  $\overline{CE}$  and  $\overline{OE}$  (output enable) access times are also satisfied. If  $\overline{CE}$  and  $\overline{OE}$  access times are not satisfied, then data access must be measured from the later occurring signal ( $\overline{CE}$  or  $\overline{OE}$ ) and the limiting parameter is either  $t_{CO}$  for  $\overline{CE}$  or  $t_{OE}$  for  $\overline{OE}$  rather than address access.

### Write Mode

The DS2030 executes a write cycle whenever the  $\overline{CE}$  and  $\overline{WE}$  signals are active (low) after address inputs are stable. The later-occurring falling edge of  $\overline{CE}$  or  $\overline{WE}$  will determine the start of the write cycle. The write cycle is terminated by the earlier rising edge of  $\overline{CE}$  or  $\overline{WE}$ . All address inputs must be kept valid throughout the write cycle.  $\overline{WE}$  must return to the high state for a minimum recovery time ( $t_{WR}$ ) before another cycle can be initiated. The  $\overline{OE}$  control signal should be kept inactive (high) during write cycles to avoid bus contention. However, if the output drivers have been enabled ( $\overline{CE}$  and  $\overline{OE}$  active) then  $\overline{WE}$  will disable the outputs in  $t_{ODW}$  from its falling edge.

### Data-Retention Mode

The DS2030AB provides full functional capability for  $V_{CC}$  greater than 4.75V and write-protects at 4.5V. The DS2030Y provides full functional capability for  $V_{CC}$  greater than 4.5V and write-protects at 4.25V. Data is maintained in the absence of  $V_{CC}$  without additional support circuitry. The NV static RAM constantly monitors  $V_{CC}$ . Should the supply voltage decay, the NV SRAM automatically write-protects itself. All inputs become "don't care", and all data outputs become high impedance. As  $V_{CC}$  falls below approximately 2.7V

( $V_{SW}$ ), the power-switching circuit connects the lithium energy source to the RAM to retain data. During power-up, when  $V_{CC}$  rises above  $V_{SW}$ , the power-switching circuit connects external  $V_{CC}$  to the RAM and disconnects the lithium energy source. Normal RAM operation can resume after  $V_{CC}$  exceeds  $V_{TP}$  for a minimum duration of  $t_{REC}$ .

### Battery Charging

When  $V_{CC}$  is greater than  $V_{TP}$ , an internal regulator charges the battery. The UL-approved charger circuit includes short-circuit protection and a temperature-stabilized voltage reference for on-demand charging of the internal battery. Typical data-retention expectations of 3 years *per charge cycle* are achievable.

A maximum of 96 hours of charging time is required to fully charge a depleted battery.

### System Power Monitoring

When the external  $V_{CC}$  supply falls below the selected out-of-tolerance trip point, the output  $\overline{RST}$  is forced active (low). Once active, the  $\overline{RST}$  is held active until the  $V_{CC}$  supply has fallen below that of the internal battery. On power-up, the  $\overline{RST}$  output is held active until the external supply is greater than the selected trip point and one reset timeout period ( $t_{RPU}$ ) has elapsed. This is sufficiently longer than  $t_{REC}$  to ensure that the SRAM is ready for access by the microprocessor.

### Freshness Seal and Shipping

The DS2030 is shipped from Dallas Semiconductor with the lithium battery electrically disconnected, guaranteeing that no battery capacity has been consumed during transit or storage. As shipped, the lithium battery is ~60% charged, and no preassembly charging operations should be attempted.

When  $V_{CC}$  is first applied at a level greater than  $V_{TP}$ , the lithium battery is enabled for backup operation. A 96 hour initial battery charge time is recommended for new system installations.

# DS2030Y/AB Single-Piece 256kb Nonvolatile SRAM

DS2030Y/AB

## Recommended Reflow Temperature Profile

PROFILE FEATURE	Sn-Pb EUTECTIC ASSEMBLY
Average ramp-up rate (T <sub>L</sub> to T <sub>P</sub> )	3°C/second max
Preheat - Temperature min (T <sub>Smin</sub> ) - Temperature max (T <sub>Smax</sub> ) - Time (min to max) (ts)	100°C 150°C 60 to 120 seconds
T <sub>Smax</sub> to T <sub>L</sub> - Ramp-up rate	
Time maintained above: - Temperature (T <sub>L</sub> ) - Time (t <sub>L</sub> )	183°C 60 to 150 seconds
Peak temperature (T <sub>P</sub> )	225 +0/-5°C
Time within 5°C of actual peak temperature (T <sub>P</sub> )	10 to 30 seconds
Ramp-down rate	6°C/second max
Time 25°C to peak temperature	6 minutes max

**Note:** All temperatures refer to top side of the package, measured on the package body surface.

## Recommended Cleaning Procedures

The DS2030 may be cleaned using aqueous-based cleaning solutions. No special precautions are needed when cleaning boards containing a DS2030 module.

Removal of the topside label violates the environmental integrity of the package and voids the warranty of the product.

## Applications Information

### Power-Supply Decoupling

To achieve the best results when using the DS2030, decouple the power supply with a 0.1µF capacitor. Use a high-quality, ceramic surface-mount capacitor if possible. Surface-mount components minimize lead inductance, which improves performance, while ceramic capacitors have adequately high frequency response for decoupling applications.

### Using the Open-Drain $\overline{RST}$ Output

The  $\overline{RST}$  output is open drain, and therefore requires a pullup resistor to realize a high logic output level. Pullup resistor values between 1kΩ and 10kΩ are typical.

### Battery Charging/Lifetime

The DS2030 charges an ML battery to maximum capacity in approximately 96 hours of operation when V<sub>CC</sub> is greater than V<sub>TP</sub>. Once the battery is charged, its lifetime depends primarily on the V<sub>CC</sub> duty cycle. The DS2030 can maintain data from a single, initial charge for up to 3 years. Once recharged, this deep-discharge cycle can be repeated up to 20 times, producing a worst-case service life of 60 years. More typical duty cycles are of shorter duration, enabling the DS2030 to be charged hundreds of times, therefore extending the service life well beyond 60 years.

# DS2030Y/AB Single-Piece 256kb Nonvolatile SRAM

## Pin Configuration

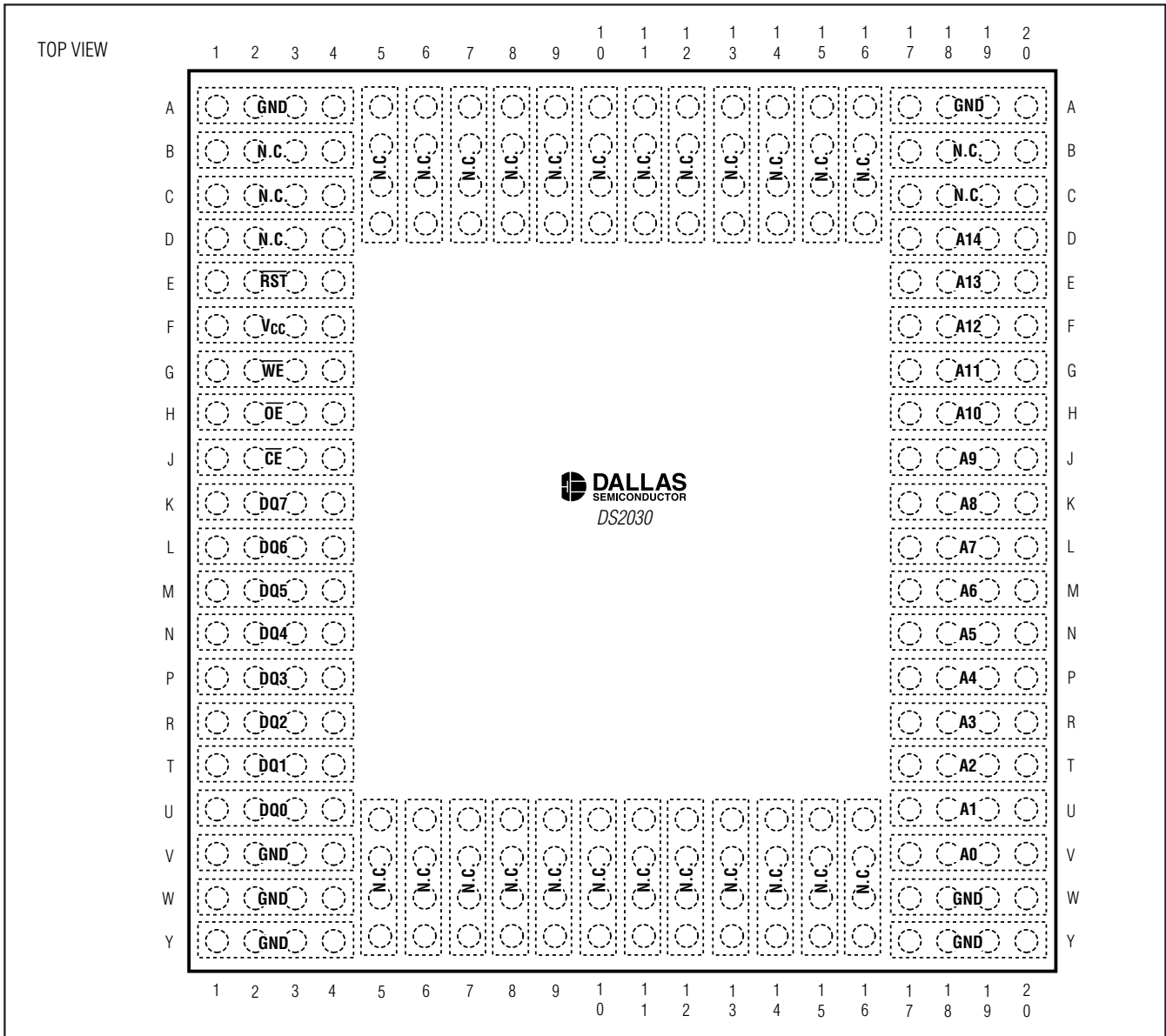

## Package Information

For the latest package outline information, go to [www.maxim-ic.com/DallasPackInfo](http://www.maxim-ic.com/DallasPackInfo).

Maxim cannot assume responsibility for use of any circuitry other than circuitry entirely embodied in a Maxim product. No circuit patent licenses are implied. Maxim reserves the right to change the circuitry and specifications without notice at any time.

12 Maxim Integrated Products, 120 San Gabriel Drive, Sunnyvale, CA 94086 408-737-7600

© 2005 Maxim Integrated Products Printed USA MAXIM is a registered trademark of Maxim Integrated Products.

DALLAS SEMICONDUCTOR is a registered trademark of Dallas Semiconductor Corporation.