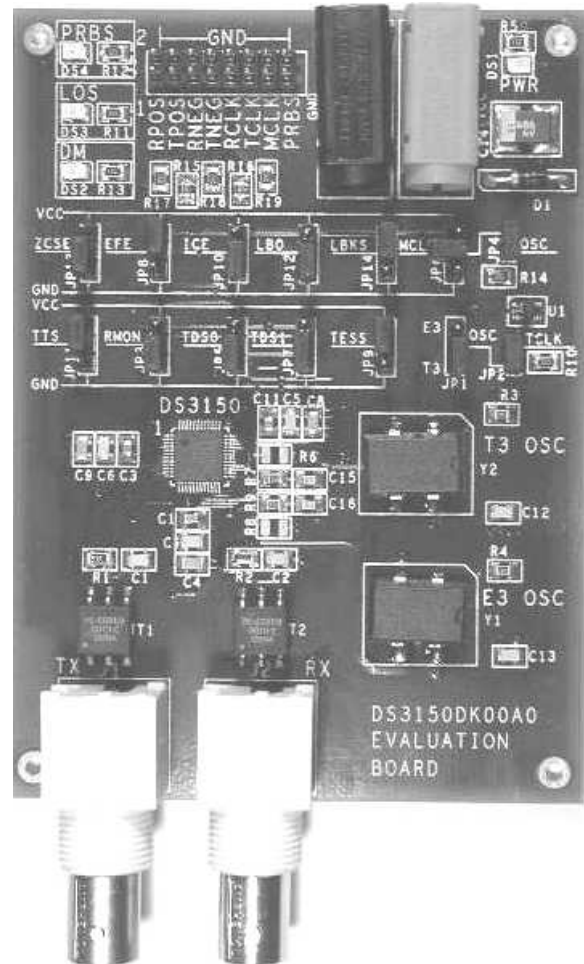


### FEATURES

- Small size: approximately 3" x 4"
- Soldered-down DS3150 in 48-pin TQFP package for best signal integrity
- Line-side BNC connectors for Tx+/Tx- and Rx+/Rx- differential pairs
- High-frequency 2:1 transformers on the transmit and receive differential pairs
- Carefully designed layout for all analog signal paths
- System-side connector for TCLK/TPOS/TNEG, RCLK/RPOS/RNEG, MCLK, and PRBS supports external data source/sink
- Jumpers to control EFE, ICE, LBKS\*, LBO, RMON, TDS0, TDS1/OFSEL, TESS, TTS,\* and ZCSE\*
- Jumpers to connect TCLK to DS3 oscillator, E3 oscillator or connector pin
- Jumpers to connect MCLK to DS3 oscillator, E3 oscillator, connector pin, V<sub>CC</sub>, or ground
- LEDs for DM\* (red), LOS\* (red), PRBS sync (green), and V<sub>DD</sub> (green)
- Banana jack connectors for V<sub>DD</sub> and GND support use of lab power supplies
- Silk-screened documentation for common hardware modes on bottom side of the board



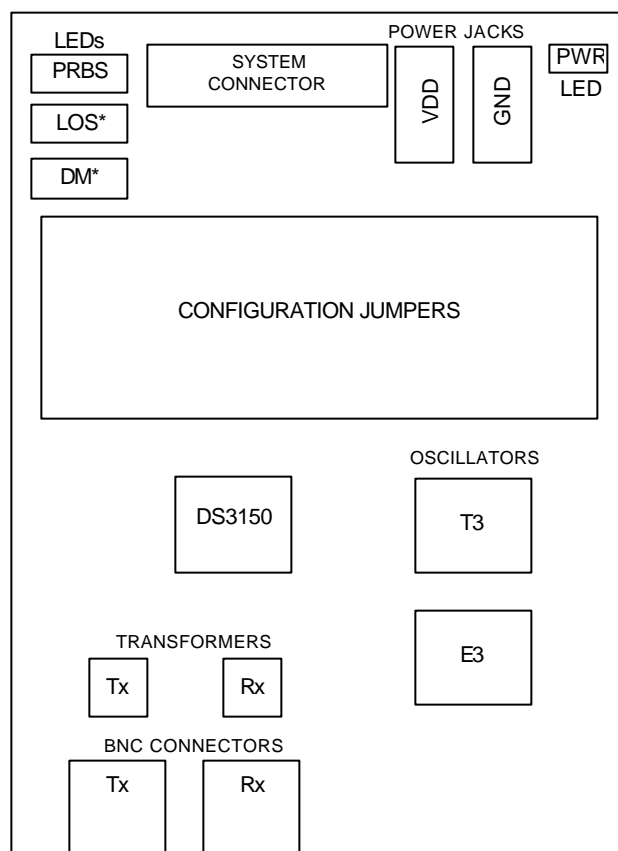
### DESCRIPTION

The DS3150DK is a small, self-contained evaluation kit for the DS3150 DS3/E3/STS-1 LIU. A soldered DS3150 and careful layout of the analog-signal traces ensure maximum signal integrity. Jumpers on the board allow the user to configure the DS3150 in any mode. LEDs indicate V<sub>CC</sub> present, loss of signal, transmit driver failure, and PRBS sync. The board provides BNC connectors for the line-side transmit and receive differential pairs and a header for various system-side signals. On-board oscillators serve as local timing sources for DS3 and E3 operation. All jumpers, LEDs, and connectors are clearly labeled to make the board as easy as possible to use.

## BOARD FLOOR PLAN

Figure 1 shows the floor plan of the DS3150DK. The DS3150 is in the center of the board. The line-side BNC connectors for the Tx and Rx differential pairs are at the bottom of the board, while the system connector and configuration jumpers are at the top. The LEDs for DM\*, LOS\*, and PRBS are in the upper left-hand corner; the power supply connectors and power indicator LED are in the upper right. The T3 and E3 oscillators sit to the right of the DS3150. All analog signal traces were carefully designed to ensure signal integrity.

**Figure 1. BOARD FLOOR PLAN**



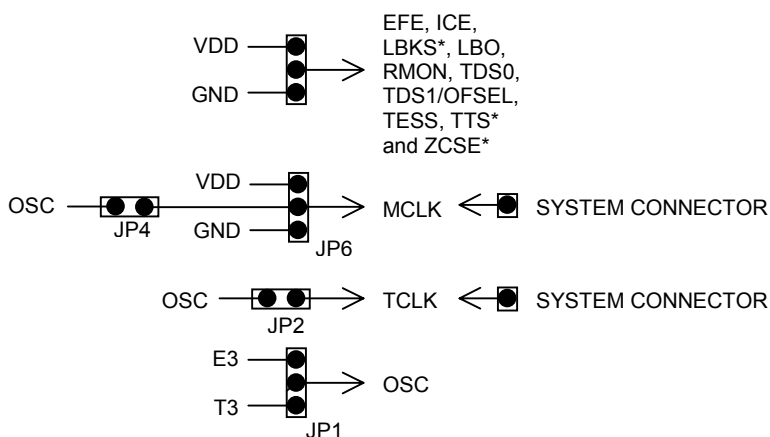
## JUMPERS

**Configuration Inputs.** The jumpers on the DS3150DK allow the user to configure the DS3150 in any of its operating modes (Figure 2). Each configuration input pin on the DS3150 has a corresponding jumper to connect the pin to  $V_{DD}$  or GND (or leave it floating). Silk-screen labels around the jumpers show that the DS3150 configuration pins are wired to the center posts of the jumper sites. Additional board markings indicate that a  $V_{CC}$  rail is connected to the top post of each jumper site while a GND rail is connected to the bottom posts. Jumpers JP3, JP5, JP7, JP8, JP9, JP10, JP11, JP12, JP13, and JP14 control configuration input pins on the DS3150.

**TCLK.** On the right side of the board, jumper JP1 connects either the T3 oscillator output or the E3 oscillator output to the intermediate node OSC. Install JP1 between top and middle posts for an E3 clock or between the middle and bottom posts for a T3 clock. Install jumper JP2 to connect the DS3150 TCLK pin to the OSC node. Leave JP2 uninstalled to source TCLK from the System Connector.

**MCLK.** Jumpers JP4 and JP6 control the DS3150 MCLK pin. Install jumper JP4 (and not JP6) to connect the DS3150 MCLK pin to the OSC node. Install jumper JP6 (and not JP4) to connect the MCLK pin to  $V_{CC}$  or GND. Leave both JP4 and JP6 uninstalled to source MCLK from the System Connector.

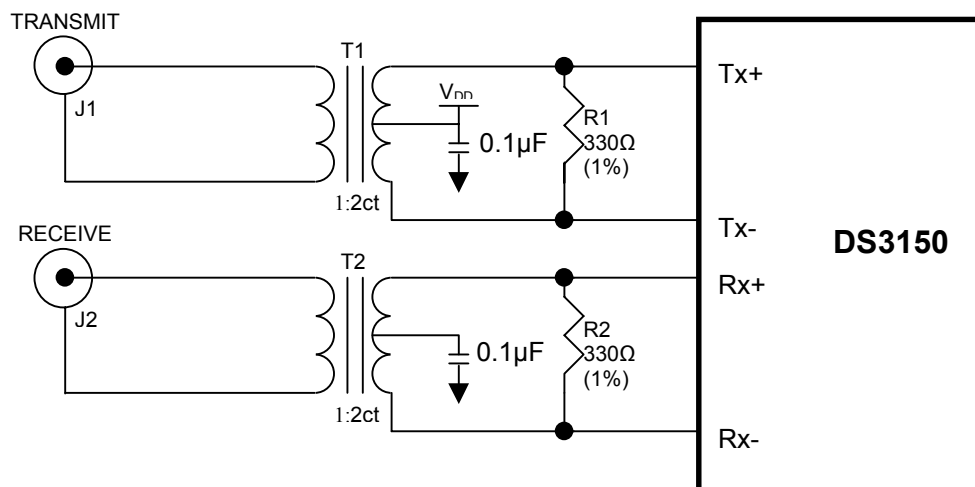
**Figure 2. DS3150DK JUMPERS**



## LINE-SIDE CONNECTIONS

The DS3150DK implements the Tx and Rx line-interface networks recommended in the DS3150 data sheet and shown in Figure 3. To connect the DS3150 to DS3, E3, or STS-1 test equipment, connect the equipment to BNC connectors J1 and J2 using coaxial cables. To externally loopback the DS3150 from transmitter to receiver, connect J1 and J2 together through a length of cable or a cable simulator.

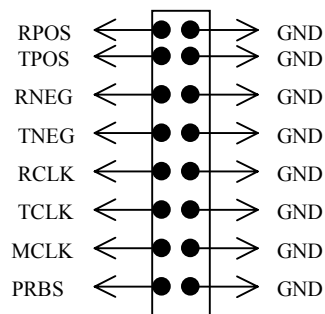
**Figure 3. DS3150DK LINE SIDE CIRCUITRY**



## SYSTEM CONNECTOR

The 16-pin System Connector at the top of the board gives access to the following DS3150 signals: RPOS, TPOS, RNEG, TNEG, RCLK, TCLK, MCLK, and PRBS. Use the System Connector to connect the DS3150 to an external framer or other data source/sink. To configure the DS3150DK board for an external remote loopback, place TCLK-RCLK, TPOS-RPOS, and TNEG-RNEG jumpers (Figure 4).

**Figure 4. SYSTEM CONNECTOR**



## POWER SUPPLY CONNECTORS

Connect a 3.3V power supply across the red ( $V_{CC}$ ) and black (GND) banana jacks. When a power supply is present, the green PWR LED is lit.

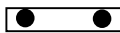
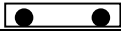
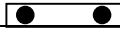



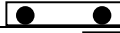
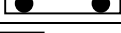
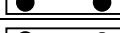
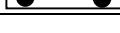
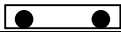
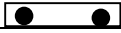
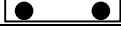
## BASIC DS3150DK CONFIGURATION

Table 1, Table 2, and Table 3 list jumper settings for basic DS3150 configurations for T3, E3, and STS-1 modes, respectively. These example configurations provide a quick start to using the DS3150DK and may not be the proper configuration for your specific application. To set up other DS3150 configurations with the DS3150DK, refer to the DS3150 data sheet for more details about configuration pins and options.

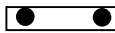
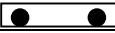
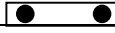


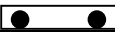
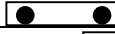
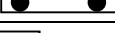
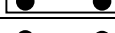
**Table 1. BASIC T3 CONFIGURATION**

SIGNAL NAME	JUMPER POSITION		JUMPER	ACTION
	GND	V <sub>CC</sub>		
ZCSE*	<input checked="" type="checkbox"/>	<input checked="" type="checkbox"/>	JP13	B3ZS encoder/decoder enabled
EFE	<input type="checkbox"/>	<input checked="" type="checkbox"/>	JP8	Enhanced features enabled
ICE	<input checked="" type="checkbox"/>	<input checked="" type="checkbox"/>	JP10	Normal RCLK, normal TCLK
LBO	<input checked="" type="checkbox"/>	<input checked="" type="checkbox"/>	JP12	Cable > 225ft
LBKS*	<input type="checkbox"/>	<input checked="" type="checkbox"/>	JP14	No loopback enabled
MCLK	<input type="checkbox"/>	<input type="checkbox"/>	JP6	Don't wire MCLK high or low
TTS*	<input type="checkbox"/>	<input checked="" type="checkbox"/>	JP11	Enable transmit driver
RMON	<input checked="" type="checkbox"/>	<input checked="" type="checkbox"/>	JP3	Disable 20dB preamp
TDS0	<input checked="" type="checkbox"/>	<input checked="" type="checkbox"/>	JP5	Transmit T3 AIS pattern
TDS1	<input type="checkbox"/>	<input checked="" type="checkbox"/>	JP7	
TESS	<input type="checkbox"/>	<input checked="" type="checkbox"/>	JP9	T3 mode
<b>SIGNAL NAME</b>				
SIGNAL NAME	JUMPER POSITION		JUMPER	ACTION
	T3	E3		
TCLK	<input checked="" type="checkbox"/>	<input checked="" type="checkbox"/>	JP2	Source TCLK from OSC node
MCLK	<input checked="" type="checkbox"/>	<input checked="" type="checkbox"/>	JP4	Source MCLK from OSC node
<b>SIGNAL NAME</b>				
SIGNAL NAME	JUMPER POSITION		JUMPER	ACTION
	T3	E3		
OSC	<input checked="" type="checkbox"/>	<input checked="" type="checkbox"/>	JP1	Source OSC from T3 oscillator

**Table 2. BASIC E3 CONFIGURATION**

SIGNAL NAME	JUMPER POSITION		JUMPER	ACTION
	GND	V <sub>CC</sub>		
ZCSE*		●	JP13	HDB3 encoder/decoder enabled
EFE	●		JP8	Enhanced features enabled
ICE		●	JP10	Normal RCLK, normal TCLK
LBO		●	JP12	Cable > 225ft
LBKS*	●		JP14	No loopback enabled
MCLK	●	●	JP6	Don't wire MCLK high or low
TTS*	●		JP11	Enable transmit driver
RMON		●	JP3	Disable 20dB preamp
TDS0	●		JP5	Transmit unframed all 1's (E3 AIS)
TDS1		●	JP7	
TESS		●	JP9	E3 mode
SIGNAL NAME	JUMPER POSITION		JUMPER	ACTION
TCLK			JP2	Source TCLK from OSC node
MCLK			JP4	Source MCLK from OSC node
SIGNAL NAME	JUMPER POSITION		JUMPER	ACTION
	T3	E3		
OSC	●		JP1	Source OSC from E3 oscillator

**Table 3. BASIC STS-1 CONFIGURATION**

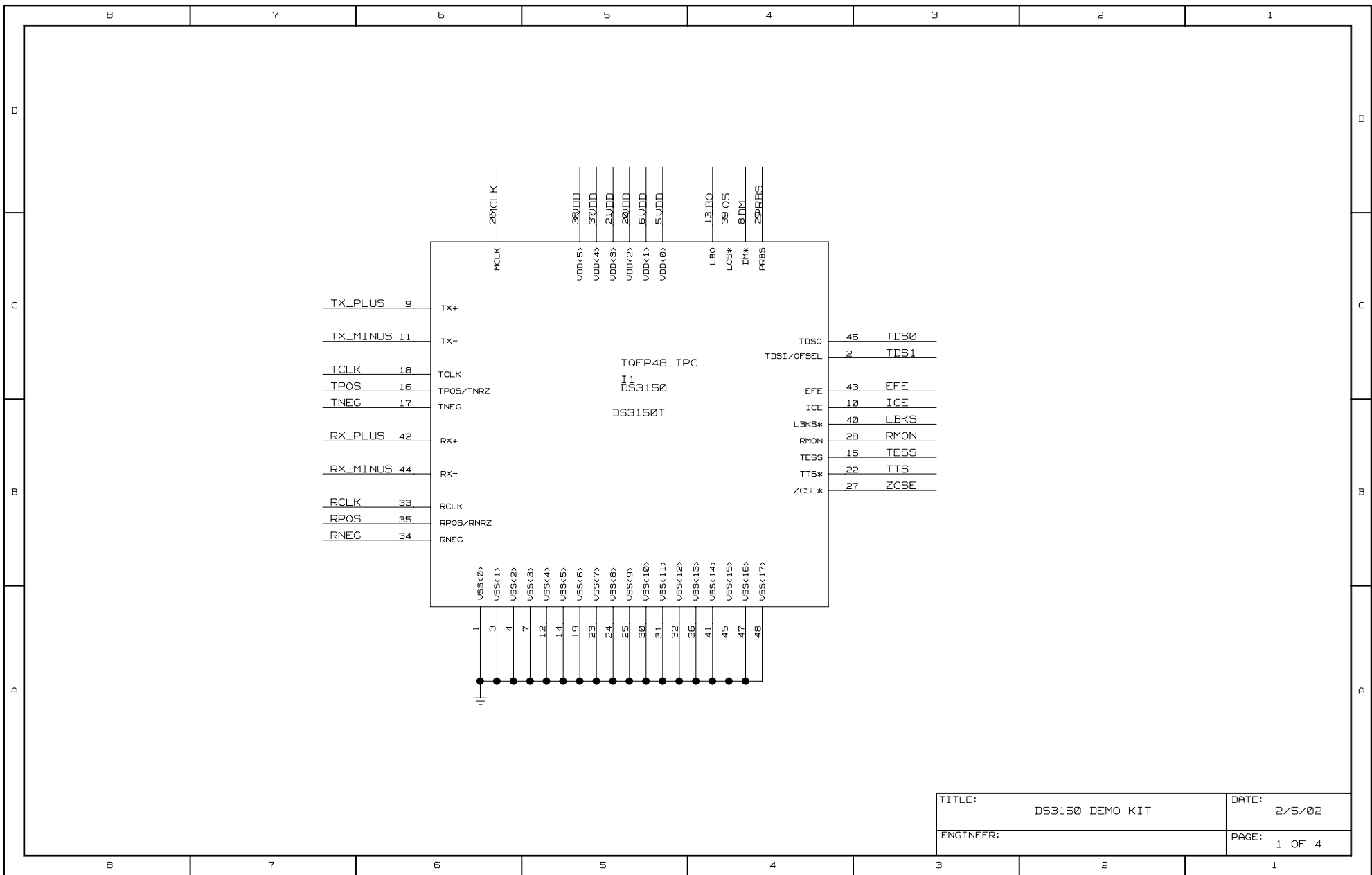
SIGNAL NAME	JUMPER POSITION		JUMPER	ACTION
	GND	V <sub>CC</sub>		
ZCSE*		●	JP13	B3ZS encoder/decoder enabled
EFE	●		JP8	Enhanced features enabled
ICE		●	JP10	Normal RCLK, normal TCLK
LBO		●	JP12	Cable > 225ft
LBKS*	●		JP14	No loopback enabled
MCLK	●	●	JP6	Don't wire MCLK high or low
TTS*	●		JP11	Enable transmit driver
RMON		●	JP3	Disable 20dB preamp
TDS0	●		JP5	Transmit unframed all ones
TDS1		●	JP7	
TESS	●	●	JP9	Float = STS-1 mode
<b>SIGNAL NAME</b>				
SIGNAL NAME	JUMPER POSITION		JUMPER	ACTION
	T3	E3		
TCLK	●	●	JP2	Not Installed = Source TCLK from System Connector <sup>1</sup>
MCLK	●	●	JP4	Not Installed = Source MCLK from System Connector <sup>1</sup>
<b>SIGNAL NAME</b>				
SIGNAL NAME	JUMPER POSITION		JUMPER	ACTION
	T3	E3		
OSC	●	●	JP1	Not installed = Don't select T3 or E3 oscillator <sup>1</sup>

<sup>1</sup>The DS3150 does not have an on-board STS-1 oscillator. Apply a transmission-quality STS-1 clock to the TCLK pin on the System Connector.

**BILL OF MATERIALS****Table 4. BILL OF MATERIALS**

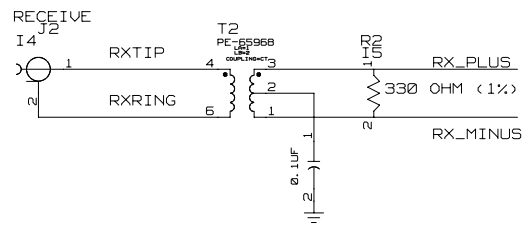
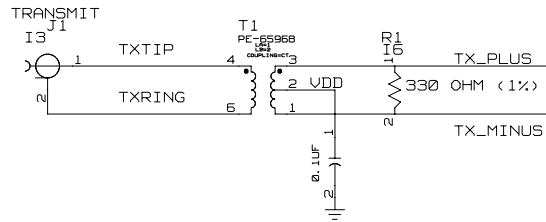
ITEM	DESCRIPTION	MANUFACTURER PART NUMBER	MANUFACTURER	QTY	ADDITIONAL INFORMATION	REF DESIGNATOR
1	3.3V Oscillator	CPPX7-A5BC	Cardinal Components	1	44.736MHz Frequency	Y2
2	3.3V Oscillator	CPPX7-A5BC	Cardinal Components	1	34.368MHz Frequency	Y1
3	T3/E3 SMD Transformer	PE-65968	Pulse	2		T1, T2
4	Green SMD LED	LN1351C-(TR)	Panasonic	2		DS1, DS4
5	Red SMD LED	LN1251C-(TR)	Panasonic	2		DS2, DS3
6	DS3150 TQFP48	DS3150T	Dallas Semiconductor	1		DS3150
7	MAX6316L	MAX6316LUK26CY-T	Maxim Integrated Products	1		U1
8	BNC CONN			2		J1, J2
9	Red Banana Jack	1646219	Mouser	1		VCC
10	Black Banana Jack	1646218	Mouser	1		GND
11	SMD 330Ω			3	Precision (1%)	R1, R2, R5
12	SMD 68μF Cap			1		C14
13	SMD 350Ω			2		R11, R13
14	SMD 100Ω			2		R7, R9
15	SMD 35Ω			5		R10, R14, R17, R18, R19
16	SMD 300Ω			1		R12
17	SMD 10kΩ			4		R3, R4, R15, R16
18	Protection Diode	IN4001		1		D1
19	Jumper 3-Pin			12		JP1, JP3, JP5, JP6, JP7, JP8, JP9, JP10, JP11, JP12, JP13, JP14
20	Jumper 2-Pin			2		JP2, JP4
21	SMD 1μF CAP			3		C9, C10, C11
22	SMD 0.1μF CAP			7		C1, C2, C6, C7, C8, C12, C13
23	SMD 0.01μF CAP			3		C3, C4, C5
24	SMD 0.001μF CAP			2		C15, C16
25	Mounting Connectors			4		I11, I12, I13, I14
26	16-Pin Header			1		J3





TITLE:	DS3150 DEMO KIT	DATE:	2/5/02
ENGINEER:		PAGE:	1 OF 4

NETWORK INTERFACE

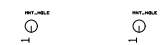


MOUNTING HOLES

MNT\_HOLE1 MNT\_HOLE4  
I11 I12

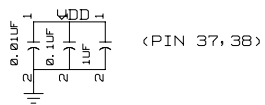
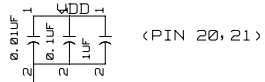
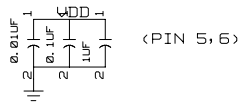


MNT\_HOLE2 MNT\_HOLE3  
I13 I14

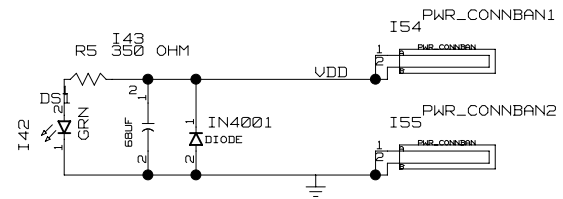


TITLE:	DS3150 DEMO KIT	DATE:	2/5/02
ENGINEER:		PAGE:	2 OF 4

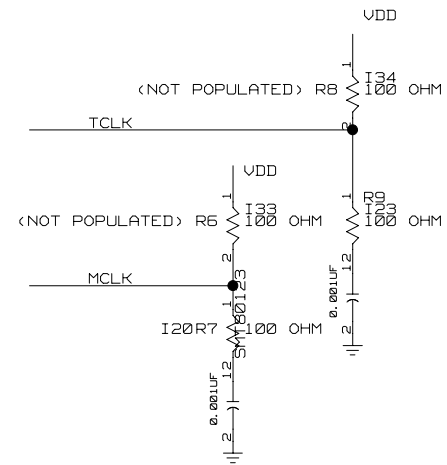
DECOUPLING CAPS



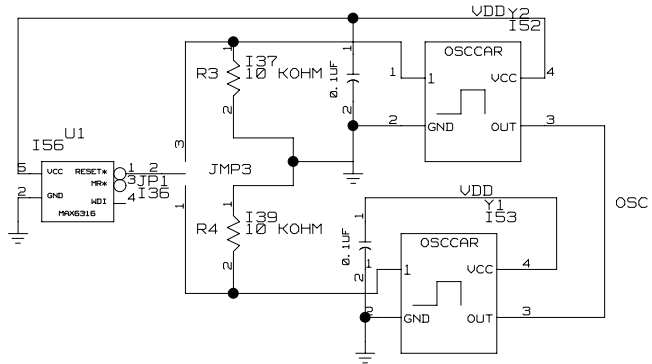
POWER CONNECTORS



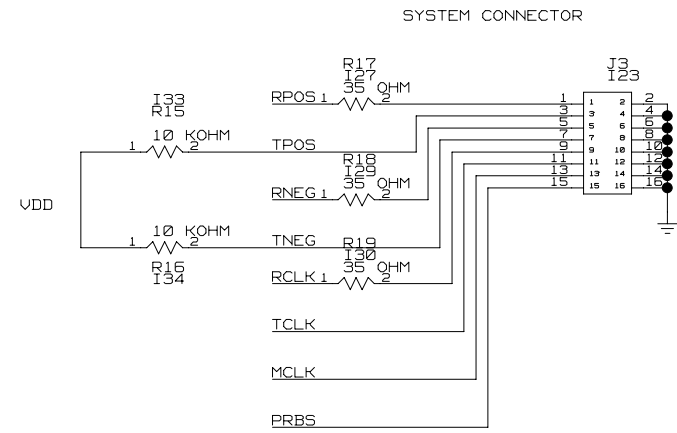
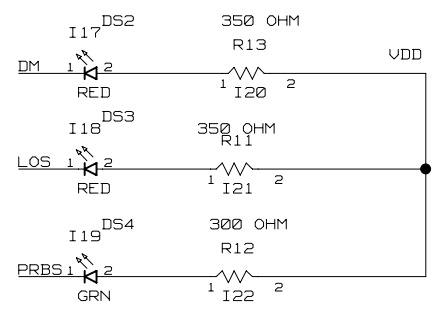
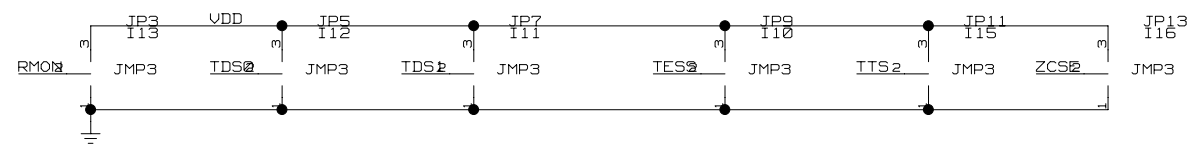
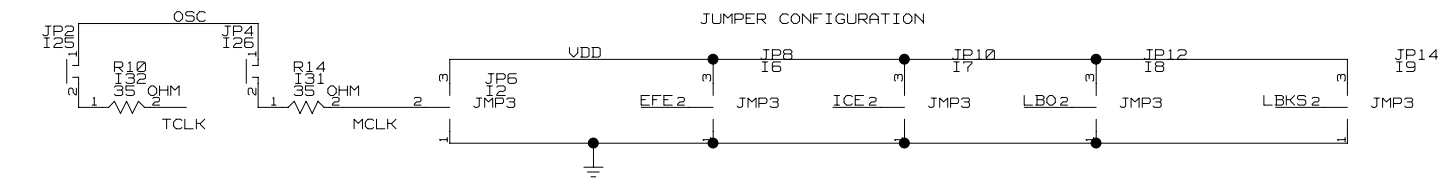
INPUT TERMINATION



T3 E1 OSCILLATOR SELECT



TITLE:	DS3150 DEMO KIT	DATE:	2/5/02
ENGINEER:		PAGE:	3 OF 4



TITLE:	DS3150 DEMO KIT	DATE:	2/5/02
ENGINEER:		PAGE:	4 OF 4