

SANYO	No.725F	LA7800
Color TV Synchronization, Deflection Circuit		

The LA7800 is a multifunctional IC containing various required for synchronization; deflection of color television sets. This IC has been developed under the design concept that the basic characteristics should be made more complete and the television sets with this IC incorporated should be streamlined by making the device compact (DIP-16) and by minimizing the number of parts required.

Functions

- Synchronizing separation
- Vertical oscillation
- Vertical blanking
- Horizontal AFC
- Vertical drive
- Horizontal oscillation
- X-ray protection

Features

- Multifunction and compact(DIP-16)
- Minimum number of parts required
- Horizontal, vertical oscillators are stable against variations in ambient temperature and supply voltage due to small warm-up drift.
- Small variation in horizontal oscillation frequency
- Good linearity and interlace because DC bias at vertical output stage is subjected to sampling control within retrace time.
- Vertical blanking pulse width can be set freely according to peripheral parts.

Maximum Ratings at Ta=25°C

Maximum Supply Voltage	V ₁₂	14	V	unit
Maximum Supply Current	I ₁₅	16	mA	
Allowable Power Dissipation	P _{d max}	450	mW	
Operating Temperature	T _{opr}	-20 to +85	°C	
Storage Temperature	T _{stg}	-55 to +125	°C	

Recommended Operating Condition at Ta=25°C

Recommended Supply Voltage	V ₁₂	12	V	unit
----------------------------	-----------------	----	---	------

Operating Characteristics at Ta=25°C, V₁₂=12V, I_{CC15}=13mA

		min	typ	max	unit
V _{CC12} Current Dissipation	I _{CC12}	13.0		20.0	mA
V _{CC15} Supply Voltage	V _{CC15}	11.8		13.2	V
Vertical Frequency Pull-In Range		9.0		11.0	Hz
Vertical Free-Running Frequency	f _v	f _{v center} 55Hz	50	60	Hz
Supply Voltage Dependence of Vertical Frequency	V ₁₂ =12±1V, 55Hz at 12V	-0.5		0.5	Hz

Ta = -10 to +60°C -0.028 0.028 Hz/°C
Continued on next page.

Package Dimensions

(unit :mm)
3006B

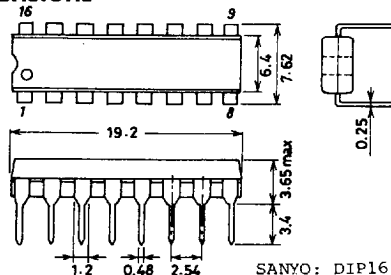

SANYO: DIP16

SANYO Electric Co., Ltd. Semiconductor Business Headquarters

TOKYO OFFICE Tokyo Bldg., 1-10, 1 Chome, Ueno, Taito-ku, TOKYO, 110 JAPAN

182 ■ 7997076 0019103 764 ■ N298YT / 8215KI / 3214KI / 6023KI, TS №725-1/3

LA7800

Continued from preceding page.

Vertical Driver Amplification Factor

Horizontal Free-Running Frequency f_H

Supply Voltage Dependence of Horizontal Frequency

Temperature Characteristic of Horizontal Frequency

Horizontal Output Pulse Width

Horizontal Output Drive Current

f_H center 15.734kHz
 $V_Z - V_Z \times 90\%$

$T_a = -10$ to $+60^\circ\text{C}$

$f_H = 15.734\text{kHz}$

	min	typ	max	unit
Vertical Driver Amplification Factor	4.0		7.0	deg
Horizontal Free-Running Frequency f_H	-750		750	Hz
Supply Voltage Dependence of Horizontal Frequency	-50		50	Hz
Temperature Characteristic of Horizontal Frequency	-3.4		3.4	Hz/°C
Horizontal Output Pulse Width	21.5		26.5	μs
Horizontal Output Drive Current	3.8		7.2	mA

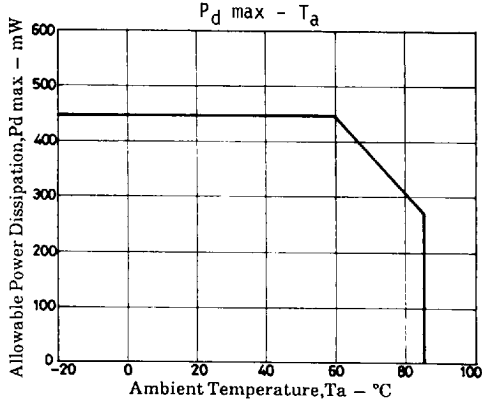

Sample Application Circuit

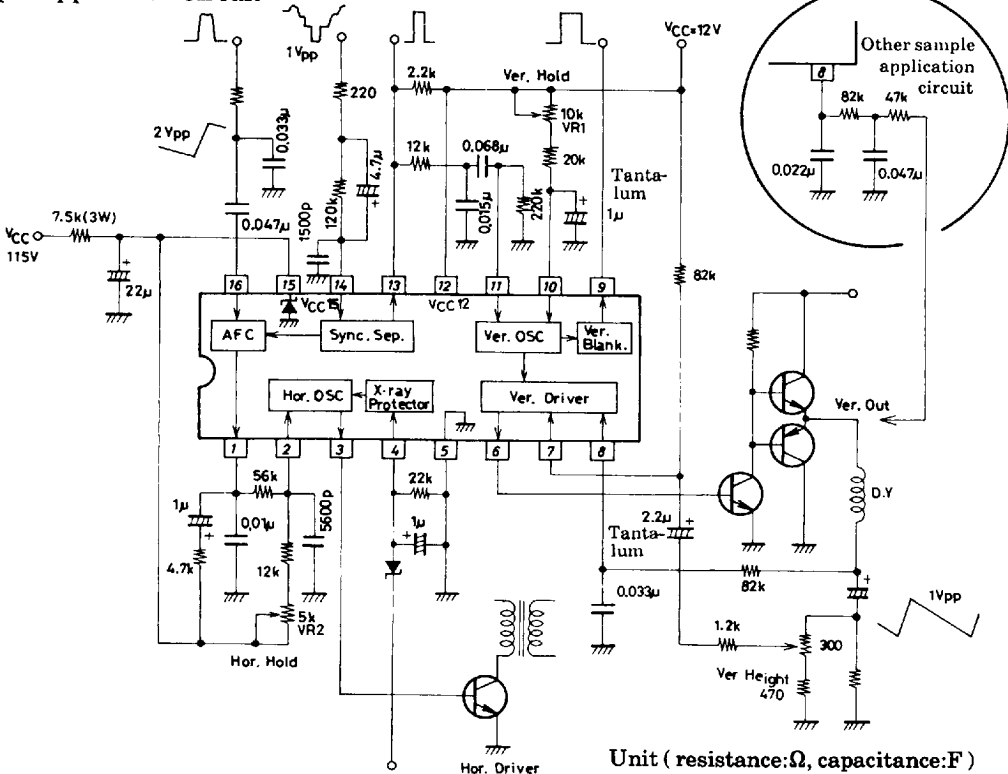

- Note) 1. The vertical output circuit is represented by the basic circuit.
 2. The peripheral parts connected to pin 8 are changed according to the Ver.Out circuit conditions.
 3. The limit resistor (220 Ω ; 1Vp-p) connected to pin 14 is changed according to the magnitude of the input video signal.
 4. The time constant circuit (120k Ω , 4.7 μF) connected to pin 14 is such that the resistor is changed according to the DC level of the input video signal and the time constant is changed with the capacitance value.

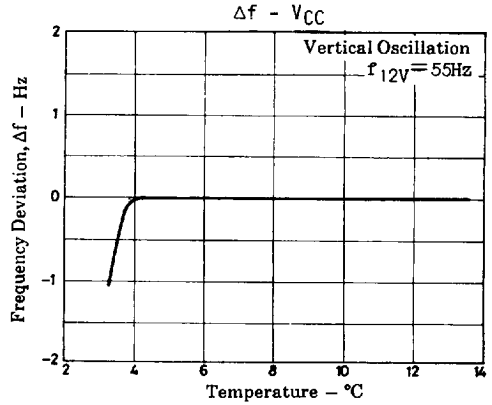
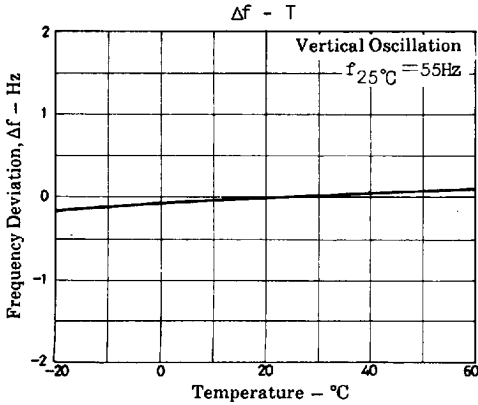
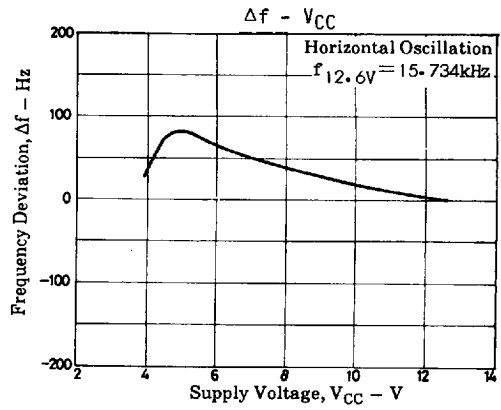
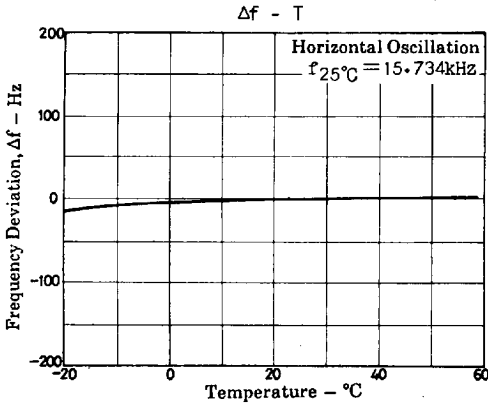

Note) The Temperature characteristic of oscillation frequency represents the one for IC itself without peripheral parts.