



# LC75410E, 75410W

## Electronic Volume Controller for Car Audio Systems



### Overview

The LC75410E and 75410W are electronic volume controllers that enable control of volume, balance, fader, bass/treble/mid, loudness, input switching, and input gain using only a small number of external components.

### Functions

- Volume: 0 dB to  $-79.5$  dB in 0.5-dB steps, and  $-\infty$  (161 positions) Balance function with separate L/R control
- Fader: rear output or front output can be attenuated across 16 positions (in 1-dB steps from 0 dB to  $-2$  dB, 2-dB steps from  $-2$  dB to  $-20$  dB, 10-dB steps from  $-20$  dB to  $-30$  dB, and  $-45$  dB,  $-60$  dB,  $-\infty$ )
- Bass/treble/mid: Each band can be controlled in 1-dB steps from 0 dB to  $\pm 6$  dB, and in 2-dB steps from  $\pm 8$  dB to  $\pm 12$  dB.
- Input gain: 0 dB to  $+18.75$  dB (1.25-dB steps) amplification is possible for the input signal.
- Input switching: five input signals can be selected for Left and for Right (Four are single-ended inputs and one is a differential input.)
- Loudness: A tap is output from the  $-32$  dB position of a 2 dB step volume control resistor ladder. A loudness function can be implemented by connecting an external RC circuit.

### Features

- On-chip buffer amplifier cuts down number of external components
- Low switching noise generated by on-chip switch through use of silicon gate CMOS process, for low switching noise when there is no signal
- Low switching noise when there is a signal due to use of on-chip zero-cross switching circuit
- On-chip 1/2 VDD reference voltage circuit
- Controls performed with serial input (CCB)

- CCB is a trademark of SANYO ELECTRIC CO., LTD.
- CCB is SANYO's original bus format and all the bus addresses are controlled by SANYO.

- Any and all SANYO products described or contained herein do not have specifications that can handle applications that require extremely high levels of reliability, such as life-support systems, aircraft's control systems, or other applications whose failure can be reasonably expected to result in serious physical and/or material damage. Consult with your SANYO representative nearest you before using any SANYO products described or contained herein in such applications.
- SANYO assumes no responsibility for equipment failures that result from using products at values that exceed, even momentarily, rated values (such as maximum ratings, operating condition ranges, or other parameters) listed in products specifications of any and all SANYO products described or contained herein.

**SANYO Electric Co.,Ltd. Semiconductor Company**

TOKYO OFFICE Tokyo Bldg., 1-10, 1 Chome, Ueno, Taito-ku, TOKYO, 110-8534 JAPAN

### Package Dimensions

unit: mm

3159-QIP64E

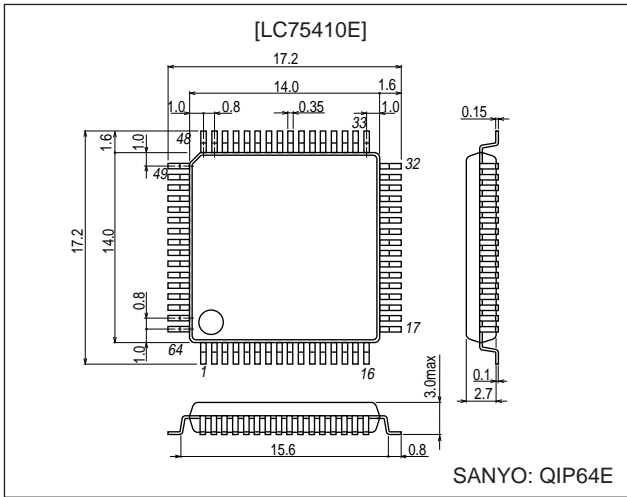

unit: mm

3190-SQFP64

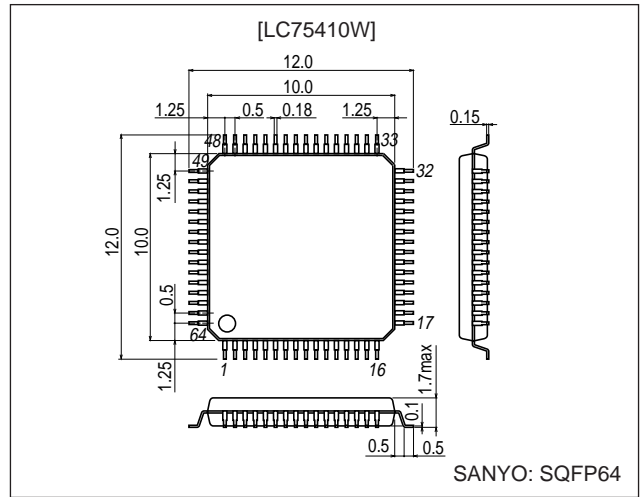

### Pin Assignment

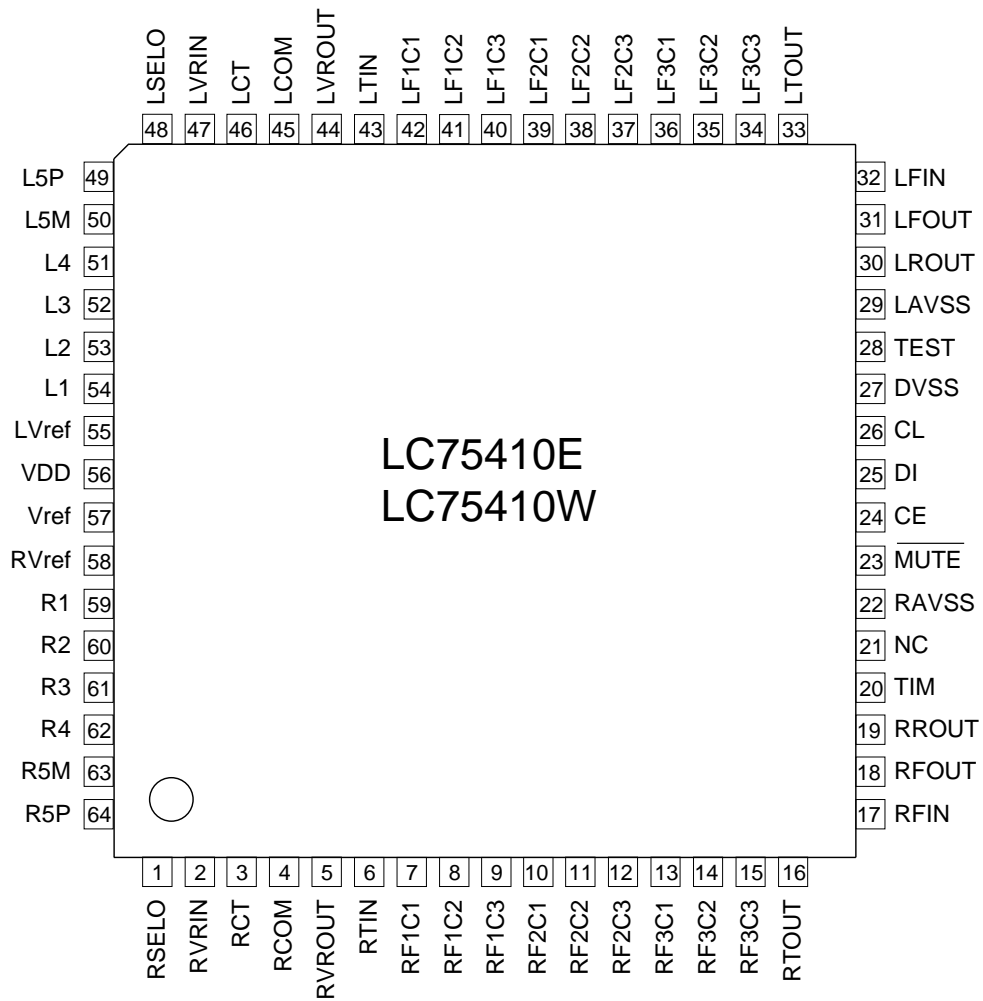

Equivalent Circuit Block Diagram/Sample Application Circuit

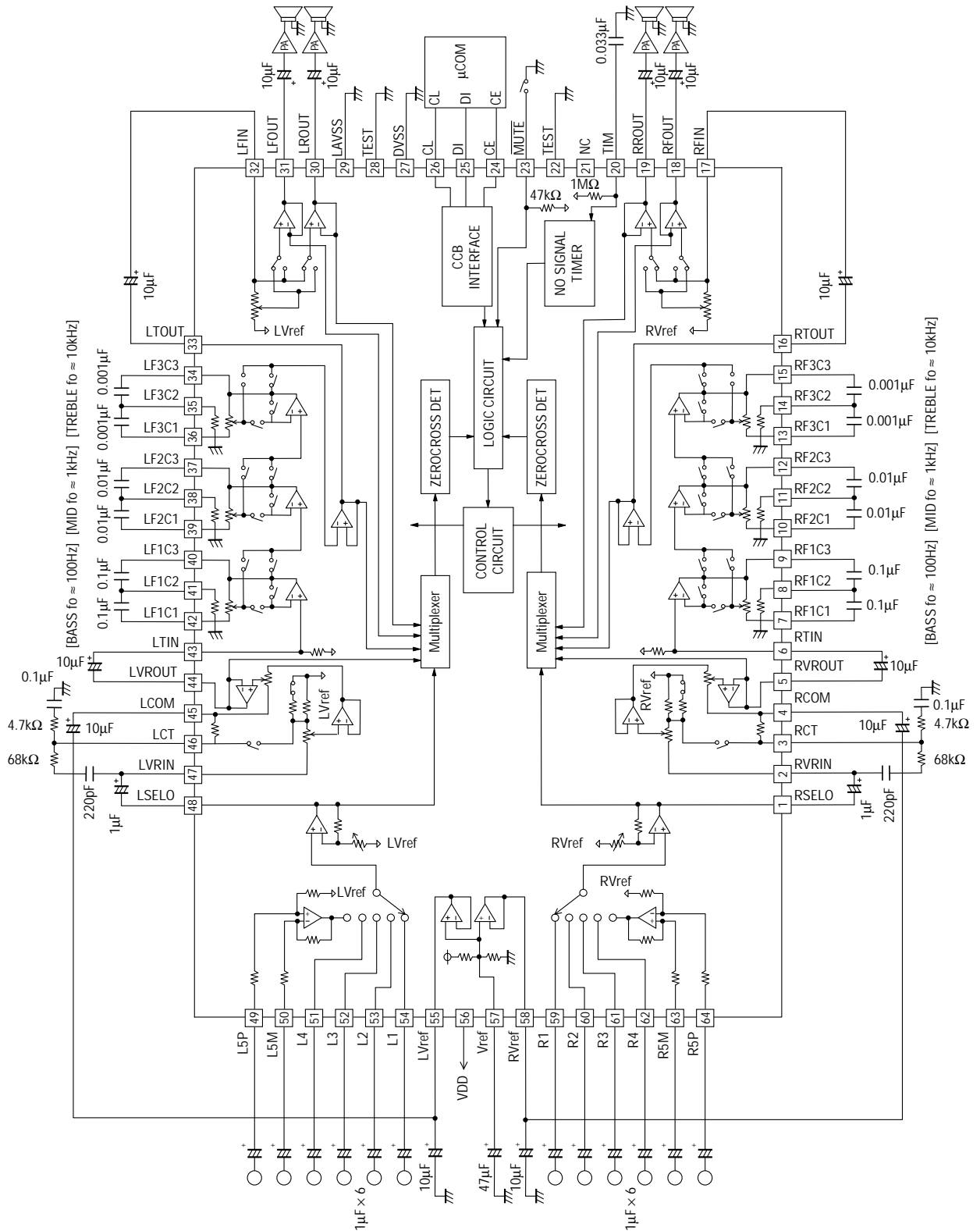

## LC75410E, 75410W

### Specifications

#### Absolute Maximum Ratings at $T_a = 25^\circ\text{C}$ , $V_{SS} = 0\text{ V}$

| Parameter                   | Symbol              | Conditions  | Ratings                          | Unit             |    |
|-----------------------------|---------------------|---|----------------------------------|------------------|----|
| Maximum supply voltage      | $V_{DD\text{ max}}$ | $V_{DD}$  | 11                               | V                |    |
| Maximum input voltage       | $V_{IN\text{ max}}$ | All input pins                                      | $V_{SS} - 0.3$ to $V_{DD} + 0.3$ | V                |    |
| Allowable power dissipation | $Pd\text{ max}$     | $T_a \leq 85^\circ\text{C}$ , when mounted on board | QIP64E                           | 680              | mW |
|                             |                     |   | SQFP64                           | 800              |    |
| Operating temperature       | $T_{opr}$           |   | -40 to +85                       | $^\circ\text{C}$ |    |
| Storage temperature         | $T_{stg}$           |   | -50 to +125                      | $^\circ\text{C}$ |    |

#### Allowable Operating Ranges at $T_a = 25^\circ\text{C}$ , $V_{SS} = 0\text{ V}$

| Parameter                | Symbol       | Conditions       | Ratings  |     |          | Unit          |
|--------------------------|--------------|------------------|----------|-----|----------|---------------|
|                          |              |                  | min      | typ | max      |               |
| Supply voltage           | $V_{DD}$     | $V_{DD}$         | 6.0      |     | 10.5     | V             |
| Input high-level voltage | $V_{IH}$     | CL, DI, CE, MUTE | 4.0      |     | 10.5     | V             |
| Input low-level voltage  | $V_{IL}$     | CL, DI, CE, MUTE | $V_{SS}$ |     | 1.0      | V             |
| Input amplitude voltage  | $V_{IN}$     |                  | $V_{SS}$ |     | $V_{DD}$ | Vp-p          |
| Input pulse width        | $T_{\phi W}$ | CL               | 1        |     |          | $\mu\text{s}$ |
| Setup time               | $T_{setup}$  | CL, DI, CE       | 1        |     |          | $\mu\text{s}$ |
| Hold time                | $T_{hold}$   | CL, DI, CE       | 1        |     |          | $\mu\text{s}$ |
| Operating frequency      | fopg         | CL               |          |     | 500      | kHz           |

#### Electrical Characteristics at $T_a = 25^\circ\text{C}$ , $V_{DD} = 9\text{ V}$ , $V_{SS} = 0\text{ V}$

| Parameter            | Symbol      | Pin Name                   | Conditions     | Ratings |          |           | Unit             |
|----------------------|-------------|----------------------------|----------------|---------|----------|-----------|------------------|
|                      |             |                            |                | min     | typ      | max       |                  |
| [Input block]        |             |                            |                |         |          |           |                  |
| Input resistance     | $R_{in}$    | L1 to L4, R1 to R4         |                | 25      | 50       | 100       | $\text{k}\Omega$ |
| Minimum input gain   | $G_{inmin}$ | L1 to L4, R1 to R4         |                | -1      | 0        | +1        | dB               |
| Maximum input gain   | $G_{inmax}$ |                            |                | +16.5   | +18.75   | +21       | dB               |
| Step setting error   | $A_{Terr}$  |                            |                |         |          | $\pm 0.5$ | dB               |
| L/R balance          | BAL         |                            |                |         |          | $\pm 0.5$ | dB               |
| [Volume Block]       |             |                            |                |         |          |           |                  |
| Input resistance     | $R_{vr}$    | LVRIN, RVRIN, loudness off |                | 113     | 226      | 452       | $\text{k}\Omega$ |
| Step setting error   | $A_{Terr}$  |                            |                |         |          | $\pm 0.5$ | dB               |
| L/R balance          | BAL         |                            |                |         |          | $\pm 0.5$ | dB               |
| [Tone block]         |             |                            |                |         |          |           |                  |
| Step setting error   | $A_{Terr}$  |                            |                |         |          | $\pm 1.0$ | dB               |
| Bass control range   | $G_{bass}$  |                            | max. boost/cut | $\pm 9$ | $\pm 12$ | $\pm 15$  | dB               |
| Mid control range    | $G_{mid}$   |                            | max. boost/cut | $\pm 9$ | $\pm 12$ | $\pm 15$  | dB               |
| Treble control range | $G_{tre}$   |                            | max. boost/cut | $\pm 9$ | $\pm 12$ | $\pm 15$  | dB               |
| L/R balance          | BAL         |                            |                |         |          | $\pm 0.5$ | dB               |

Continued on next page.

## LC75410E, 75410W

Continued from preceding page.

| Parameter                   | Symbol                | Pin Name  | Conditions     | Ratings |       |      | Unit |
|-----------------------------|-----------------------|---|----------------|---------|-------|------|------|
|                             |                       |   |                | min     | typ   | max  |      |
| <b>[Fader Block]</b>        |                       |   |                |         |       |      |      |
| Input resistance            | R <sub>fed</sub>      | LFIN, RFIN  |                | 25      | 50    | 100  | kΩ   |
| Step setting error          | ATerr                 |   | 0dB to -2dB    |         |       | ±0.5 | dB   |
|                             |                       |   | -2dB to -20dB  |         |       | ±1   | dB   |
|                             |                       |   | -20dB to -30dB |         |       | ±2   | dB   |
|                             |                       |   | -30dB to -60dB |         |       | ±3   | dB   |
| L/R balance                 | BAL                   |   |                |         |       | ±0.5 | dB   |
| <b>[General]</b>            |                       |   |                |         |       |      |      |
| Total harmonic distortion   | THD (1)               | V <sub>IN</sub> = 0dBV, f = 1 kHz   |                |         | 0.004 | 0.01 | %    |
|                             | THD (2)               | V <sub>IN</sub> = -10dBV, f = 10 kHz                                      |                |         | 0.006 | 0.01 | %    |
| Input crosstalk             | CT                    | V <sub>IN</sub> = 1Vrms, f = 1 kHz  |                | 80      | 88    |      | dB   |
| L/R crosstalk               | CT                    | V <sub>IN</sub> = 1Vrms, f = 1 kHz  |                | 80      | 88    |      | dB   |
| Maximum attenuated output   | V <sub>omin</sub> (1) | V <sub>IN</sub> = 1Vrms, f = 1 kHz  |                | 80      | 88    |      | dB   |
|                             | V <sub>omin</sub> (2) | V <sub>IN</sub> = 1Vrms, f = 1 kHz<br>INMUTE, fader →∞                    |                | 90      | 95    |      | dB   |
| Output noise voltage        | V <sub>N</sub> (1)    | Flat overall, IHF-A filter  |                |         | 5     | 10   | μV   |
|                             | V <sub>N</sub> (2)    | Flat overall, 20 to 20 kHzBPF   |                |         | 7     | 15   | μV   |
| Current drain               | I <sub>DD</sub>       |   |                |         | 40    | 45   | mA   |
| Input high-level current    | I <sub>IH</sub>       | CL, DI, CE, V <sub>IN</sub> = 9 V   |                |         |       | 10   | μA   |
| Input low-level current     | I <sub>IL</sub>       | CL, DI, CE, V <sub>IN</sub> = 0 V   |                | -10     |       |      | μA   |
| Maximum input voltage       | V <sub>CL</sub>       | THD = 1%, R <sub>L</sub> = 10 kΩ<br>flat overall, f <sub>IN</sub> = 1 kHz |                | 2.3     | 2.8   |      | Vrms |
| Common-mode rejection ratio | CMRR                  | V <sub>IN</sub> = 0 dB, f = 1 kHz   |                | 45      | 70    |      | dB   |

### Control Timing and Data Format

To control the LC75410E and LC75410W input specified serial data to the CE, CL, and DI pins.  
The data configuration consists of a total of 52 bits broken down into 8 address bits and 44 data bits.

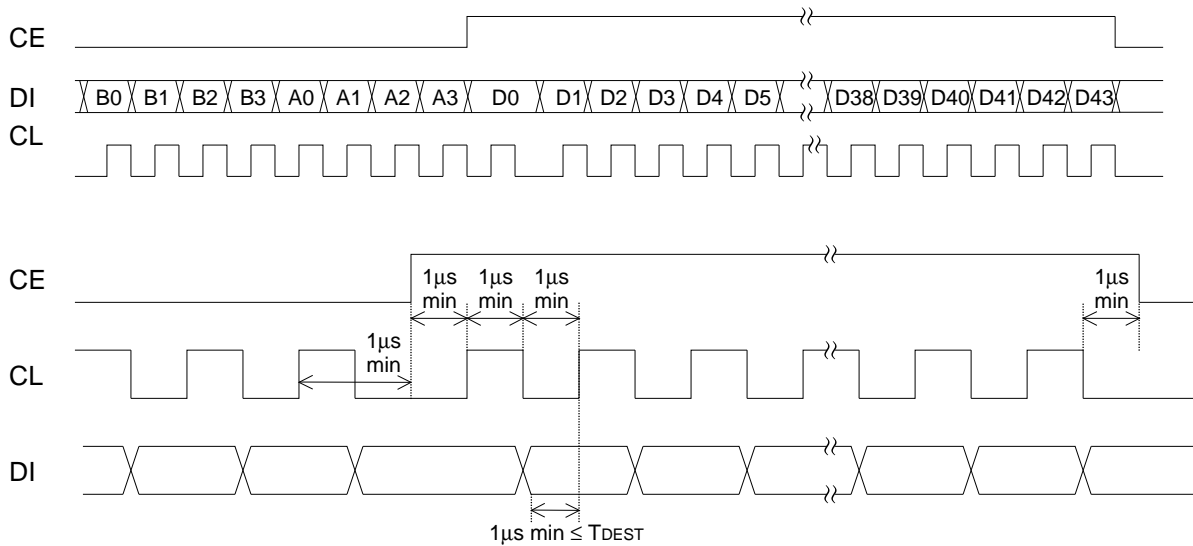

## LC75410E, 75410W

### Address code (B0 to A3)

The LC75410E and 75410W use 8-bit address code and can be used in common with ICs that support SANYO's CCB serial bus.

#### Address Code

|       |    |    |    |    |    |    |    |    |         |
|-------|----|----|----|----|----|----|----|----|---------|
| (LSB) | B0 | B1 | B2 | B3 | A0 | A1 | A2 | A3 | (81HEX) |
|       | 1  | 0  | 0  | 0  | 0  | 0  | 0  | 1  |         |

### Control code allocation

#### Input Switching Control

| D0 | D1 | D2 | Setting | Setting                           |
|----|----|----|---------|-----------------------------------|
| 0  | 0  | 0  | L1 (R1) |                                   |
| 1  | 0  | 0  | L2 (R2) |                                   |
| 0  | 1  | 0  | L3 (R3) |                                   |
| 1  | 1  | 0  | L4 (R4) |                                   |
| 0  | 0  | 1  | L5 (R5) |                                   |
| 0  | 1  | 1  |         | For IC testing: Normally not used |
| 1  | 1  | 1  |         |                                   |

|    |                                       |
|----|---------------------------------------|
| D3 | Bit for IC testing: Normally set to 0 |
|----|---------------------------------------|

#### Input Gain Control

| D4 | D5 | D6 | D7 | Operation |
|----|----|----|----|-----------|
| 0  | 0  | 0  | 0  | 0dB       |
| 1  | 0  | 0  | 0  | +1.25dB   |
| 0  | 1  | 0  | 0  | +2.50dB   |
| 1  | 1  | 0  | 0  | +3.75dB   |
| 0  | 0  | 1  | 0  | +5.00dB   |
| 1  | 0  | 1  | 0  | +6.25dB   |
| 0  | 1  | 1  | 0  | +7.50dB   |
| 1  | 1  | 1  | 0  | +8.75dB   |
| 0  | 0  | 0  | 1  | +10.0dB   |
| 1  | 0  | 0  | 1  | +11.25dB  |
| 0  | 1  | 0  | 1  | +12.5dB   |
| 1  | 1  | 0  | 1  | +13.75dB  |
| 0  | 0  | 1  | 1  | +15.0dB   |
| 1  | 0  | 1  | 1  | +16.25dB  |
| 0  | 1  | 1  | 1  | +17.5dB   |
| 1  | 1  | 1  | 1  | +18.75dB  |

## LC75410E, 75410W

### Volume Control (0 to -20.5dB)

| D8 | D9 | D10 | D11 | D12 | D13 | D14 | D15 | Operation |
|----|----|-----|-----|-----|-----|-----|-----|-----------|
| 0  | 0  | 0   | 0   | 0   | 0   | 0   | 0   | 0dB       |
| 0  | 0  | 0   | 0   | 0   | 0   | 0   | 1   | -0.5dB    |
| 1  | 0  | 0   | 0   | 0   | 0   | 0   | 0   | -1dB      |
| 1  | 0  | 0   | 0   | 0   | 0   | 0   | 1   | -1.5dB    |
| 0  | 1  | 0   | 0   | 0   | 0   | 0   | 0   | -2dB      |
| 0  | 1  | 0   | 0   | 0   | 0   | 0   | 1   | -2.5dB    |
| 1  | 1  | 0   | 0   | 0   | 0   | 0   | 0   | -3dB      |
| 1  | 1  | 0   | 0   | 0   | 0   | 0   | 1   | -3.5dB    |
| 0  | 0  | 1   | 0   | 0   | 0   | 0   | 0   | -4dB      |
| 0  | 0  | 1   | 0   | 0   | 0   | 0   | 1   | -4.5dB    |
| 1  | 0  | 1   | 0   | 0   | 0   | 0   | 0   | -5dB      |
| 1  | 0  | 1   | 0   | 0   | 0   | 0   | 1   | -5.5dB    |
| 0  | 1  | 1   | 0   | 0   | 0   | 0   | 0   | -6dB      |
| 0  | 1  | 1   | 0   | 0   | 0   | 0   | 1   | -6.5dB    |
| 1  | 1  | 1   | 0   | 0   | 0   | 0   | 0   | -7dB      |
| 1  | 1  | 1   | 0   | 0   | 0   | 0   | 1   | -7.5dB    |
| 0  | 0  | 0   | 1   | 0   | 0   | 0   | 0   | -8dB      |
| 0  | 0  | 0   | 1   | 0   | 0   | 0   | 1   | -8.5dB    |
| 1  | 0  | 0   | 1   | 0   | 0   | 0   | 0   | -9dB      |
| 1  | 0  | 0   | 1   | 0   | 0   | 0   | 1   | -9.5dB    |
| 0  | 1  | 0   | 1   | 0   | 0   | 0   | 0   | -10dB     |
| 0  | 1  | 0   | 1   | 0   | 0   | 0   | 1   | -10.5dB   |
| 1  | 1  | 0   | 1   | 0   | 0   | 0   | 0   | -11dB     |
| 1  | 1  | 0   | 1   | 0   | 0   | 0   | 1   | -11.5dB   |
| 0  | 0  | 1   | 1   | 0   | 0   | 0   | 0   | -12dB     |
| 0  | 0  | 1   | 1   | 0   | 0   | 0   | 1   | -12.5dB   |
| 1  | 0  | 1   | 1   | 0   | 0   | 0   | 0   | -13dB     |
| 1  | 0  | 1   | 1   | 0   | 0   | 0   | 1   | -13.5dB   |
| 0  | 1  | 1   | 1   | 0   | 0   | 0   | 0   | -14dB     |
| 0  | 1  | 1   | 1   | 0   | 0   | 0   | 1   | -14.5dB   |
| 1  | 1  | 1   | 1   | 0   | 0   | 0   | 0   | -15dB     |
| 1  | 1  | 1   | 1   | 0   | 0   | 0   | 1   | -15.5dB   |
| 0  | 0  | 0   | 0   | 1   | 0   | 0   | 0   | -16dB     |
| 0  | 0  | 0   | 0   | 1   | 0   | 0   | 1   | -16.5dB   |
| 1  | 0  | 0   | 0   | 1   | 0   | 0   | 0   | -17dB     |
| 1  | 0  | 0   | 0   | 1   | 0   | 0   | 1   | -17.5dB   |
| 0  | 1  | 0   | 0   | 1   | 0   | 0   | 0   | -18dB     |
| 0  | 1  | 0   | 0   | 1   | 0   | 0   | 1   | -18.5dB   |
| 1  | 1  | 0   | 0   | 1   | 0   | 0   | 0   | -19dB     |
| 1  | 1  | 0   | 0   | 1   | 0   | 0   | 1   | -19.5dB   |
| 0  | 0  | 1   | 0   | 1   | 0   | 0   | 0   | -20dB     |
| 0  | 0  | 1   | 0   | 1   | 0   | 0   | 1   | -20.5dB   |

## LC75410E, 75410W

### Volume Control (-21 to -40.5dB)

| D8 | D9 | D10 | D11 | D12 | D13 | D14 | D15 | Operation |
|----|----|-----|-----|-----|-----|-----|-----|-----------|
| 1  | 0  | 1   | 0   | 1   | 0   | 0   | 0   | -21dB     |
| 1  | 0  | 1   | 0   | 1   | 0   | 0   | 1   | -21.5dB   |
| 0  | 1  | 1   | 0   | 1   | 0   | 0   | 0   | -22dB     |
| 0  | 1  | 1   | 0   | 1   | 0   | 0   | 1   | -22.5dB   |
| 1  | 1  | 1   | 0   | 1   | 0   | 0   | 0   | -23dB     |
| 1  | 1  | 1   | 0   | 1   | 0   | 0   | 1   | -23.5dB   |
| 0  | 0  | 0   | 1   | 1   | 0   | 0   | 0   | -24dB     |
| 0  | 0  | 0   | 1   | 1   | 0   | 0   | 1   | -24.5dB   |
| 1  | 0  | 0   | 1   | 1   | 0   | 0   | 0   | -25dB     |
| 1  | 0  | 0   | 1   | 1   | 0   | 0   | 1   | -25.5dB   |
| 0  | 1  | 0   | 1   | 1   | 0   | 0   | 0   | -26dB     |
| 0  | 1  | 0   | 1   | 1   | 0   | 0   | 1   | -26.5dB   |
| 1  | 1  | 0   | 1   | 1   | 0   | 0   | 0   | -27dB     |
| 1  | 1  | 0   | 1   | 1   | 0   | 0   | 1   | -27.5dB   |
| 0  | 0  | 1   | 1   | 1   | 0   | 0   | 0   | -28dB     |
| 0  | 0  | 1   | 1   | 1   | 0   | 0   | 1   | -28.5dB   |
| 1  | 0  | 1   | 1   | 1   | 0   | 0   | 0   | -29dB     |
| 1  | 0  | 1   | 1   | 1   | 0   | 0   | 1   | -29.5dB   |
| 0  | 1  | 1   | 1   | 1   | 0   | 0   | 0   | -30dB     |
| 0  | 1  | 1   | 1   | 1   | 0   | 0   | 1   | -30.5dB   |
| 1  | 1  | 1   | 1   | 1   | 0   | 0   | 0   | -31dB     |
| 1  | 1  | 1   | 1   | 1   | 0   | 0   | 1   | -31.5dB   |
| 0  | 0  | 0   | 0   | 0   | 1   | 0   | 0   | -32dB     |
| 0  | 0  | 0   | 0   | 0   | 1   | 0   | 1   | -32.5dB   |
| 1  | 0  | 0   | 0   | 0   | 1   | 0   | 0   | -33dB     |
| 1  | 0  | 0   | 0   | 0   | 1   | 0   | 1   | -33.5dB   |
| 0  | 1  | 0   | 0   | 0   | 1   | 0   | 0   | -34dB     |
| 0  | 1  | 0   | 0   | 0   | 1   | 0   | 1   | -34.5dB   |
| 1  | 1  | 0   | 0   | 0   | 1   | 0   | 0   | -35dB     |
| 1  | 1  | 0   | 0   | 0   | 1   | 0   | 1   | -35.5dB   |
| 0  | 0  | 1   | 0   | 0   | 1   | 0   | 0   | -36dB     |
| 0  | 0  | 1   | 0   | 0   | 1   | 0   | 1   | -36.5dB   |
| 1  | 0  | 1   | 0   | 0   | 1   | 0   | 0   | -37dB     |
| 1  | 0  | 1   | 0   | 0   | 1   | 0   | 1   | -37.5dB   |
| 0  | 1  | 1   | 0   | 0   | 1   | 0   | 0   | -38dB     |
| 0  | 1  | 1   | 0   | 0   | 1   | 0   | 1   | -38.5dB   |
| 1  | 1  | 1   | 0   | 0   | 1   | 0   | 0   | -39dB     |
| 1  | 1  | 1   | 0   | 0   | 1   | 0   | 1   | -39.5dB   |
| 0  | 0  | 0   | 1   | 0   | 1   | 0   | 0   | -40dB     |
| 0  | 0  | 0   | 1   | 0   | 1   | 0   | 1   | -40.5dB   |



## LC75410E, 75410W

### Volume Control (-41 to -59.5dB)

| D8 | D9 | D10 | D11 | D12 | D13 | D14 | D15 | Operation |
|----|----|-----|-----|-----|-----|-----|-----|-----------|
| 1  | 0  | 0   | 1   | 0   | 1   | 0   | 0   | -41dB     |
| 1  | 0  | 0   | 1   | 0   | 1   | 0   | 1   | -41.5dB   |
| 0  | 1  | 0   | 1   | 0   | 1   | 0   | 0   | -42dB     |
| 0  | 1  | 0   | 1   | 0   | 1   | 0   | 1   | -42.5dB   |
| 1  | 1  | 0   | 1   | 0   | 1   | 0   | 0   | -43dB     |
| 1  | 1  | 0   | 1   | 0   | 1   | 0   | 1   | -43.5dB   |
| 0  | 0  | 1   | 1   | 0   | 1   | 0   | 0   | -44dB     |
| 0  | 0  | 1   | 1   | 0   | 1   | 0   | 1   | -44.5dB   |
| 1  | 0  | 1   | 1   | 0   | 1   | 0   | 0   | -45dB     |
| 1  | 0  | 1   | 1   | 0   | 1   | 0   | 1   | -45.5dB   |
| 0  | 1  | 1   | 1   | 0   | 1   | 0   | 0   | -46dB     |
| 0  | 1  | 1   | 1   | 0   | 1   | 0   | 1   | -46.5dB   |
| 1  | 1  | 1   | 1   | 0   | 1   | 0   | 0   | -47dB     |
| 1  | 1  | 1   | 1   | 0   | 1   | 0   | 1   | -47.5dB   |
| 0  | 0  | 0   | 0   | 1   | 1   | 0   | 0   | -48dB     |
| 0  | 0  | 0   | 0   | 1   | 1   | 0   | 1   | -48.5dB   |
| 1  | 0  | 0   | 0   | 1   | 1   | 0   | 0   | -49dB     |
| 1  | 0  | 0   | 0   | 1   | 1   | 0   | 1   | -49.5dB   |
| 0  | 1  | 0   | 0   | 1   | 1   | 0   | 0   | -50dB     |
| 0  | 1  | 0   | 0   | 1   | 1   | 0   | 1   | -50.5dB   |
| 1  | 1  | 0   | 0   | 1   | 1   | 0   | 0   | -51dB     |
| 1  | 1  | 0   | 0   | 1   | 1   | 0   | 1   | -51.5dB   |
| 0  | 0  | 1   | 0   | 1   | 1   | 0   | 0   | -52dB     |
| 0  | 0  | 1   | 0   | 1   | 1   | 0   | 1   | -52.5dB   |
| 1  | 0  | 1   | 0   | 1   | 1   | 0   | 0   | -53dB     |
| 1  | 0  | 1   | 0   | 1   | 1   | 0   | 1   | -53.5dB   |
| 0  | 1  | 1   | 0   | 1   | 1   | 0   | 0   | -54dB     |
| 0  | 1  | 1   | 0   | 1   | 1   | 0   | 1   | -54.5dB   |
| 1  | 1  | 1   | 0   | 1   | 1   | 0   | 0   | -55dB     |
| 1  | 1  | 1   | 0   | 1   | 1   | 0   | 1   | -55.5dB   |
| 0  | 0  | 0   | 1   | 1   | 1   | 0   | 0   | -56dB     |
| 0  | 0  | 0   | 1   | 1   | 1   | 0   | 1   | -56.5dB   |
| 1  | 0  | 0   | 1   | 1   | 1   | 0   | 0   | -57dB     |
| 1  | 0  | 0   | 1   | 1   | 1   | 0   | 1   | -57.5dB   |
| 0  | 1  | 0   | 1   | 1   | 1   | 0   | 0   | -58dB     |
| 0  | 1  | 0   | 1   | 1   | 1   | 0   | 1   | -58.5dB   |
| 1  | 1  | 0   | 1   | 1   | 1   | 0   | 0   | -59dB     |
| 1  | 1  | 0   | 1   | 1   | 1   | 0   | 1   | -59.5dB   |

## LC75410E, 75410W

Volume Control (-60 to  $-\infty$ )

| D8 | D9 | D10 | D11 | D12 | D13 | D14 | D15 | Operation |
|----|----|-----|-----|-----|-----|-----|-----|-----------|
| 0  | 0  | 1   | 1   | 1   | 1   | 0   | 0   | -60dB     |
| 0  | 0  | 1   | 1   | 1   | 1   | 0   | 1   | -60.5dB   |
| 1  | 0  | 1   | 1   | 1   | 1   | 0   | 0   | -61dB     |
| 1  | 0  | 1   | 1   | 1   | 1   | 0   | 1   | -61.5dB   |
| 0  | 1  | 1   | 1   | 1   | 1   | 0   | 0   | -62dB     |
| 0  | 1  | 1   | 1   | 1   | 1   | 0   | 1   | -62.5dB   |
| 1  | 1  | 1   | 1   | 1   | 1   | 0   | 0   | -63dB     |
| 1  | 1  | 1   | 1   | 1   | 1   | 0   | 1   | -63.5dB   |
| 0  | 0  | 0   | 0   | 0   | 0   | 1   | 0   | -64dB     |
| 0  | 0  | 0   | 0   | 0   | 0   | 1   | 1   | -64.5dB   |
| 1  | 0  | 0   | 0   | 0   | 0   | 1   | 0   | -65dB     |
| 1  | 0  | 0   | 0   | 0   | 0   | 1   | 1   | -65.5dB   |
| 0  | 1  | 0   | 0   | 0   | 0   | 1   | 0   | -66dB     |
| 0  | 1  | 0   | 0   | 0   | 0   | 1   | 1   | -66.5dB   |
| 1  | 1  | 0   | 0   | 0   | 0   | 1   | 0   | -67dB     |
| 1  | 1  | 0   | 0   | 0   | 0   | 1   | 1   | -67.5dB   |
| 0  | 0  | 1   | 0   | 0   | 0   | 1   | 0   | -68dB     |
| 0  | 0  | 1   | 0   | 0   | 0   | 1   | 1   | -68.5dB   |
| 1  | 0  | 1   | 0   | 0   | 0   | 1   | 0   | -69dB     |
| 1  | 0  | 1   | 0   | 0   | 0   | 1   | 1   | -69.5dB   |
| 0  | 1  | 1   | 0   | 0   | 0   | 1   | 0   | -70dB     |
| 0  | 1  | 1   | 0   | 0   | 0   | 1   | 1   | -70.5dB   |
| 1  | 1  | 1   | 0   | 0   | 0   | 1   | 0   | -71dB     |
| 1  | 1  | 1   | 0   | 0   | 0   | 1   | 1   | -71.5dB   |
| 0  | 0  | 0   | 1   | 0   | 0   | 1   | 0   | -72dB     |
| 0  | 0  | 0   | 1   | 0   | 0   | 1   | 1   | -72.5dB   |
| 1  | 0  | 0   | 1   | 0   | 0   | 1   | 0   | -73dB     |
| 1  | 0  | 0   | 1   | 0   | 0   | 1   | 1   | -73.5dB   |
| 0  | 1  | 0   | 1   | 0   | 0   | 1   | 0   | -74dB     |
| 0  | 1  | 0   | 1   | 0   | 0   | 1   | 1   | -74.5dB   |
| 1  | 1  | 0   | 1   | 0   | 0   | 1   | 0   | -75dB     |
| 1  | 1  | 0   | 1   | 0   | 0   | 1   | 1   | -75.5dB   |
| 0  | 0  | 1   | 1   | 0   | 0   | 1   | 0   | -76dB     |
| 0  | 0  | 1   | 1   | 0   | 0   | 1   | 1   | -76.5dB   |
| 1  | 0  | 1   | 1   | 0   | 0   | 1   | 0   | -77dB     |
| 1  | 0  | 1   | 1   | 0   | 0   | 1   | 1   | -77.5dB   |
| 0  | 1  | 1   | 1   | 0   | 0   | 1   | 0   | -78dB     |
| 0  | 1  | 1   | 1   | 0   | 0   | 1   | 1   | -78.5dB   |
| 1  | 1  | 1   | 1   | 0   | 0   | 1   | 0   | -79dB     |
| 1  | 1  | 1   | 1   | 0   | 0   | 1   | 1   | -79.5dB   |
| 0  | 1  | 1   | 1   | 1   | 1   | 1   | 0   | $-\infty$ |

## LC75410E, 75410W

### Three-Band Equalizer Control

| D16 | D17 | D18 | D19 | D40 | f1 band |
|-----|-----|-----|-----|-----|---------|
| D20 | D21 | D22 | D23 | D41 | f2 band |
| D24 | D25 | D26 | D27 | D42 | f3 band |
| 0   | 1   | 1   | 0   | 0   | +12dB   |
| 1   | 0   | 1   | 0   | 0   | +10dB   |
| 0   | 0   | 1   | 0   | 0   | +8dB    |
| 1   | 1   | 0   | 0   | 0   | +6dB    |
| 1   | 1   | 0   | 0   | 1   | +5dB    |
| 0   | 1   | 0   | 0   | 0   | +4dB    |
| 0   | 1   | 0   | 0   | 1   | +3dB    |
| 1   | 0   | 0   | 0   | 0   | +2dB    |
| 1   | 0   | 0   | 0   | 1   | +1dB    |
| 0   | 0   | 0   | 0   | 0   | 0dB     |
| 1   | 0   | 0   | 1   | 1   | -1dB    |
| 1   | 0   | 0   | 1   | 0   | -2dB    |
| 0   | 1   | 0   | 1   | 1   | -3dB    |
| 0   | 1   | 0   | 1   | 0   | -4dB    |
| 1   | 1   | 0   | 1   | 1   | -5dB    |
| 1   | 1   | 0   | 1   | 0   | -6dB    |
| 0   | 0   | 1   | 1   | 0   | -8dB    |
| 1   | 0   | 1   | 1   | 0   | -10dB   |
| 0   | 1   | 1   | 1   | 0   | -12dB   |

### Fader Volume Control

| D28 | D29 | D30 | D31 | Operation |
|-----|-----|-----|-----|-----------|
| 0   | 0   | 0   | 0   | 0dB       |
| 1   | 0   | 0   | 0   | -1dB      |
| 0   | 1   | 0   | 0   | -2dB      |
| 1   | 1   | 0   | 0   | -4dB      |
| 0   | 0   | 1   | 0   | -6dB      |
| 1   | 0   | 1   | 0   | -8dB      |
| 0   | 1   | 1   | 0   | -10dB     |
| 1   | 1   | 1   | 0   | -12dB     |
| 0   | 0   | 0   | 1   | -14dB     |
| 1   | 0   | 0   | 1   | -16dB     |
| 0   | 1   | 0   | 1   | -18dB     |
| 1   | 1   | 0   | 1   | -20dB     |
| 0   | 0   | 1   | 1   | -30dB     |
| 1   | 0   | 1   | 1   | -45dB     |
| 0   | 1   | 1   | 1   | -60dB     |
| 1   | 1   | 1   | 1   | -∞        |

### Channel Selection Control

| D32 | D33 | Operation                                |
|-----|-----|--|
| 0   | 0   | L/R simultaneously, Initial setting mode |
| 1   | 0   | RCH                                      |
| 0   | 1   | LCH                                      |
| 1   | 1   | L/R simultaneously                       |

Fader Rear/Front Control

| D34 | Setting |
|-----|---------|
| 0   | Rear    |
| 1   | Front   |

Loudness Control

| D35 | Setting |
|-----|---------|
| 0   | OFF     |
| 1   | ON      |

Zero-Cross Control

| D36 | D37 | Setting   |
|-----|-----|---|
| 0   | 0   | Data write through zero-cross detection                         |
| 1   | 1   | Zero-cross detection stopped (data write at falling edge of CE) |

Zero-Cross Signal Detection Block Control

| D38 | D39 | Setting  |
|-----|-----|----------|
| 0   | 0   | Selector |
| 1   | 0   | Volume   |
| 0   | 1   | Tone     |
| 1   | 1   | Fader    |

Test Mode Control

| D43 | Setting                          |
|-----|----------------------------------|
| 0   | For IC testing. Always set to 0. |

Pin Functions

| Pin Name                                     | Pin No.                                      | Function  | Equivalent circuit |
|--|--|---|--------------------|
| L1<br>L2<br>L3<br>L4<br>R1<br>R2<br>R3<br>R4 | 54<br>53<br>52<br>51<br>59<br>60<br>61<br>62 | • Single-end input pins   |                    |
| L5M<br>L5P<br>R5M<br>R5P                     | 50<br>49<br>63<br>64                         | • Differential input pins   |                    |
| LSEL0<br>RSEL0                               | 48<br>1                                      | • Input selector output pins  |                    |
| LVRIN<br>RVRIN                               | 47<br>2                                      | • 2-dB step volume input pins<br>• Perform input at low-impedance.  |                    |
| LCT<br>RCT                                   | 46<br>3                                      | • Loudness pins. Connect high-pass compensation RC between LCT (RCT) and LVRIN (RVRIN), and connect low-pass compensation RC between LCT (RCT) and GND. |                    |
| LCOM<br>RCOM                                 | 45<br>4                                      | • 2-dB stop volume output pins.<br>• To reduce switching noise, each of these pins should be connected to Vref through a capacitor.                     |                    |
| LVROUT<br>RVROUT                             | 44<br>5                                      | • 0.5-dB step volume output pin   |                    |

Continued on next page.

## LC75410E, 75410W

Continued from preceding page.

| Pin Name   | Pin No.                          | Function  | Equivalent circuit |
|--|----------------------------------|---|--------------------|
| LTIN<br>RTIN                                       | 43<br>6                          | <ul style="list-style-type: none"> <li>Equalizer input pin</li> </ul>   |                    |
| LF1C1<br>LF1C2<br>LF1C3<br>RF1C1<br>RF1C2<br>RF1C3 | 42<br>41<br>40<br>7<br>8<br>9    | <ul style="list-style-type: none"> <li>Equalizer F1 band circuit filter configuration capacitor connection pins.</li> <li>Connect capacitor between LF1C1 (RF1C1) and LF1C2 (RF1C2)</li> <li>LF1C2 (RF1C2) and LF1C3 (RF1C3)</li> </ul> |                    |
| LF2C1<br>LF2C2<br>LF2C3<br>RF2C1<br>RF2C2<br>RF2C3 | 39<br>38<br>37<br>10<br>11<br>12 | <ul style="list-style-type: none"> <li>Equalizer F2 band circuit filter configuration capacitor connection pins.</li> <li>Connect capacitor between LF2C1 (RF2C1) and LF2C2 (RF2C2)</li> <li>LF2C2 (RF2C2) and LF2C3 (RF2C3)</li> </ul> |                    |
| LF3C1<br>LF3C2<br>LF3C3<br>RF3C1<br>RF3C2<br>RF3C3 | 36<br>35<br>34<br>13<br>14<br>15 | <ul style="list-style-type: none"> <li>Equalizer F3 band circuit filter configuration capacitor connection pins.</li> <li>Connect capacitor between LF3C1 (RF3C1) and LF3C2 (RF3C2)</li> <li>LF3C2 (RF3C2) and LF3C3 (RF3C3)</li> </ul> |                    |
| LTOUT<br>RTOUT                                     | 33<br>16                         | <ul style="list-style-type: none"> <li>Equalizer output pins</li> </ul>   |                    |
| LFIN<br>RFIN                                       | 32<br>17                         | <ul style="list-style-type: none"> <li>Fader block input pins</li> <li>Drive at low impedance.</li> </ul>   |                    |
| LFOUT<br>LROUT<br>RFOUT<br>RROUT                   | 31<br>30<br>18<br>19             | <ul style="list-style-type: none"> <li>Fader output pins. Attenuation is possible separately for the front end and rear end. The attenuation amount is the same for L and R.</li> </ul>   |                    |
| Vref   | 57                               | <ul style="list-style-type: none"> <li>Connect a capacitor of a few tens of <math>\mu\text{F}</math> between Vref and AVSS (VSS) as a 0.55 VDD voltage generator, current ripple countermeasure.</li> </ul>                             |                    |
| LVref<br>RVref                                     | 55<br>58                         | <ul style="list-style-type: none"> <li>Internal analog system ground pins.</li> </ul>   |                    |

Continued on next page.

## LC75410E, 75410W

Continued from preceding page.

| Pin Name                 | Pin No.  | Function   | Equivalent circuit |
|--------------------------|----------|--|--------------------|
| VDD                      | 56       | <ul style="list-style-type: none"> <li>Power supply pin</li> </ul>   |                    |
| DVSS                     | 27       | <ul style="list-style-type: none"> <li>Logic system ground pin</li> </ul>  |                    |
| LAVSS<br>RAVSS           | 29<br>22 | <ul style="list-style-type: none"> <li>Analog system ground pins</li> </ul>  |                    |
| $\overline{\text{MUTE}}$ | 23       | <ul style="list-style-type: none"> <li>External muting control pin</li> <li>Setting this pin to <math>V_{SS}</math> level sets forcibly fader volume block to <math>-\infty</math> level.</li> </ul>   |                    |
| TIM                      | 20       | <ul style="list-style-type: none"> <li>Timer pin when there is no signal in the zero-cross circuit.</li> <li>Forcibly set data when there is no zero-cross signal, from the time the data is set until the timer ends.</li> </ul>                |                    |
| CL<br>DI                 | 26<br>25 | <ul style="list-style-type: none"> <li>Input pin for serial data and clock used for control</li> </ul>   |                    |
| CE                       | 24       | <ul style="list-style-type: none"> <li>Chip enable pin. Data is written to the internal latch and the analog switches are operated when the level changes from High to Low.</li> <li>Data transfer is enabled when the level is High.</li> </ul> |                    |
| TEST                     | 28       | <ul style="list-style-type: none"> <li>Dedicated IC test pin.</li> <li>Normally this pin is used connected to GND.</li> </ul>  |                    |
| NC                       | 21       | <ul style="list-style-type: none"> <li>No Connect pin.</li> </ul>  |                    |

Internal Equivalent Circuit Block Diagram

Selector Block Equivalent Circuit Block Diagram

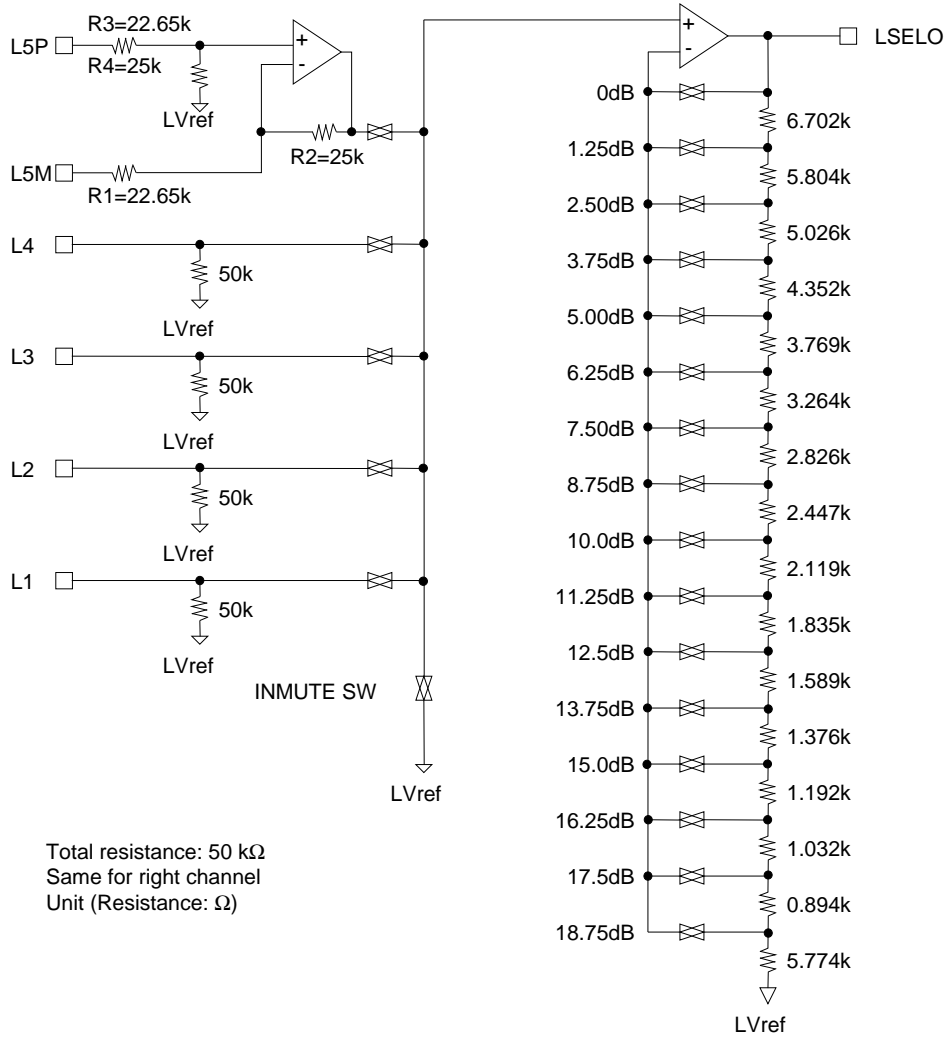



LC75410E, 75410W

2-dB Volume Block Equivalent Circuit Block Diagram

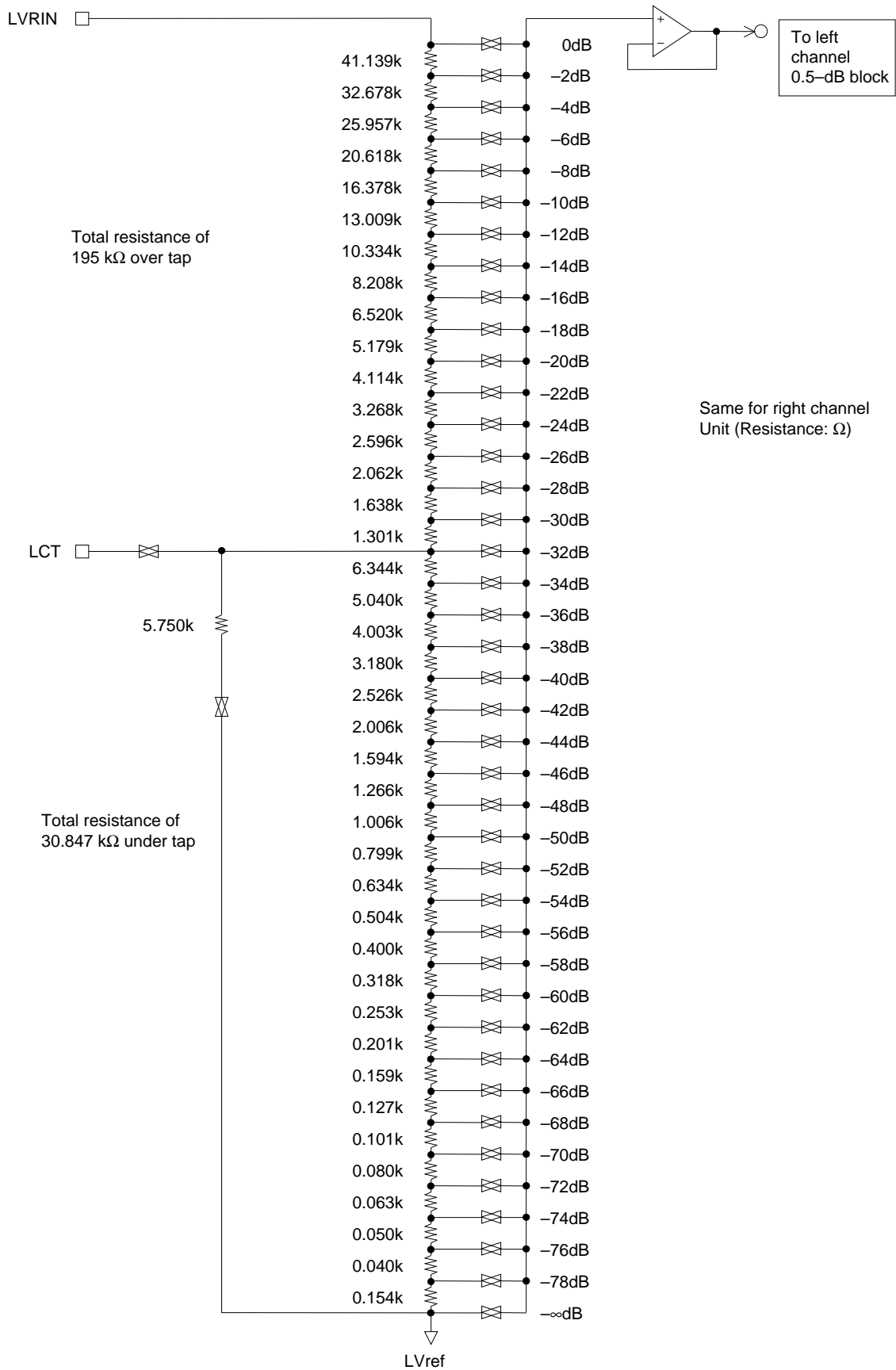

0.5-dB Volume Block Equivalent Circuit Block Diagram

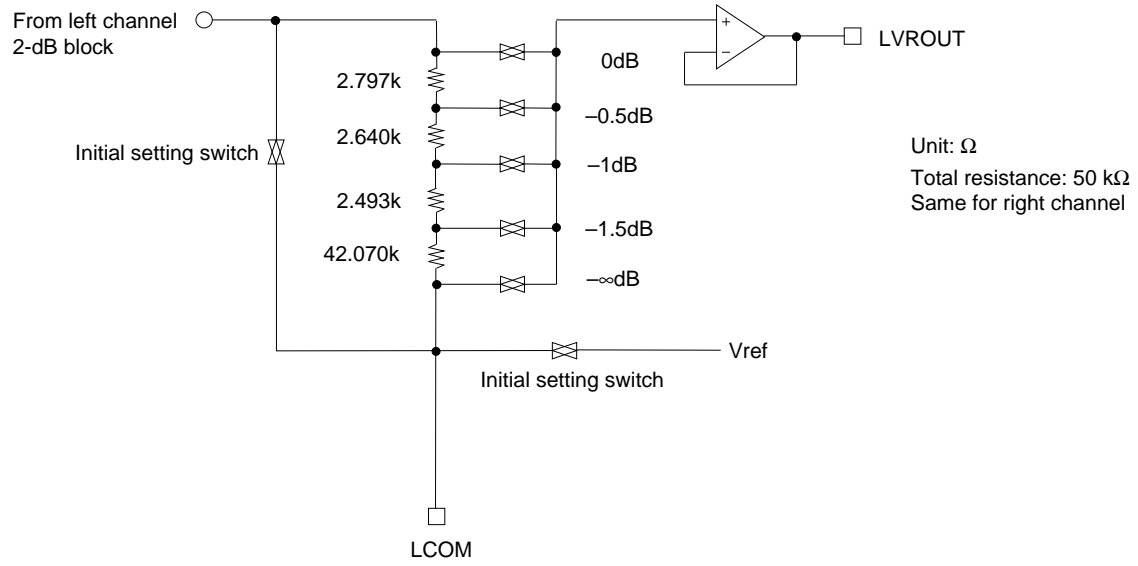

## LC75410E, 75410W

### 3-Band Graphic Equalizer Block Equivalent Circuit Diagram

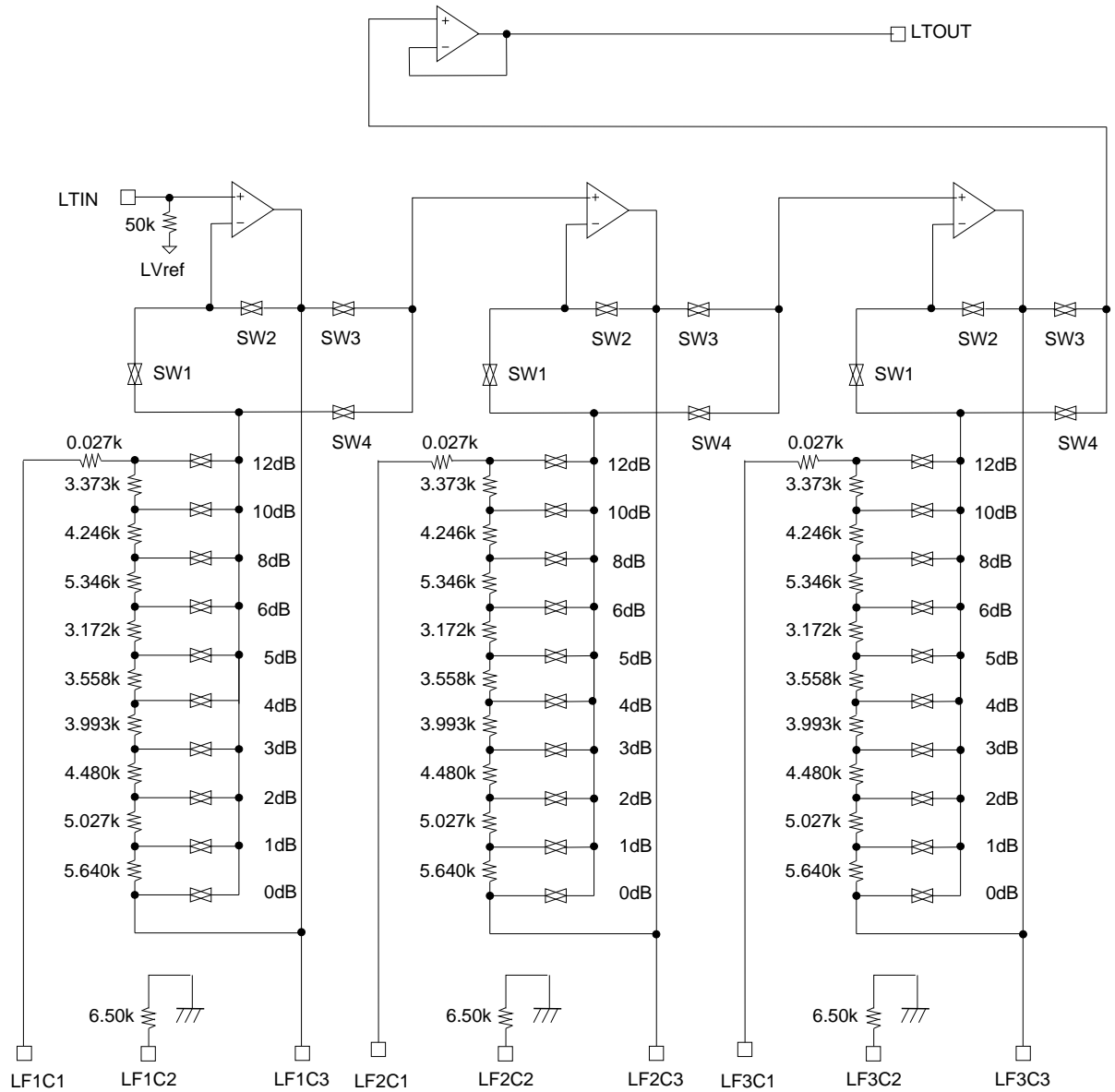

Unit:  $\Omega$   
 Total resistance: 38.861 k $\Omega$   
 Same for right channel

During boost, SW 1 and SW 3 are ON, during cut SW 2 and SW 4 are ON,  
 and when 0 dB, 0 dB SW and SW 2 and SW 3 are ON.

F1/F2/F3 Band Circuit

The equivalent circuit and the formula for calculating the external RC with a mean frequency of 1 kHz are shown below.

- F1/F2/F3 band equivalent circuit block diagram

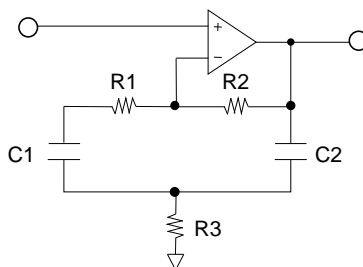

- Calculation example

Specification Mean frequency:  $f_0 = 1 \text{ kHz}$

Gain during maximum boost:  $G_{+12 \text{ dB}} = 12 \text{ dB}$

Let us use  $R_1 = 0.027 \text{ k}\Omega$ ,  $R_2 = 38.861 \text{ k}\Omega$  and  $C_1 = C_2 = C$ .

1. Calculate  $R_2$  with  $G_{+12 \text{ dB}} = 12 \text{ dB}$ :

$$G_{+12 \text{ dB}} = 20 \times \text{LOG}_{10} \left( 1 + \frac{R_2}{2R_3 + R_1} \right)$$

$$R_3 = \left( \frac{R_2}{10^{G/20} - 1} - R_1 \right) \div 2 \cong 6.5 \text{ k}\Omega$$

2. Calculate  $C$  with the center frequency  $f_0 = 1 \text{ kHz}$

$$f_0 = \frac{1}{2\pi \sqrt{(R_1 + R_2)R_3 C_1 C_2}}$$

$$C = \frac{1}{2\pi f_0 \sqrt{(R_1 + R_2)R_3}} = \frac{1}{2\pi \times 1000 \sqrt{38888 \times 6500}} = 0.010 \times 10^{-6} \cong 0.01 \text{ }\mu\text{F}$$

3. Calculate  $Q$ :

$$Q = \frac{1}{\sqrt{(R_1 + R_2)R_3}} \times \frac{R_3(R_1 + R_2)}{(2R_3 + R_1)} \cong 1.22$$

LC75410E, 75410W

Fader Volume Block Equivalent Circuit Block Diagram

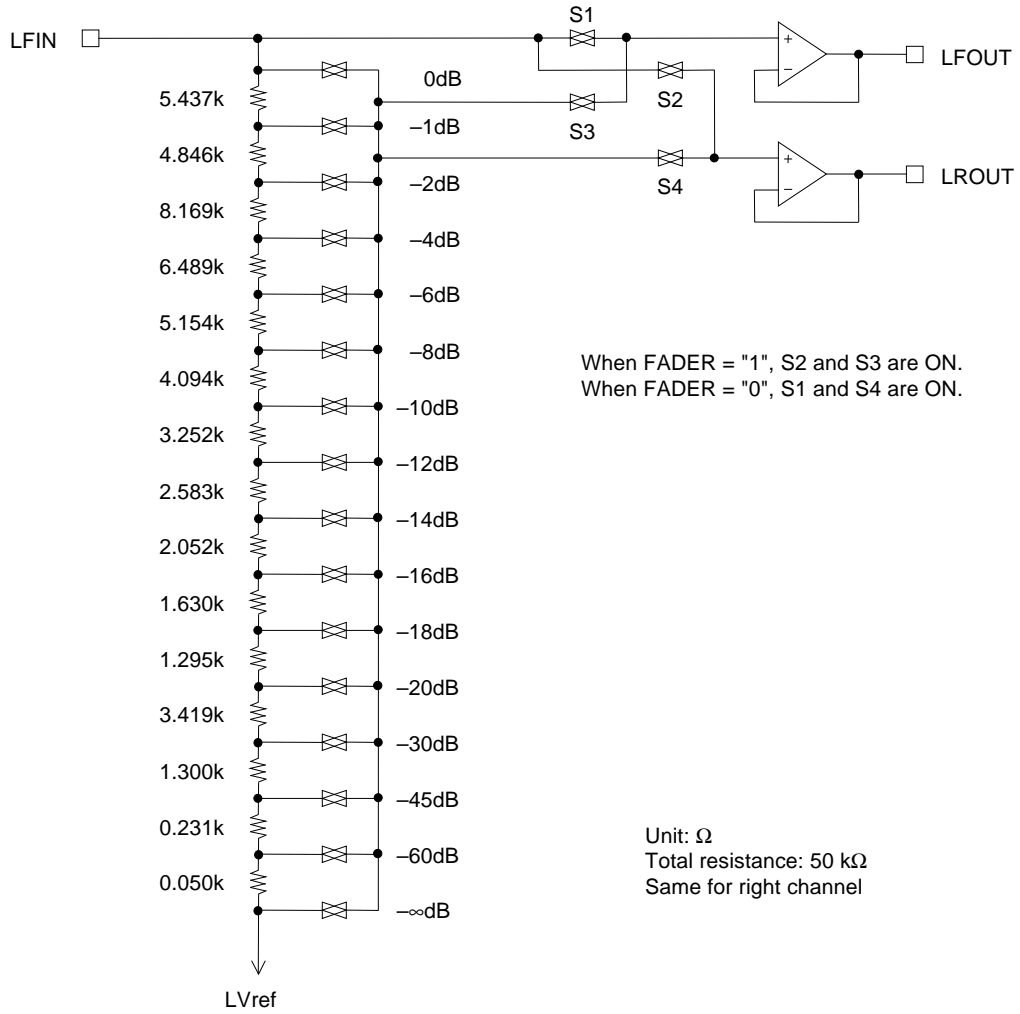

When  $-\infty$  data is sent to the main volume, S1 and S2 become open, and S3 and S4 simultaneously become ON.

**Usage Cautions**

(1) Data transmission at power ON

- The status of internal analog switches is unstable at power ON. Therefore, perform muting or some other countermeasure until the data has been set.
- At power ON, initial setting data must be sent once in order to stabilize the bias of each block in a short time.

(2) Description of zero-cross switching circuit operation

The LC75410E and 75410W have a function to switch zero-cross comparator signal detection locations, enabling the selection of the optimum detection location for blocks whose data is to be updated. Basically, the switching noise can be minimized by inputting the signal immediately following the block whose data is to be updated to the zero-cross comparator, so it is necessary to switch the detection location every time.

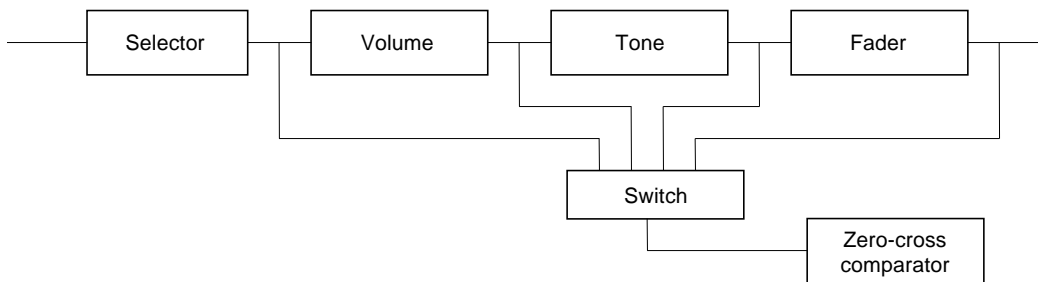

**LC75410E, 75410W Zero-Cross Detection Circuit**

(3) Zero-cross switching control method

The zero-cross switching control method consists of setting the zero-cross control bits to the zero-cross detection mode (D36, D37 = 0), and specifying the detection blocks (D38, D39) before transmitting the data. These control bits are latched immediately following data transfer, that is to say beforehand in sync with the falling edge of CE, so when updating data of volumes, etc., it is possible to perform mode setting and zero-cross switching with one data transfer. An example of control when updating the data of the volume block is shown below.

| D36 | D37 | D38 | D39 |
|-----|-----|-----|-----|
| 0   | 0   | 1   | 0   |

Zero-cross detection mode setting
Volume block setting

(4) Zero-cross timer setting

If the input signal becomes lower than the zero-cross comparator detection sensitivity, or if only low-frequency signals are input, zero-cross detection continues to be impossible, and data is not latched during this time. The zero-cross timer can set a time for forcible latch during such a status when zero-cross detection is not possible.

For example, to set 25 ms,  
 using  $T = 0.69CR$  and  $C = 0.033 \mu\text{F}$ ,  
 we obtain

$$R = \frac{25 \times 10^{-3}}{0.69 \times 0.033 \times 10^{-6}} \approx 1.1 \text{ M}\Omega$$

Normally, a value between 10 ms and 50 ms is set.

(5) Cautions related to serial data transfer

1. To ensure that the high-frequency digital signals transferred to the CL, DI, and CE pins do not spill over to the analog signal block, either guard these signal lines with a ground pattern, or perform transmission using shielded wires.
2. The data format of the LC75410E and 75410W uses 8-bit addresses and 44-bit data. When sending data using multiples of 8 (when sending 48 bits), use the method described in Figure 1.

Method for Receiving Data Using Multiple of 8 of LC75410E and 75410W

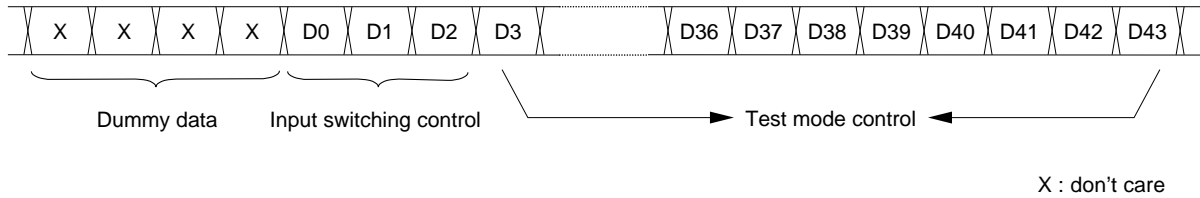
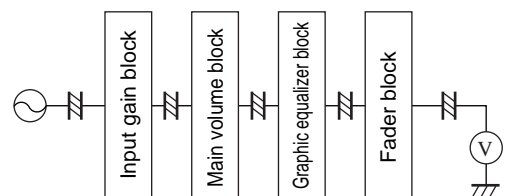
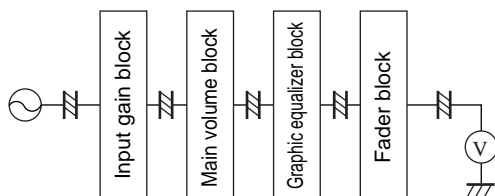
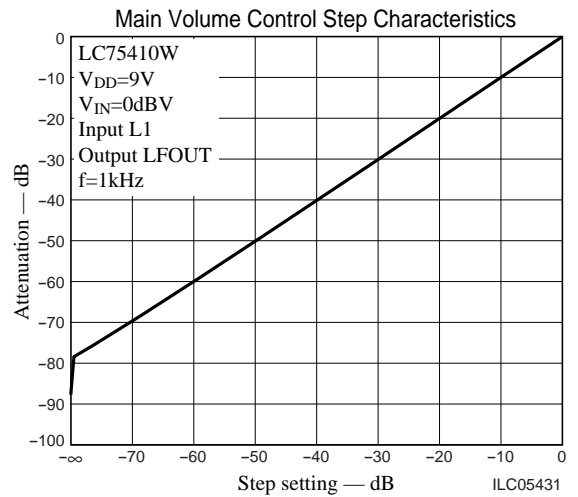
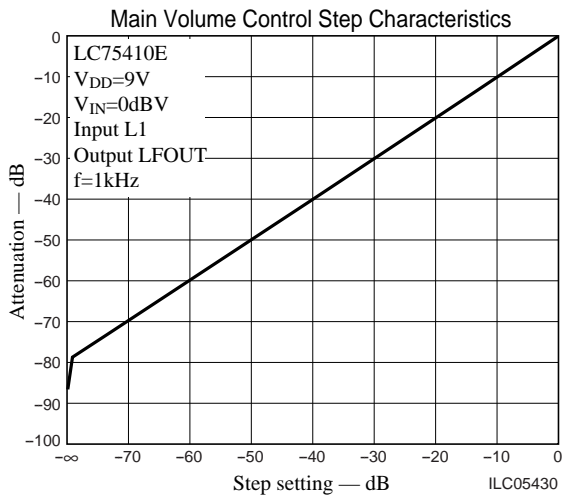
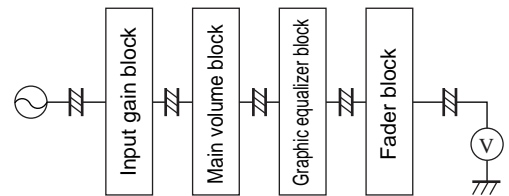
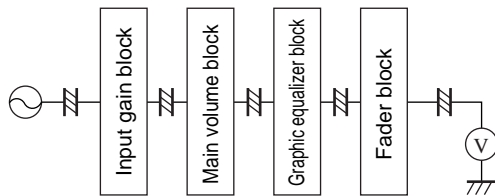
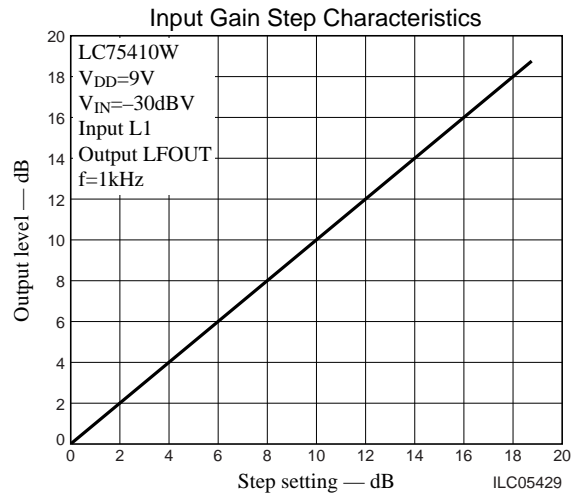
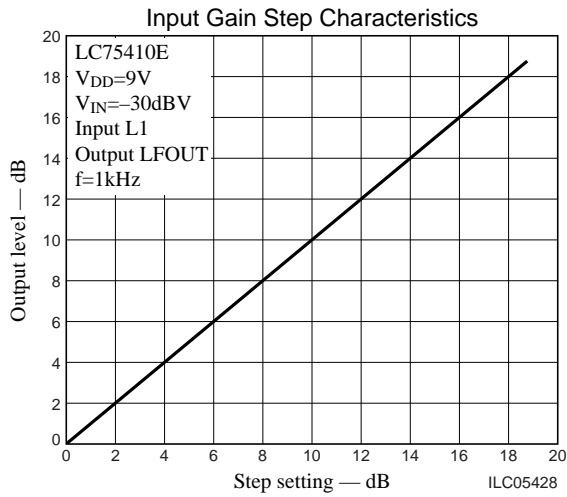
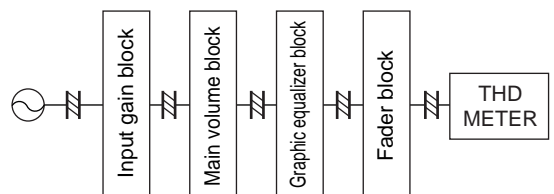
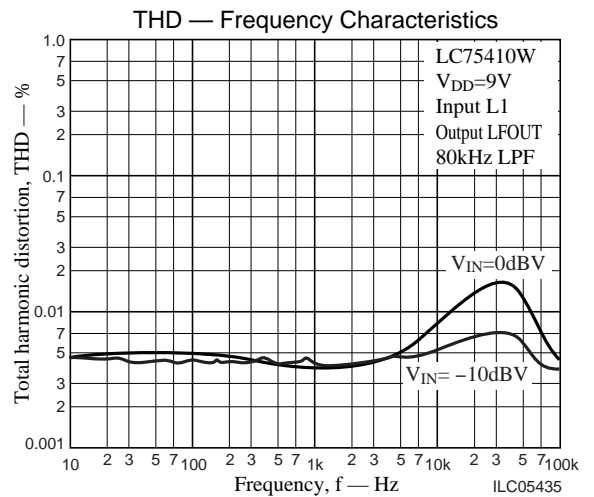
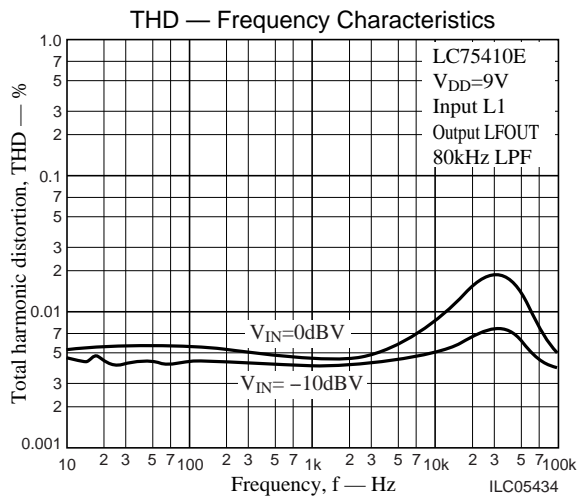
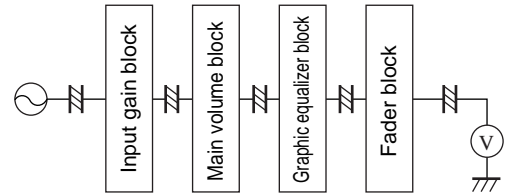
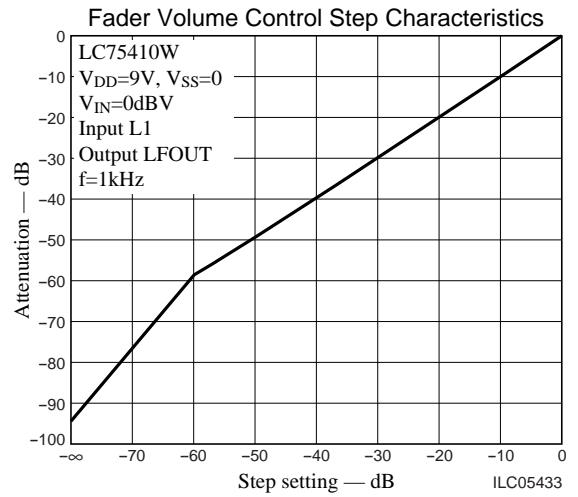
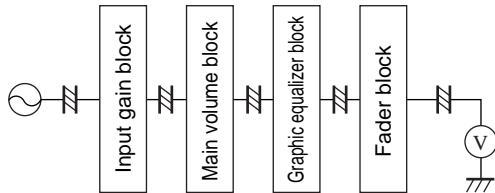
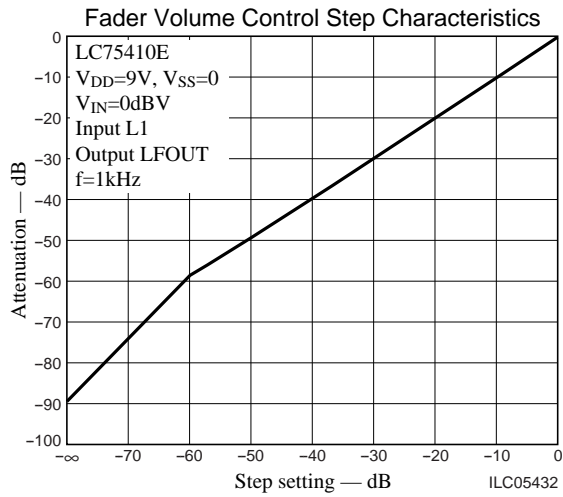
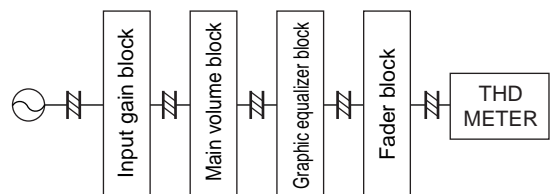
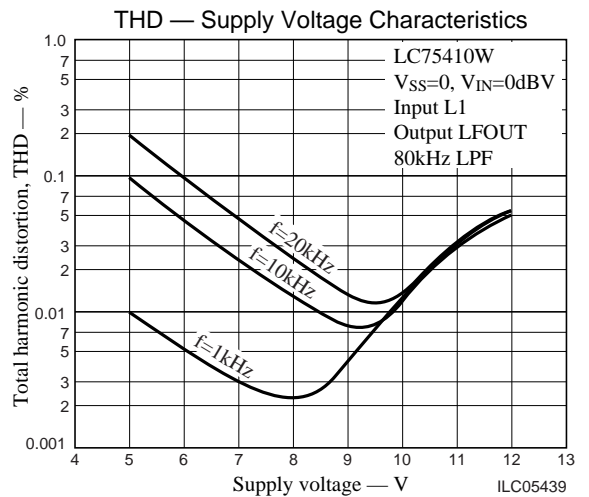
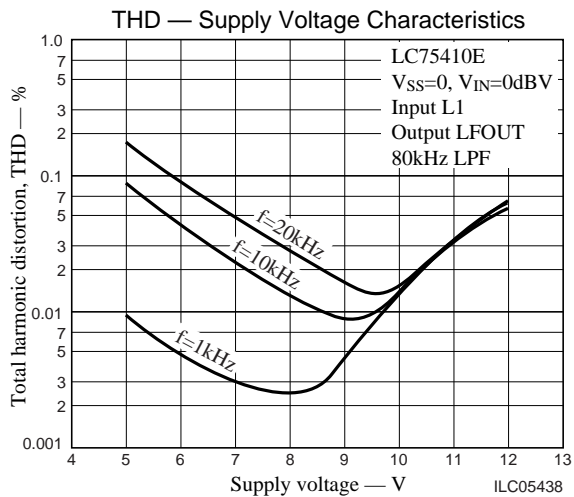
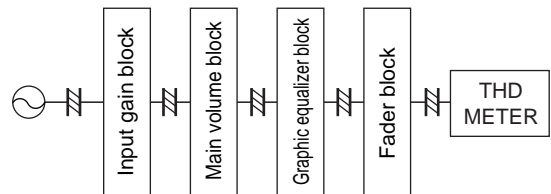
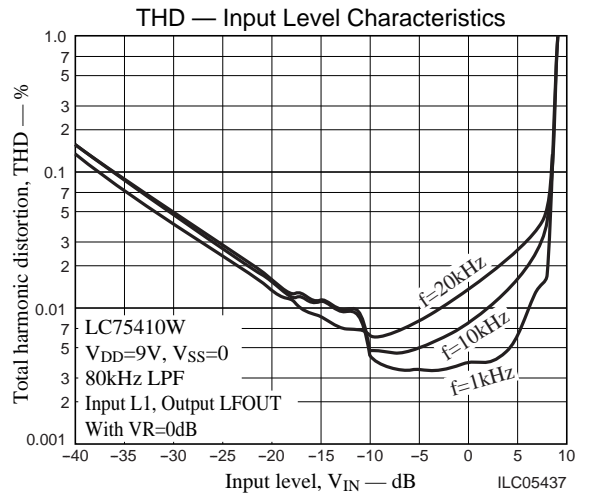
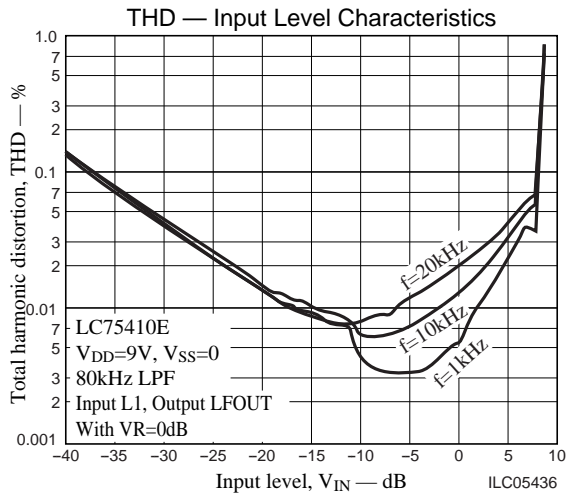

Figure 1









# LC75410E, 75410W

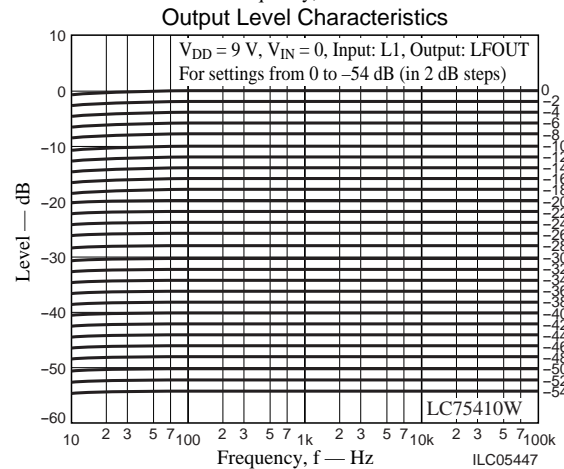
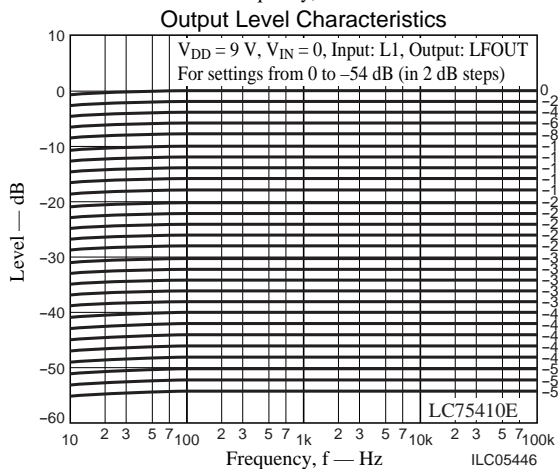
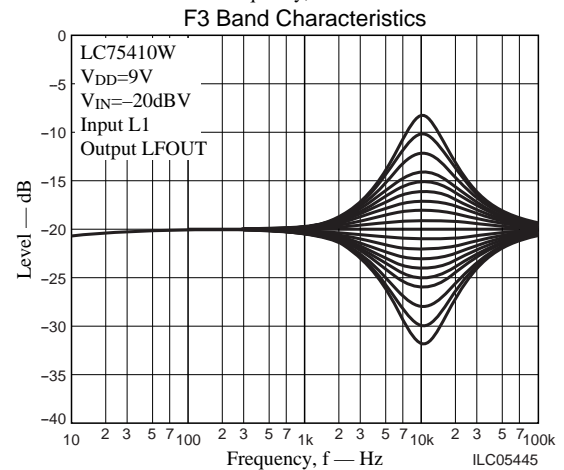
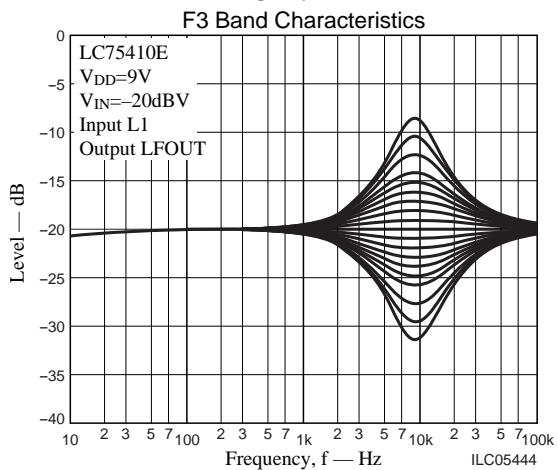
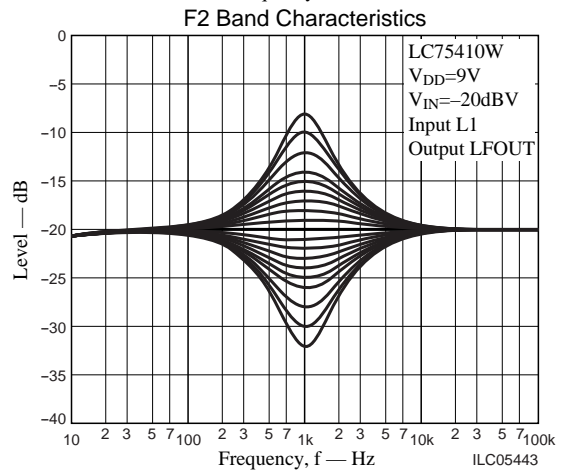
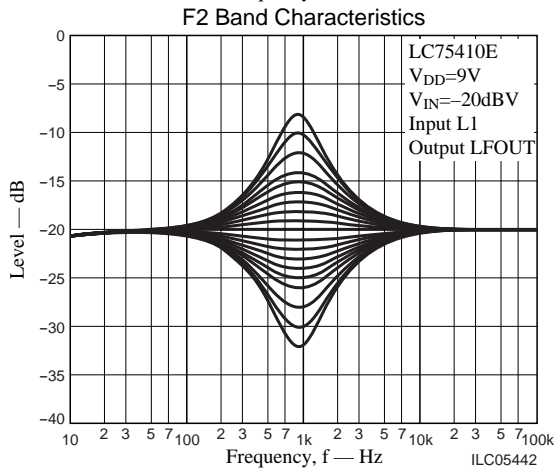
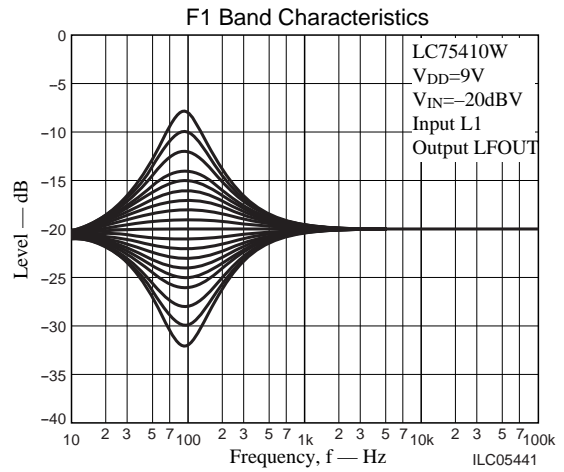
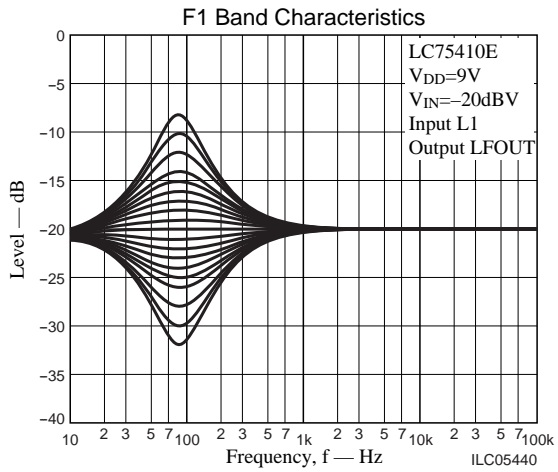

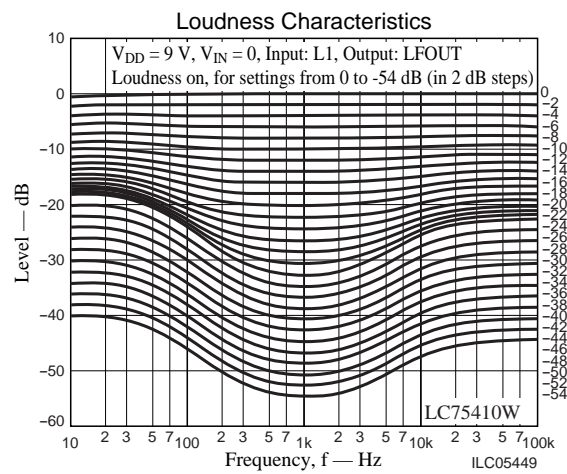
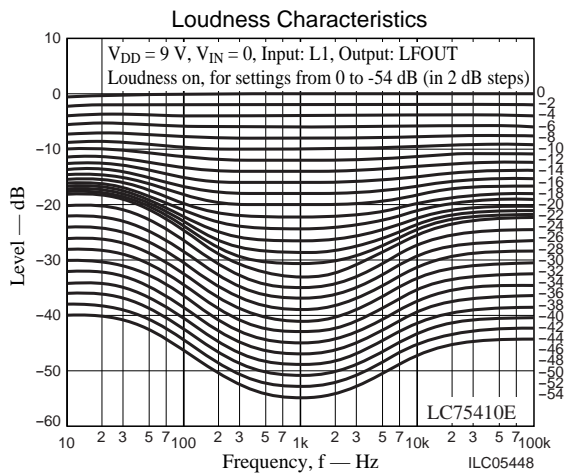

- Specifications of any and all SANYO products described or contained herein stipulate the performance, characteristics, and functions of the described products in the independent state, and are not guarantees of the performance, characteristics, and functions of the described products as mounted in the customer's products or equipment. To verify symptoms and states that cannot be evaluated in an independent device, the customer should always evaluate and test devices mounted in the customer's products or equipment.
- SANYO Electric Co., Ltd. strives to supply high-quality high-reliability products. However, any and all semiconductor products fail with some probability. It is possible that these probabilistic failures could give rise to accidents or events that could endanger human lives, that could give rise to smoke or fire, or that could cause damage to other property. When designing equipment, adopt safety measures so that these kinds of accidents or events cannot occur. Such measures include but are not limited to protective circuits and error prevention circuits for safe design, redundant design, and structural design.
- In the event that any or all SANYO products (including technical data, services) described or contained herein are controlled under any of applicable local export control laws and regulations, such products must not be exported without obtaining the export license from the authorities concerned in accordance with the above law.
- No part of this publication may be reproduced or transmitted in any form or by any means, electronic or mechanical, including photocopying and recording, or any information storage or retrieval system, or otherwise, without the prior written permission of SANYO Electric Co., Ltd.
- Any and all information described or contained herein are subject to change without notice due to product/technology improvement, etc. When designing equipment, refer to the "Delivery Specification" for the SANYO product that you intend to use.
- Information (including circuit diagrams and circuit parameters) herein is for example only; it is not guaranteed for volume production. SANYO believes information herein is accurate and reliable, but no guarantees are made or implied regarding its use or any infringements of intellectual property rights or other rights of third parties.

This catalog provides information as of October, 2001. Specifications and information herein are subject to change without notice.