

M5260L, P, FP

DUAL HIGH-SPEED LOW-NOISE OPERATIONAL AMPLIFIERS (DOUBLE POWER SUPPLY TYPE)

DESCRIPTION

M5260 is a double-power-supply type semiconductor integrated circuit designed for operational amplifiers used in audio equipments (i.e. compact disk players), graphic devices (i.e. video disk players), office automation devices, or general electronic devices. This IC contains two circuits of operational amplifiers which provide the internally phase-compensated high gain, high speed, wide range, low noise characteristics.

This IC has the almost same characteristics as that of 4560 type operational amplifiers and can be used as general dual amplifiers in common electronic devices.

Since this IC can also be used by the single power source and can operate with low supply voltage, it is suitable for general amplifiers in portable equipments. Moreover, large load current can be applied so that it is suitable for headphone amplifiers as well.

FEATURES

- High gain and low distortion $G_{VD} = 110\text{dB}$
THD = 0.0015% (typ.)
- High slew rate, high f_T SR = 4.0V/ μsec
 $f_T = 14\text{MHz}$ (typ.)
- Low noise ($R_S = 1\text{k}\Omega$) FLAT $V_{NI} = 1.8\mu\text{Vrms}$ (typ.)
RIAA $V_{NI} = 0.9\mu\text{Vrms}$ (typ.)
- Operation with low source voltage $V_{CC} \geq 4\text{V} (\pm 2\text{V})$
- High load current, High power dissipation . . $I_{LP} = \pm 50\text{mA}$
 $P_d = 800\text{mW}$ (SIP)
 $P_d = 625\text{mW}$ (DIP)
 $P_d = 440\text{mW}$ (Mini-flat)

APPLICATION

General amplifiers for compact disk units, VCRs, video disk players, or OA equipments and various operational circuits in general electrical devices, servo amplifiers, and active filters

RECOMMENDED OPERATING CONDITIONS

- Supply voltage range $\pm 2 \sim \pm 16\text{V}$
- Rated supply voltage $\pm 15\text{V}$

PIN CONFIGURATION (TOP VIEW)

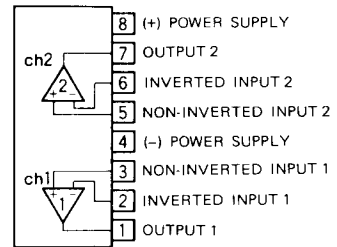

Outline 8P5 (M5260L)

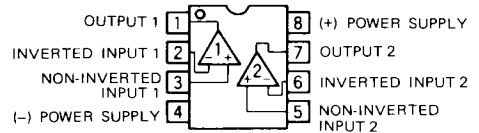

Outline 8P4 (M5260P)
8P2S (M5260FP)

EQUIVALENT CIRCUIT

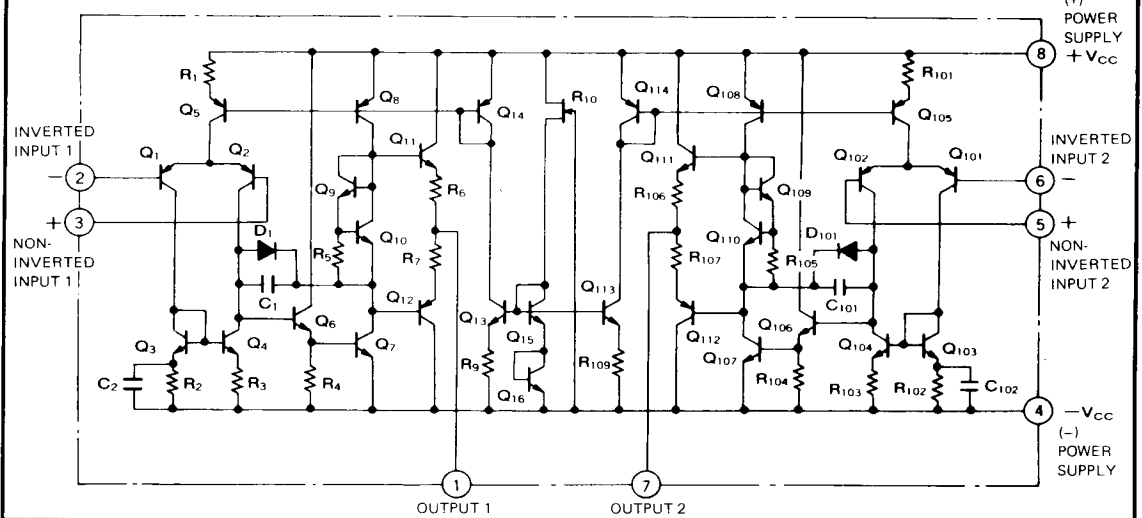

**DUAL HIGH-SPEED LOW-NOISE OPERATIONAL AMPLIFIERS
 (DOUBLE POWER SUPPLY TYPE)**

ABSOLUTE MAXIMUM RATINGS (Ta = 25 °C, otherwise noted)

Symbol	Parameter	Conditions	Ratings	Unit
V _{CC}	Supply voltage		± 18	V
I _{LP}	Load current		± 50	mA
V _{id}	Differential input voltage		± 30	V
V _{iC}	Common input voltage		± 15	V
P _d	Power dissipation		800(SIP)/625(DIP)/440(FP)	mW
K _θ	Thermal derating	Ta ≥ 25 °C	8(SIP)/6.25(DIP)/4.4(FP)	mW/°C
T _{opr}	Operating temperature		- 20 ~ + 75	°C
T _{stg}	Storage temperature		- 55 ~ + 125	°C

ELECTRICAL CHARACTERISTICS (Ta = 25 °C, V_{CC} = ± 15V)

Symbol	Parameter	Test conditions	Limits			Unit
			Min	Typ	Max	
I _{CC}	Circuit current	V _{in} = 0		4.0	8.0	mA
V _{IO}	Input offset voltage	R _S ≤ 10k Ω		0.5	6.0	mV
I _{IO}	Input offset current			5	200	nA
I _{IB}	Input bias current				500	nA
R _{in}	Input resistance		0.3	5		M Ω
G _{VO}	Open loop voltage gain	R _L ≧ 2k Ω, V _O = ± 10V	86	110		dB
V _{OM}	Maximum output voltage	R _L ≧ 10k Ω	± 12	± 14		V
		R _L ≧ 2k Ω	± 10	± 13		
V _{CM}	Common input voltage range		± 12	± 14		V
CMRR	Common mode rejection ratio	R _S ≤ 10k Ω	70	90		dB
SVRR	Supply voltage rejection ratio	R _S ≤ 10k Ω		30	150	μV/V
P _d	Power dissipation			90	180	mW
SR	Slew rate	G _V = 0dB, R _L = 2k Ω		4.0		V/μs
f _T	Gain band width product			14		MHz
V _{NI}	Input-referred noise voltage	R _S = 1k Ω, BW : 10Hz ~ 30kHz		1.8		μVrms

TYPICAL CHARACTERISTICS

THERMAL DERATING (MAXIMUM RATING)

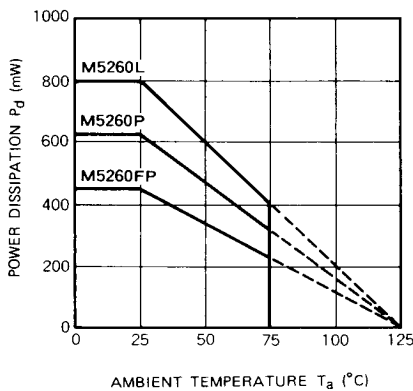

VOLTAGE GAIN VS. FREQUENCY RESPONSE

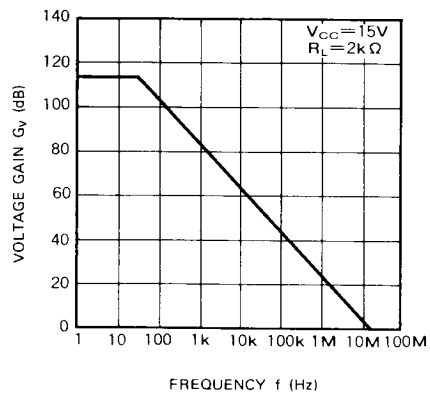

**DUAL HIGH-SPEED LOW-NOISE OPERATIONAL AMPLIFIERS
 (DOUBLE POWER SUPPLY TYPE)**

CIRCUIT CURRENT VS. SUPPLY VOLTAGE

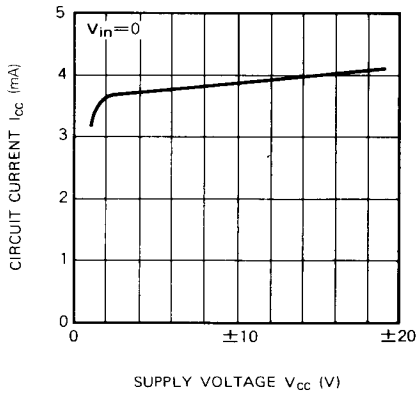

CIRCUIT CURRENT VS. AMBIENT TEMPERATURE

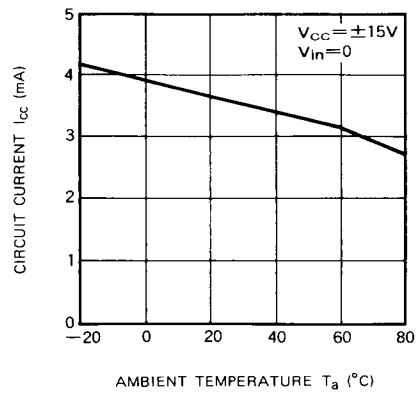

INPUT OFFSET VOLTAGE VS. AMBIENT TEMPERATURE

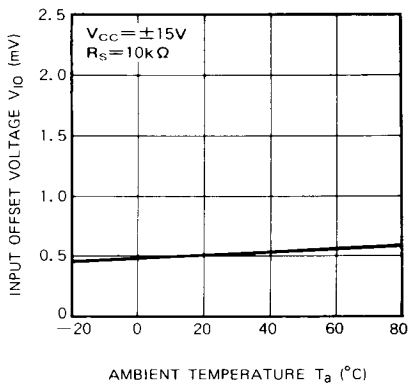

OUTPUT VOLTAGE LOAD CURRENT PEAK VS. LOAD RESISTANCE

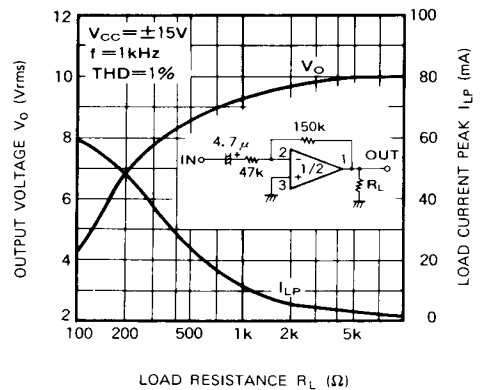

MAXIMUM OUTPUT VOLTAGE VS. SUPPLY VOLTAGE

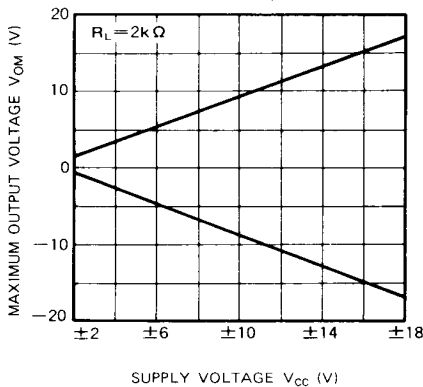

MAXIMUM OUTPUT VOLTAGE VS. FREQUENCY RESPONSE

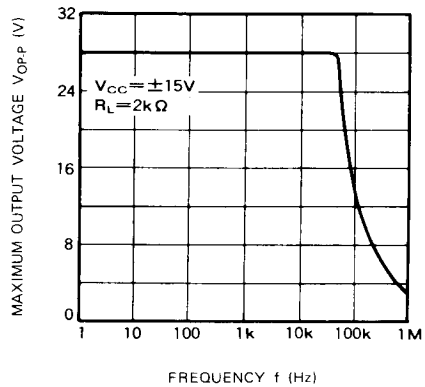

**DUAL HIGH-SPEED LOW-NOISE OPERATIONAL AMPLIFIERS
 (DOUBLE POWER SUPPLY TYPE)**

V_{Ni} , S/N

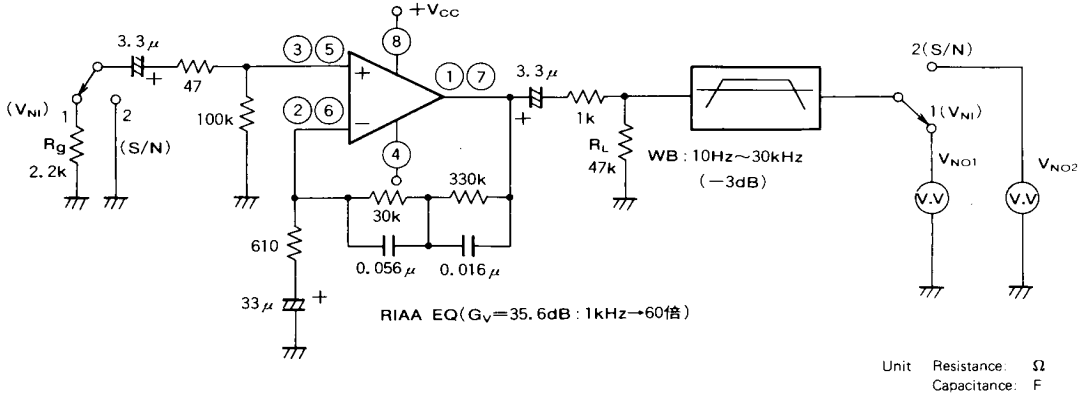

1. $V_{Ni} = V_{NO1} / 60$ [μ Vrms]

2. $S/N = 20 \log(2.5mVrms V_{NO2} / 60)$ [dB]

* A DC voltmeter to be used for the S/N measurement should be the IHF-A network filter (i.e. National noise meter VP-9690) built-in type.

**OUTPUT NOISE VOLTAGE VS.
 SIGNAL SOURCE RESISTANCE**

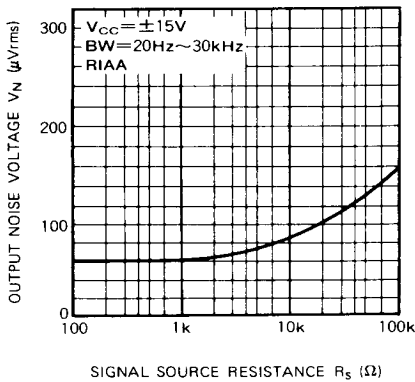

**SIGNAL VS. NOISE VOLTAGE RATIO
 VERSUS SIGNAL SOURCE RESISTANCE**

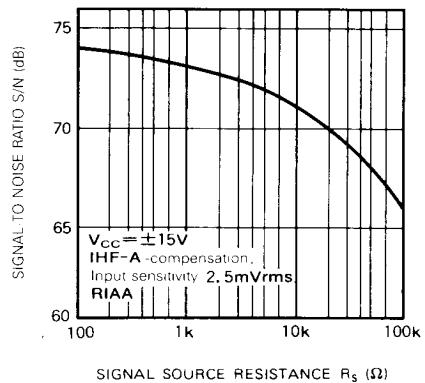

**DUAL HIGH-SPEED LOW-NOISE OPERATIONAL AMPLIFIERS
 (DOUBLE POWER SUPPLY TYPE)**

About the RIAA (Record Industry Association of America)

In case that any sound is recorded on a record disk, long wave length (low tone) may exceeds the width of the ditch of the record so that the wave length becomes more longer, the amplitude should be more compressed. Also, since higher frequency elements will be picked up more as the noise by the record needle, the SN ratio will be increased

in recording sound such that when the frequency becomes higher, the more emphasis is applied (preemphasis). Therefore, when you play a record you will need an equalizer circuit, which provides the opposite frequency characteristics to the recording characteristics, to obtain flat output.

STEREO EQUALIZER AMPLIFIER CIRCUIT

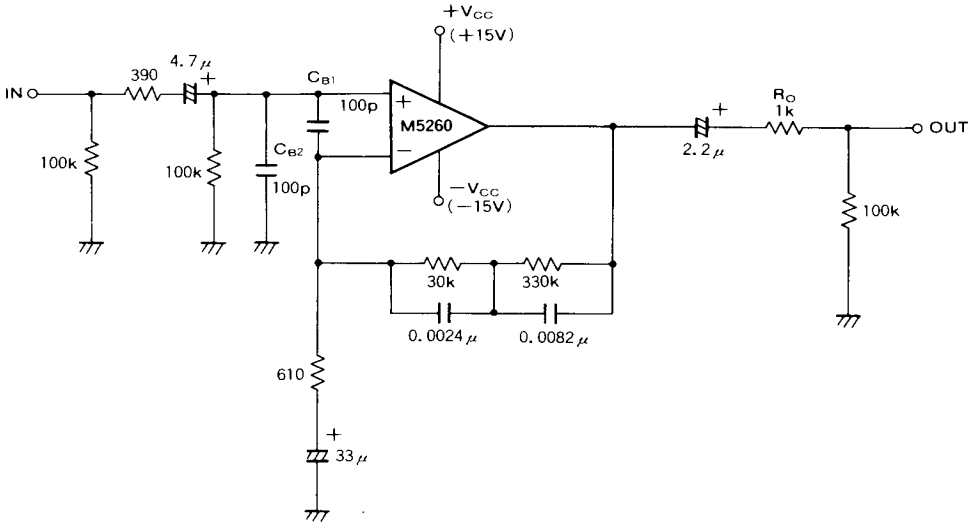

The circuit constant of L_{ch} is the same as that of R_{ch} .
 C_{B1} , C_{B2} : Capacitor for handling buzz. Use them if necessary.
 R_O : Resistor used for controlling the current in case of abnormal current flow (i.e. short circuit at load end) or for preventing the parasitic oscillation for the capacitance load.

Typical characteristics ($V_{cc} = \pm 15V$, RIAA)

- $G_v = 35.6dB$ ($f = 1kHz$)
- $V_{N1} = 1\mu Vrms$ ($R_s = 1k\Omega$, $BW = 20Hz$ to $30kHz$)
- $S/N = 74.0dB$ (IHF-A compensation, input short, input sensitivity $2.5mVrms$)
- $THD = 0.0015\%$ ($f = 1kHz$, $V_o = 3Vrms$)

**TOTAL HARMONIC DISTORTION
 VS. OUTPUT VOLTAGE**

