

ASSP

# 2-Channel 8-BIT D/A Converter

## MB40968/40968V

### ■ DESCRIPTION

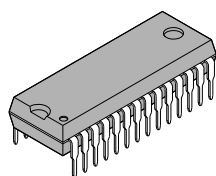
The Fujitsu MB40968/40968V is a 2-channel 8-bit high speed digital to analog converter for video frequency band fabricated by Fujitsu Advanced Bipolar Technology. This is suitable for YC signal processing of digital VCR.

### ■ FEATURES

- Resolution: 8-bits
- Linearity error:  $\pm 0.2\%$  (max.)
- Maximum conversion rate: 30 MHz (Min.)
- Analog output voltage range: 3 to 5V
- Reference voltage output:
  - MB40968: Resistance-type potential divider output ( $3/5 \times V_{CCA}$ )
  - MB40968V: Band gap reference output ( $V_{CCA} - 2$  [V])
- Digital input voltage: TTL level
- Single power supply voltage: +5.0 [V]
- Power dissipation: 270 [mW] (typ)

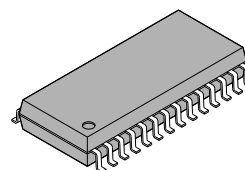
### ■ PACKAGE

Plastic DIP, 28 pin



(DIP-28P-M03)

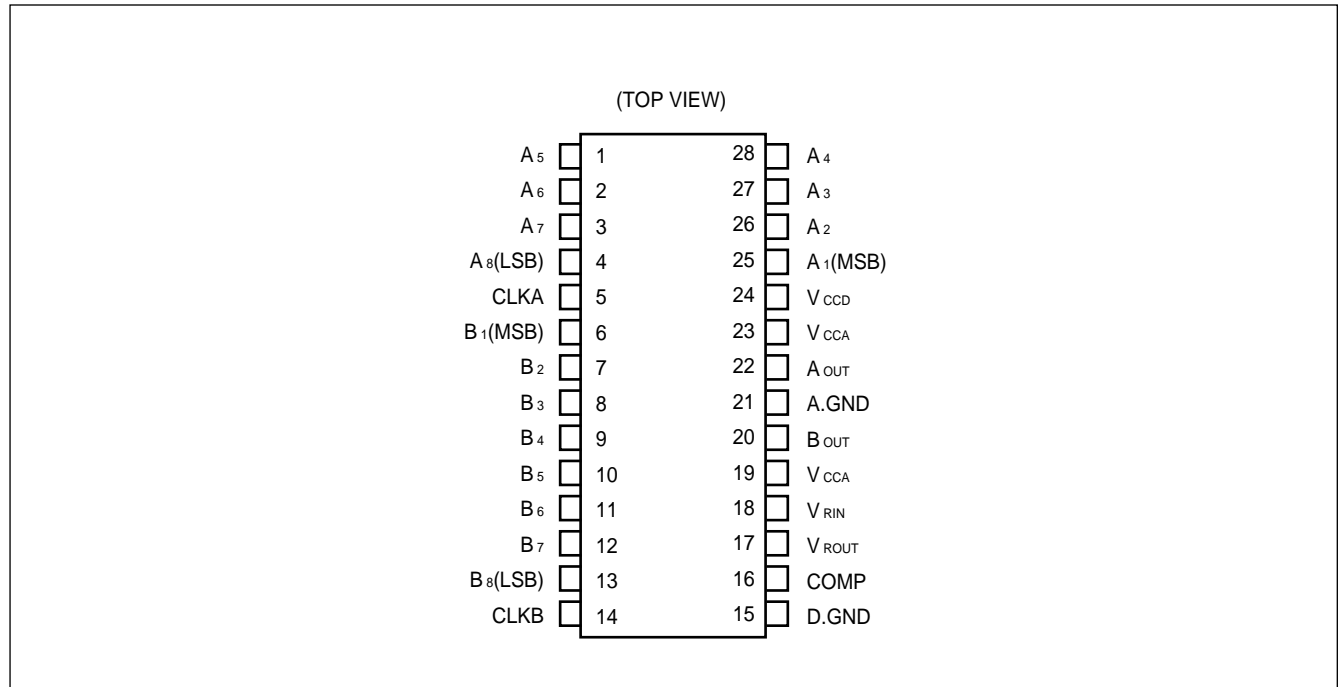
Plastic FTP, 28 pin



(FTP-28P-M01)

# MB40968/40968V

## ■ PIN ASSIGNMENT

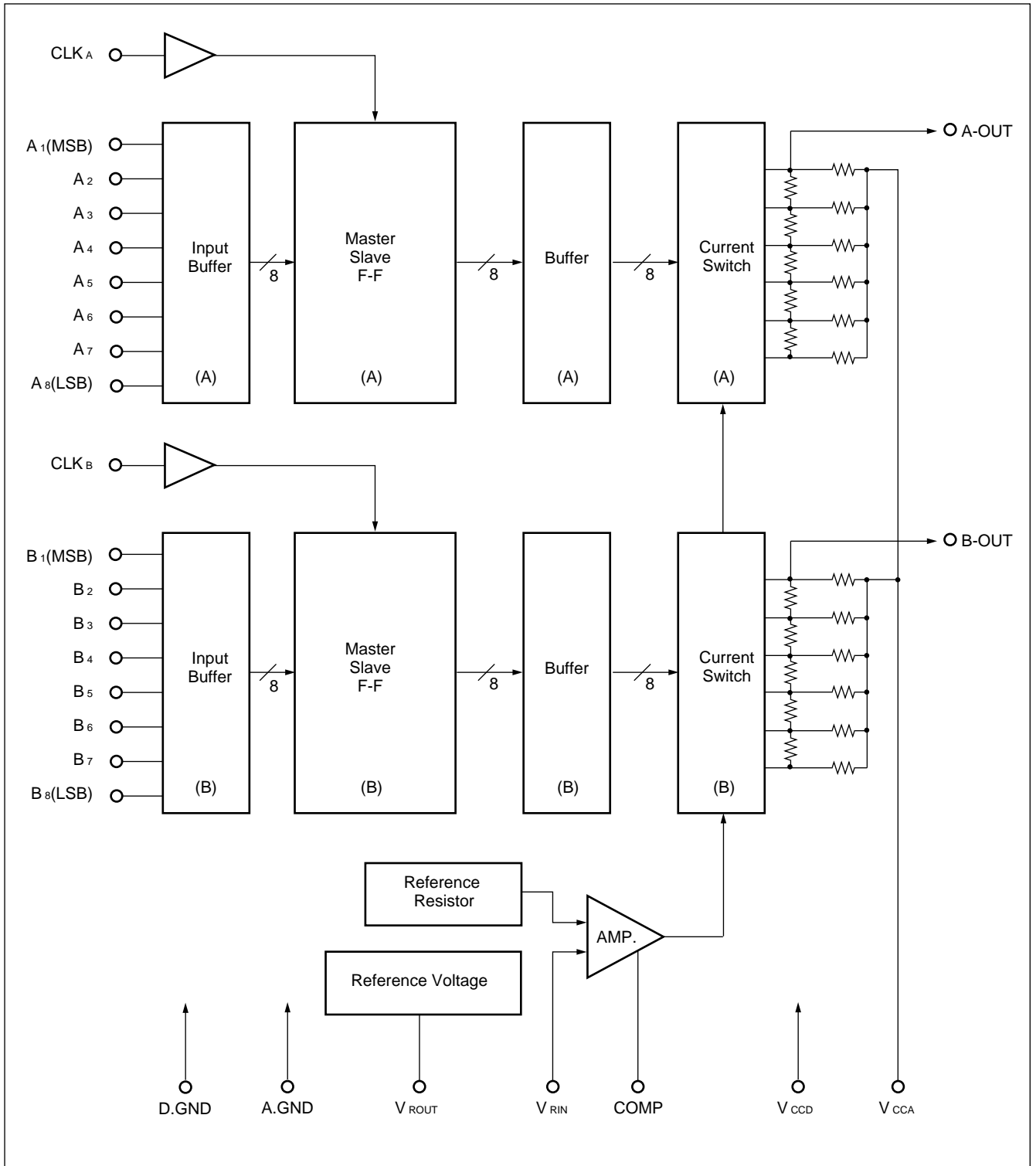


## ■ PIN DESCRIPTION

Pin Number	Symbol	I/O	Descriptions
25 to 28 1 to 4	A <sub>1</sub> TO A <sub>8</sub>	I	A-channel Digital Signal Inputs: A <sub>1</sub> (MSB), A <sub>8</sub> (LSB)
6 to 13	B <sub>1</sub> to B <sub>8</sub>	I	B- channel Digital Signal Inputs: B <sub>1</sub> (MSB), B <sub>8</sub> (LSB)
5	CLK <sub>A</sub>	I	A-channel Clock Input
14	CLK <sub>B</sub>	I	B-channel Clock Input
24	V <sub>CCD</sub>	—	Power Supply for Digital Circuit
19, 23	V <sub>CCA</sub>	—	Power Supply for Analog Circuit, two pins (19,23) should be used.
15	D-GND	—	Ground for Digital Circuit
21	A-GND	—	Ground for Analog Circuit
18	V <sub>RIN</sub>	I	Terminal for reference voltage input. Zero scale voltage of analog output is specified applying any voltage to this terminal. Input reference voltage should be 2.7 to 4.3V and, $V_{CCA} - V_{RIN} \leq 2.2V$
17	MB40968 V <sub>ROUT</sub>	O	Terminal for reference voltage output by resistance-type potential divider. Analog output of " $V_{CCA}$ to $3/5 \times V_{CCA}$ " is supplied connecting this terminal with V <sub>RIN</sub> terminal.
	MB40968 V <sub>ROUT</sub>	O	Terminal for reference voltage output consists of Band Gap reference. This terminal supplies the voltage of " $V_{CCA} - V_{CCA} - 2V$ ". 2V output is maintained connecting this terminal with V <sub>RIN</sub> , even if the power supply fluctuates frequently.
16	COMP	—	Terminal for phase compensation capacitance; Capacitance of 1 $\mu$ F or more should be inserted between COMP and A-GND.
22	A <sub>OUT</sub>	O	A-channel Analog Signal Output
20	B <sub>OUT</sub>	O	B-channel Analog Signal Output

# MB40968/40968V

## ■ BLOCK DIAGRAM



## ■ ABSOLUTE MAXIMUM RATINGS

Rating	Symbol	Value	Unit
Power supply voltage	$V_{CCA}, V_{CCD}$	-0.5 to +7.0	V
Supply voltage difference	$V_{CCD} - V_{CCA}$	1.5	V
Digital input voltage	$V_{ID}$	-0.5 to +7.0	V
Storage temperature	$T_{STG}$	-55 to +125	°C

Precautions: Permanent device damage may occur if the above Absolute Maximum Ratings are exceeded. Functional operation should be restricted to the conditions as detailed in the operational sections of this data sheet. Exposure to absolute maximum rating conditions for extended periods may affect device reliability.

## ■ RECOMMENDED OPERATING CONDITIONS

Parameter	Symbol	Value			Unit
		Min.	Typ.	Max.	
Power supply voltage	$V_{CCA}, V_{CCD}$ ( $V_{CCA} - V_{CCD}$ )	4.75 (-0.2)	5.00	5.25 (0.2)	V
Analog reference voltage	$V_{CCA} - V_{RIN}$	0.70	2.00	2.20	V
	$V_{RIN}$	2.70	3.00	4.30	
High level digital Input voltage	$V_{IHD}$	2.0	—	—	V
Low level digital input voltage	$V_{ILD}$	—	—	0.8	V
Clock frequency	$f_{CLK}$	—	—	30	MHz
Data set up time	$t_{SU}$	10.0	—	—	ns
Data hold time	$t_h$	4.0	—	—	ns
High level clock pulse width	$t_{WH}$	10.0	—	—	ns
Low level clock pulse width	$t_{WL}$	10.0	—	—	ns
Phase compensation capacitance	$C_{COMP}$	1.0	—	—	μF
Operating temperature	$T_{op}$	0	—	70	°C

# MB40968/40968V

## ■ ELECTRICAL CHARACTERISTICS

(V<sub>CC</sub> = 4.75 to 5.25V, T<sub>a</sub> = 0 to 70°C)

Parameter	Symbol	Condition	Value			Unit
			Min.	Typ.	Max.	
Resolution	—	—	—	—	8	Bit
Linearity error	LE	DC	—	—	±0.2	%
Reference input current	I <sub>RIN</sub>	V <sub>RIN</sub> = 3.000 (V)	—	—	10	μA
High level digital input current	I <sub>IND</sub>	V <sub>IND</sub> = 2.7 (V)	—	—	20	μA
Low level digital input current	I <sub>ILD</sub>	V <sub>ILD</sub> = 0.4 (V)	-100	—	—	μA
2-channel's output voltage ratio	FSR	V <sub>CCA</sub> = 5.00 (V) V <sub>CCD</sub> = 5.00 (V) V <sub>RIN</sub> = V <sub>ROUT</sub>	0	—	4	%
Full-scale analog output voltage	V <sub>OFS</sub>	V <sub>CCA</sub> = 5.00 (V) V <sub>CCD</sub> = 5.00 (V) V <sub>RIN</sub> = V <sub>ROUT</sub>	V <sub>CCA</sub> -0.015	V <sub>CCA</sub>	—	V
Zero-scale analog output voltage	V <sub>OZS</sub>	V <sub>CCA</sub> = 5.00 (V) V <sub>CCD</sub> = 5.00 (V) V <sub>RIN</sub> = 3.000 (V)	2.938	3.008	3.078	V
Output resistance	R <sub>O</sub>	T <sub>a</sub> = 25°C	192	240	288	Ω
Power supply current	I <sub>CC</sub>	V <sub>CCA</sub> = 5.00 (V) V <sub>CCD</sub> = 5.00 (V) V <sub>RIN</sub> = V <sub>ROUT</sub>	—	54*	80	mA

\* : V<sub>CC</sub> = 5.00 (V)

### MB40968

Reference output voltage	V <sub>ROUT</sub>	V <sub>CCA</sub> = 5.00 (V) V <sub>CCD</sub> = 5.00 (V)	2.900	3.000	3.100	V
--------------------------	-------------------	--	-------	-------	-------	---

### MB40968V

Reference output voltage	V <sub>ROUT</sub>	—	V <sub>CCA</sub> -2.100	V <sub>CCA</sub> -2.000	V <sub>CCA</sub> -1.900	V
Reference output voltage temperature constant	—	—	—	100	—	ppm/°C

## Switching Characteristics

(V<sub>CC</sub> = 4.75 to 5.25V, T<sub>a</sub> = 0 to 70°C)

Parameter	Symbol	Condition	Value			Unit
			Min.	Typ.	Max.	
Minimum conversion rate	F <sub>s</sub>	—	30	—	—	MSPS
Output delay time	t <sub>PLH</sub> t <sub>PHL</sub>	C <sub>L</sub> = 15 pF	—	10	—	ns
Output rise time	t <sub>r</sub>	Terminated A.OUT pin with 240Ω	—	5	—	ns
Output fall time	t <sub>f</sub>		—	5	—	ns
Settling time	t <sub>setLH</sub> t <sub>setHL</sub>	Terminated B.OUT pin with 240Ω	—	15	—	ns

Figure 1 DAC Output Voltage

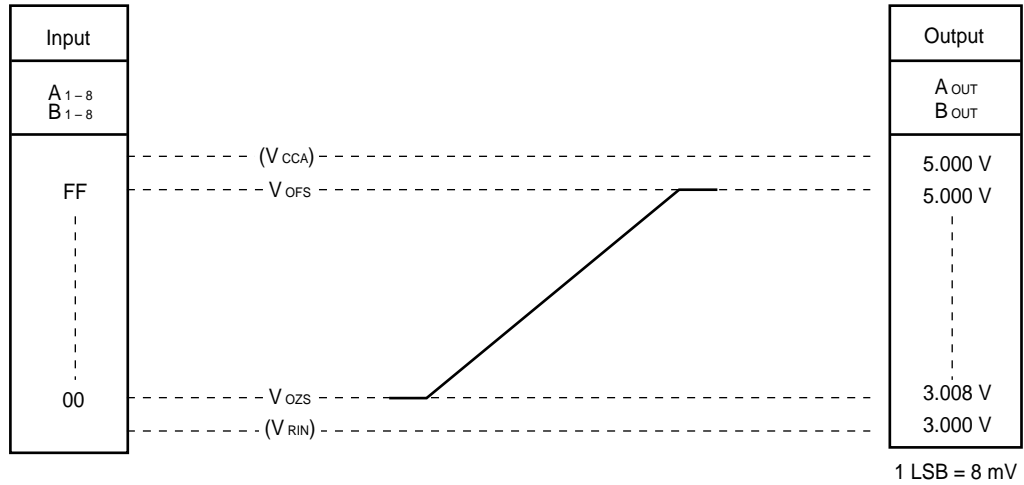
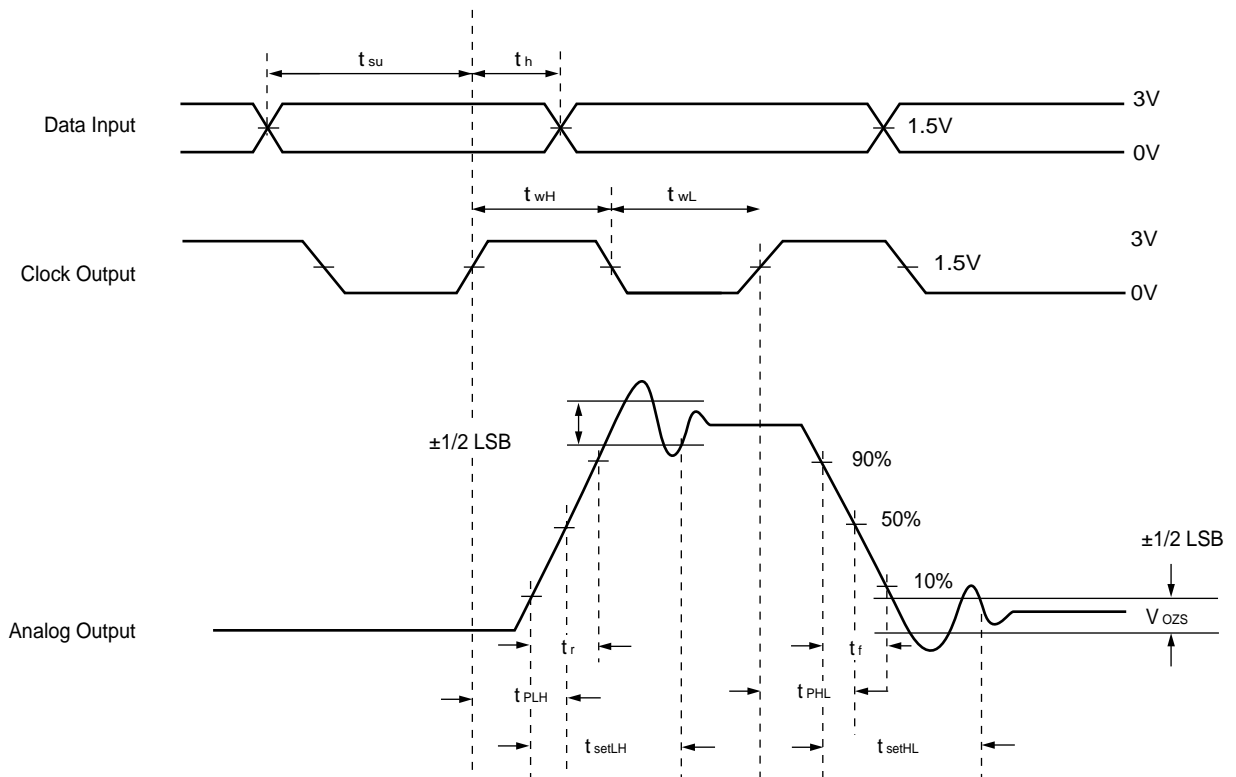
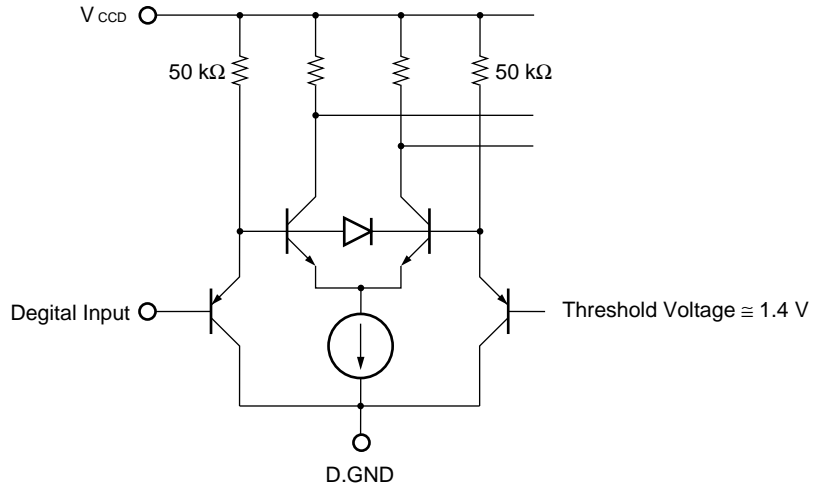


Figure 2 Timing Diagram

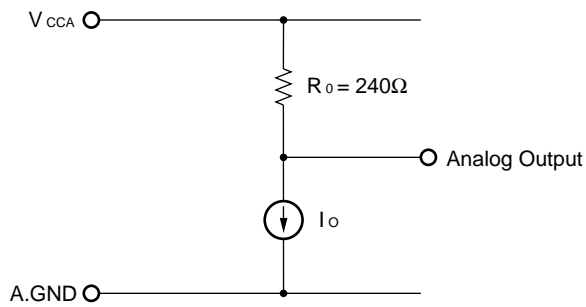


# MB40968/40968V

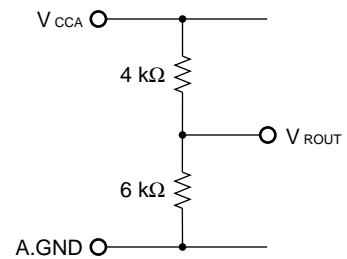
**Figure 3 Digital Input Equivalent Circuit (A<sub>1</sub> to A<sub>8</sub>, B<sub>1</sub> to B<sub>8</sub>, CLK<sub>A</sub>, CLK<sub>B</sub>)**



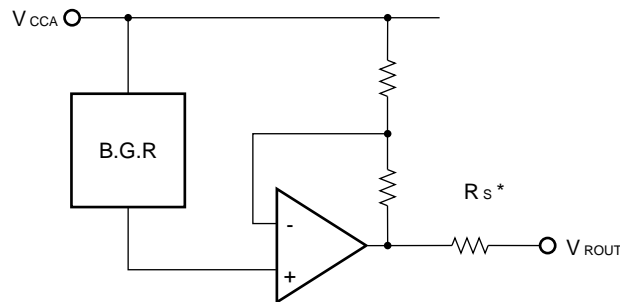
**Figure 4 Analog Output Equivalent Circuit (A<sub>OUT</sub>, B<sub>OUT</sub>)**



**Figure 5 MB40968 Reference Output Voltage (V<sub>ROUT</sub>)**



**Figure 6 MB40968V Reference Output Voltage (V<sub>ROUT</sub>)**



Note\*: Reference for preventing over current when short circuit with GND.



The relations between Digital input code and Analog output voltage of MB40968/40968V are ideally indicated as follows.

$$AOUT_N(BOUT_N) = V_{CCA} - \frac{255 - N}{256} \times (V_{CCA} - V_{RIN}) \quad N: 0 \text{ to } 255 \text{ Digital Input Code}$$

$$VOFS = V_{CCA}$$

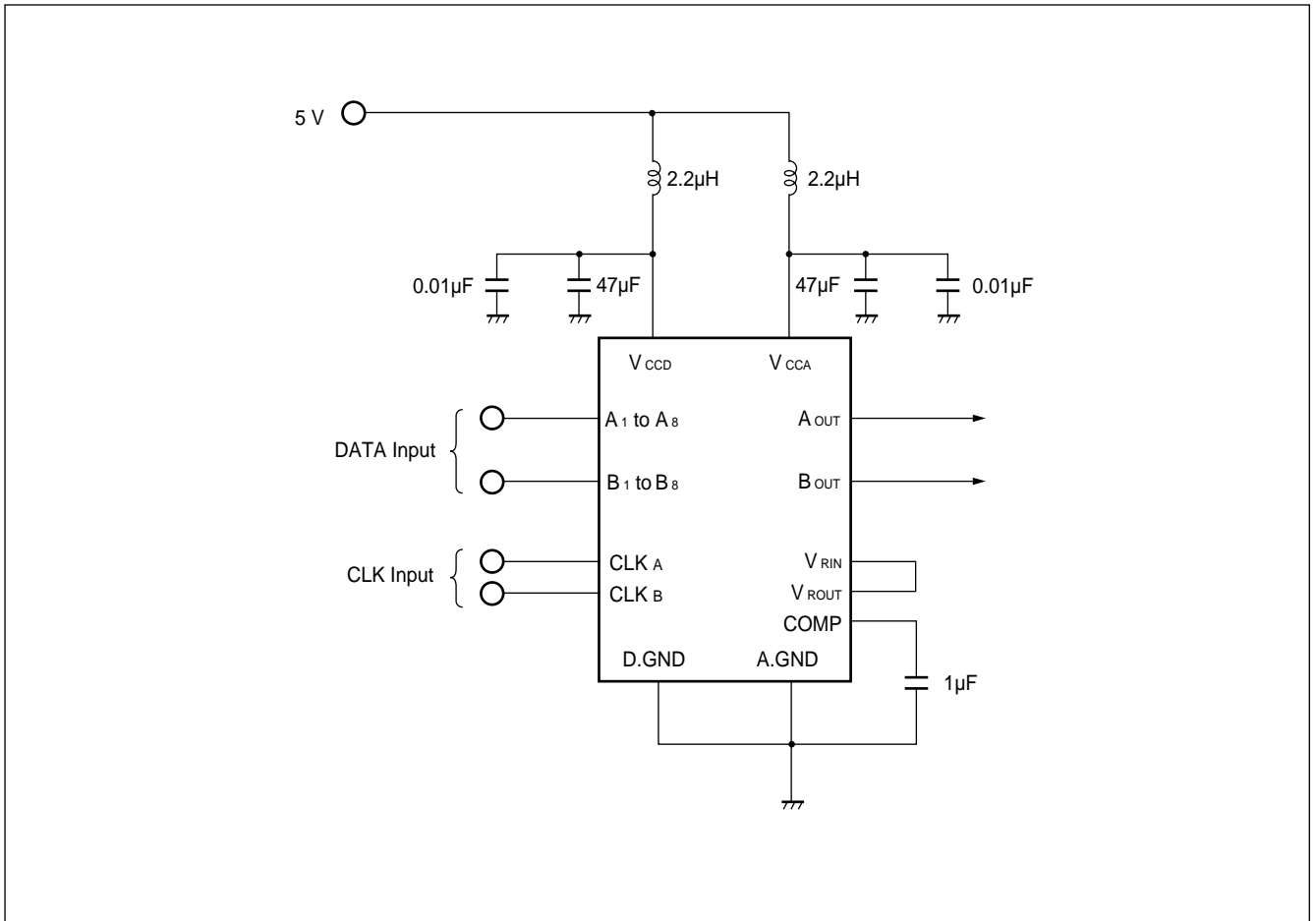
$$VOZS = V_{CCA} - \frac{255}{256} \times (V_{CCA} - V_{RIN})$$

Output Voltage Ratio between 2 channels is calculated as follows.

$$FSR = \left[ \frac{VOFS(A) - VOZS(A)}{VOFS(B) - VOZS(B)} - 1 \right] \times 100\%$$

# MB40968/40968V

## ■ TYPICAL CONNECTION EXAMPLE



## ■ PRECAUTIONS

### 1. Inter-channel Crosstalk

The MB88361 is a 2-channel D/A converter, requiring the use of special mounting methods to minimize crosstalk between analog output pins.

Specifically, it is recommended that PC board designs should emphasize the prevention of large coupling capacities between analog output lines. (See ■TYPICAL CHARACTERISTIC CURVES.)

### 2. Prevention of Switching Noise

To reduce superimposed switching noise on the analog output signal to an absolute minimum, it is recommended that a noise limiting capacitor between the  $V_{CCA}$  and  $V_{CCD}$  pins be placed as close as possible to the pins and connected to the A.GND and D.GND pins.

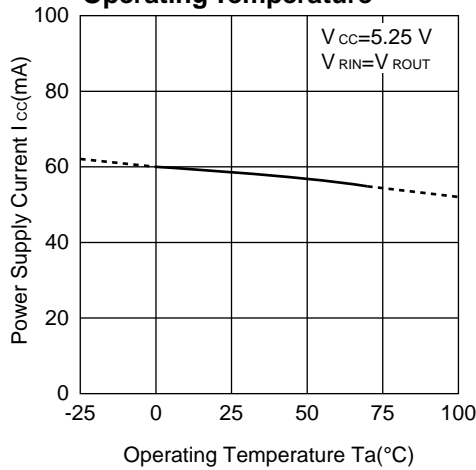
### 3. Power Supply Patterns

Power supply patterns connected to the A.GND and B.GND pins should be as possible in order to reduce parasitic impedance.

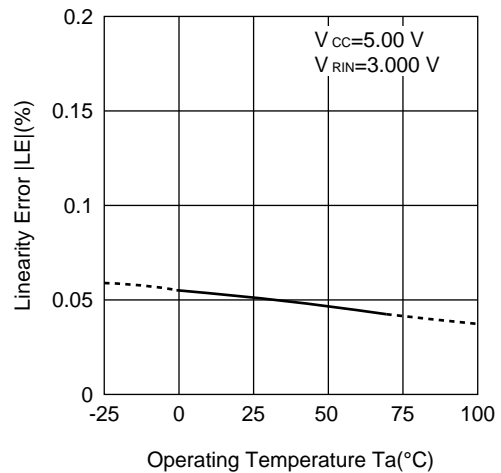
# MB40968/40968V

## TYPICAL CHARACTERISTIC CURVES

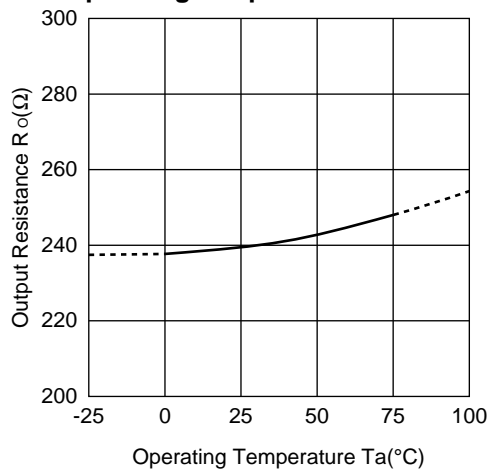
**Figure 7 Power Supply Current vs. Operating Temperature**



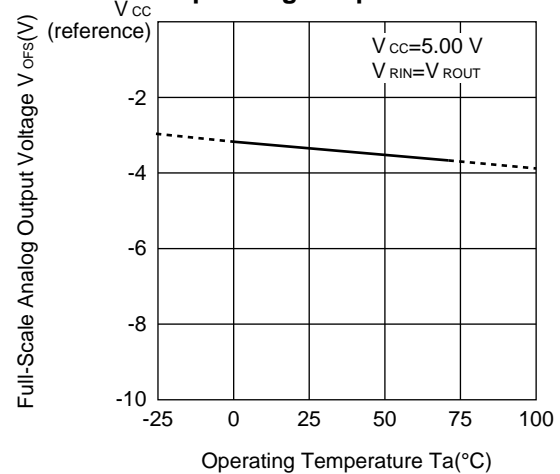
**Figure 8 Linearity Error vs. Operating Temperature**



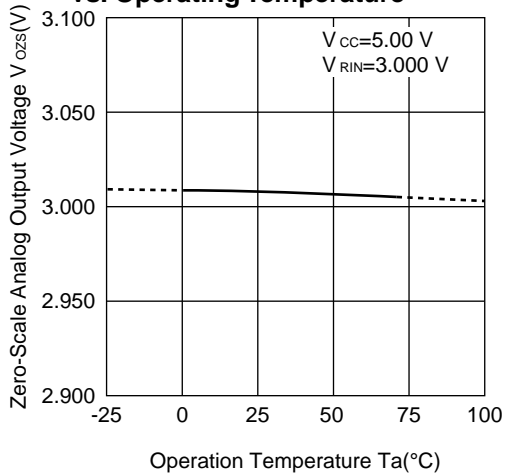
**Figure 9 Output Resistance vs. Operating Temperature**



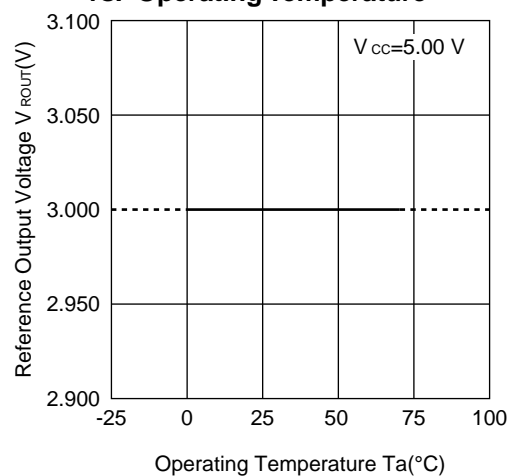
**Figure 10 Full-Scale Analog Output Voltage vs. Operating Temperature**



**Figure 11 Zero-Scale Analog Output Voltage vs. Operating Temperature**

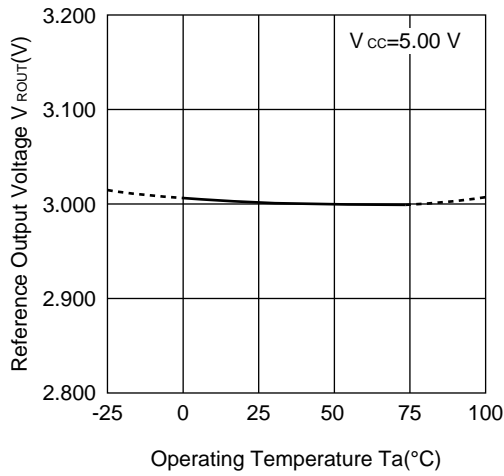


**Figure 12 MB40968 Reference Output Voltage vs. Operating Temperature**

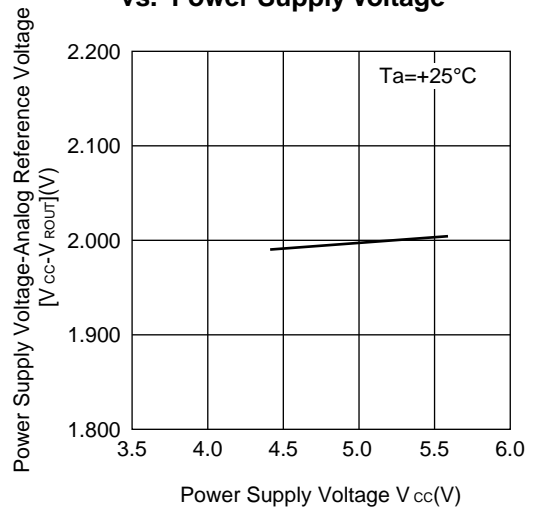


(Continued)

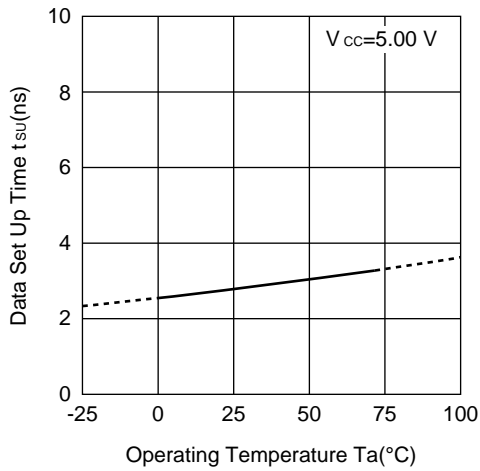
**Figure 13 MB40968V Reference Output Voltage vs. Operating Temperature**



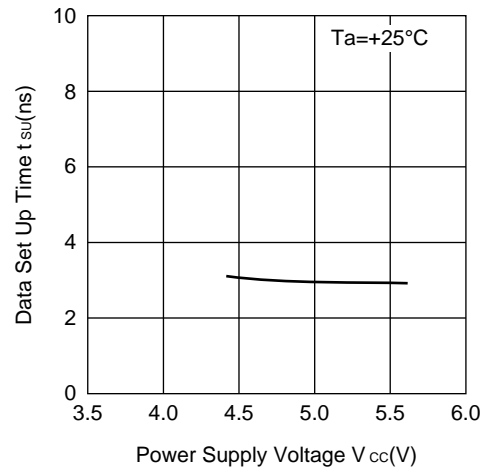
**Figure 14 MB40968V Analog Reference Voltage vs. Power Supply Voltage**



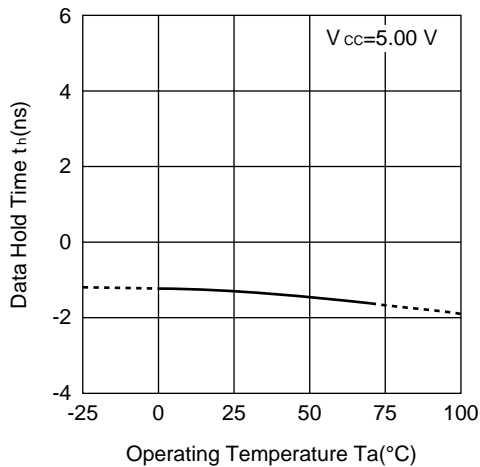
**Figure 15 Data Set Up Time vs. Operating Temperature**



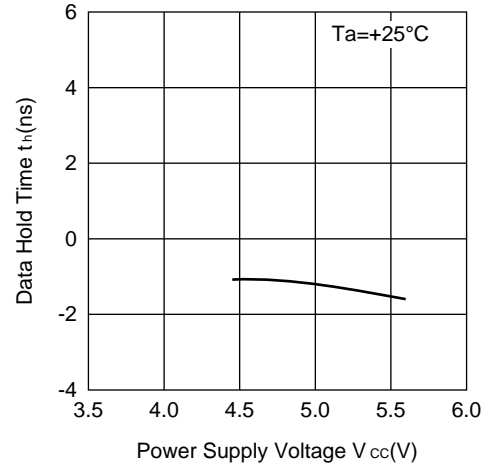
**Figure 16 Data Set Up Time vs. Power Supply Voltage**



**Figure 17 Data Hold Time vs. Operating Temperature**



**Figure 18 Data Hold Time vs. Power Supply Voltage**

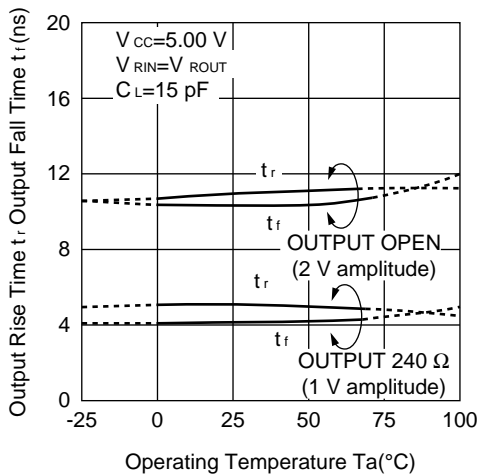


(Continued)

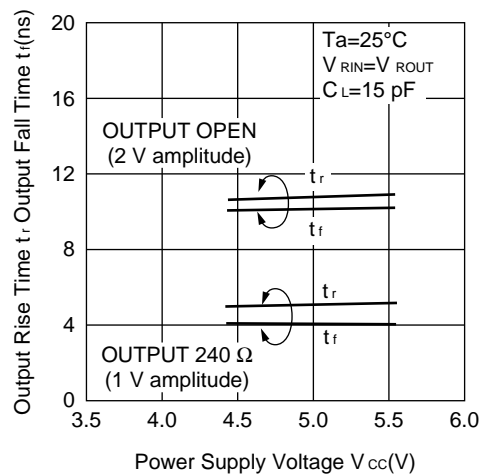
# MB40968/40968V

(Continued)

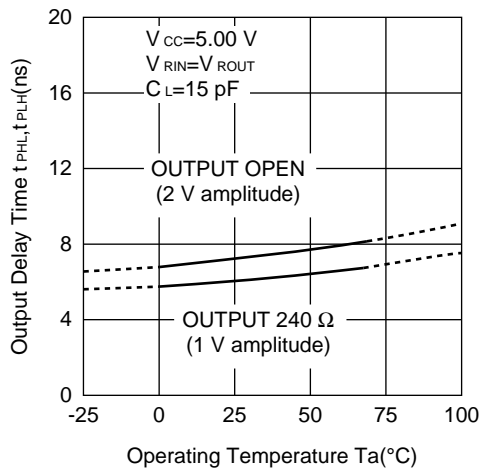
**Figure 19 Output Rise, Fall Time vs. Operating Temperature**



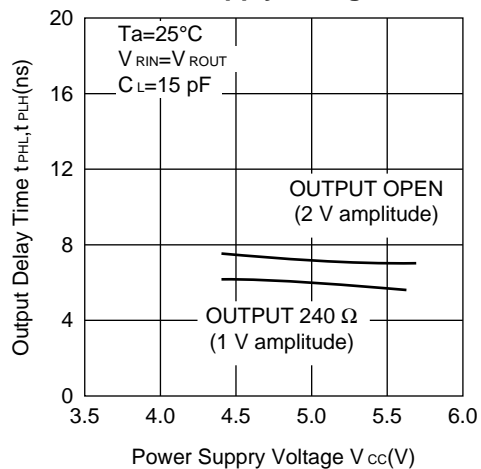
**Figure 20 Output Rise, Fall Time vs. Power Supply Voltage**



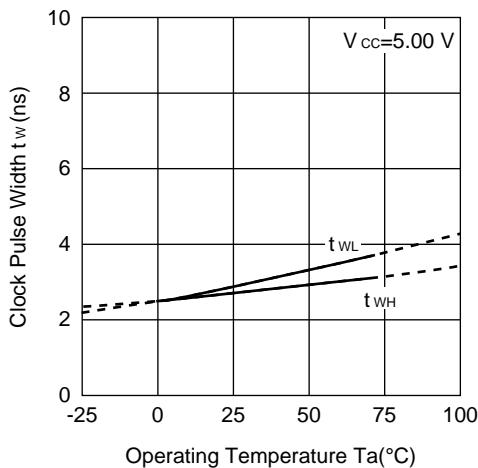
**Figure 21 Output Delay Time vs. Operating Temperature**



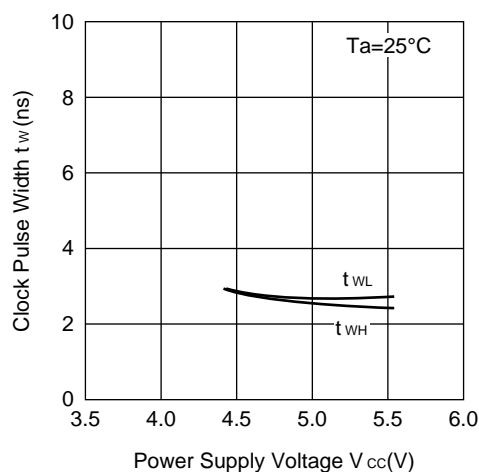
**Figure 22 Output Delay Time vs. Power Supply Voltage**



**Figure 23 Clock Pulse Width vs. Operating Temperature**



**Figure 24 Clock Pulse Width vs. Power Supply Voltage**

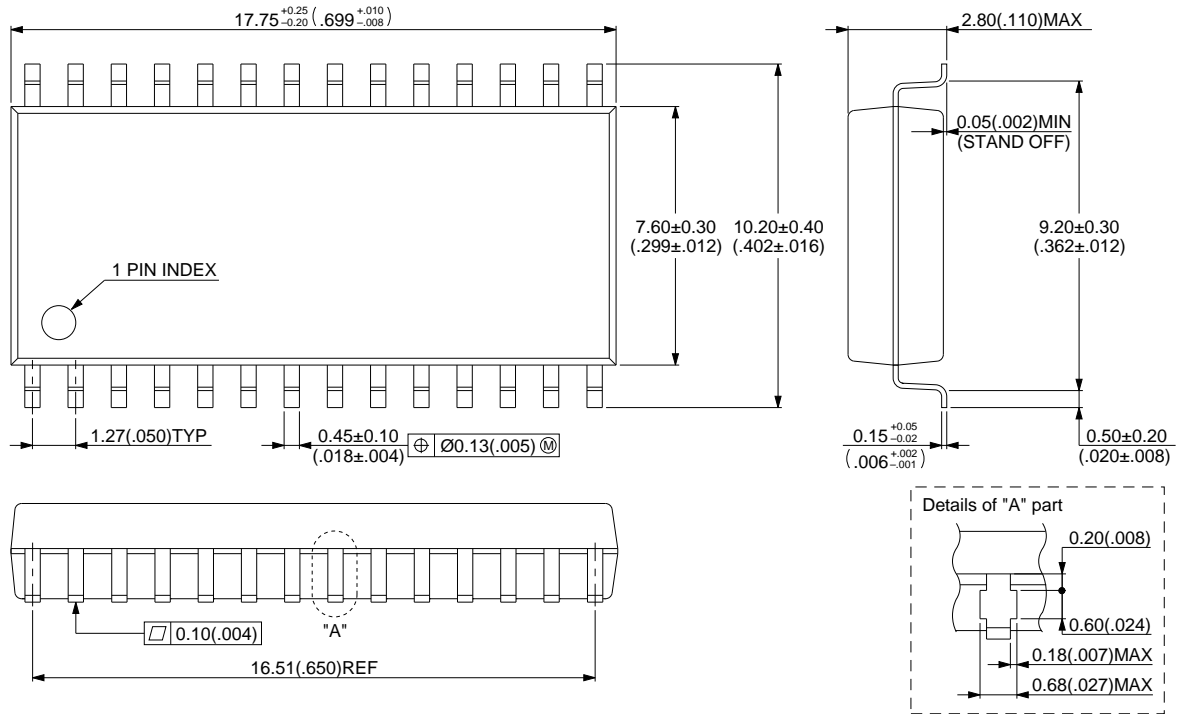




# MB40968/40968V

(Continued)

28 pin, Plastic SOP  
(FTP-28P-M01)



© 1994 FUJITSU LIMITED F28005S-5C-4

Dimensions in mm (inches).



# FUJITSU LIMITED

*For further information please contact:*

## **Japan**

FUJITSU LIMITED  
Corporate Global Business Support Division  
Electronic Devices  
KAWASAKI PLANT, 4-1-1, Kamikodanaka  
Nakahara-ku, Kawasaki-shi  
Kanagawa 211-88, Japan  
Tel: (044) 754-3763  
Fax: (044) 754-3329

## **North and South America**

FUJITSU MICROELECTRONICS, INC.  
Semiconductor Division  
3545 North First Street  
San Jose, CA 95134-1804, U.S.A.  
Tel: (408) 922-9000  
Fax: (408) 432-9044/9045

## **Europe**

FUJITSU MIKROELEKTRONIK GmbH  
Am Siebenstein 6-10  
63303 Dreieich-Buchsschlag  
Germany  
Tel: (06103) 690-0  
Fax: (06103) 690-122

## **Asia Pacific**

FUJITSU MICROELECTRONICS ASIA PTE. LIMITED  
#05-08, 151 Lorong Chuan  
New Tech Park  
Singapore 556741  
Tel: (65) 281-0770  
Fax: (65) 281-0220

All Rights Reserved.

The contents of this document are subject to change without notice. Customers are advised to consult with FUJITSU sales representatives before ordering.

The information and circuit diagrams in this document presented as examples of semiconductor device applications, and are not intended to be incorporated in devices for actual use. Also, FUJITSU is unable to assume responsibility for infringement of any patent rights or other rights of third parties arising from the use of this information or circuit diagrams.

FUJITSU semiconductor devices are intended for use in standard applications (computers, office automation and other office equipment, industrial, communications, and measurement equipment, personal or household devices, etc.).

### **CAUTION:**

Customers considering the use of our products in special applications where failure or abnormal operation may directly affect human lives or cause physical injury or property damage, or where extremely high levels of reliability are demanded (such as aerospace systems, atomic energy controls, sea floor repeaters, vehicle operating controls, medical devices for life support, etc.) are requested to consult with FUJITSU sales representatives before such use. The company will not be responsible for damages arising from such use without prior approval.

Any semiconductor devices have inherently a certain rate of failure. You must protect against injury, damage or loss from such failures by incorporating safety design measures into your facility and equipment such as redundancy, fire protection, and prevention of over-current levels and other abnormal operating conditions.

If any products described in this document represent goods or technologies subject to certain restrictions on export under the Foreign Exchange and Foreign Trade Control Law of Japan, the prior authorization by Japanese government should be required for export of those products from Japan.