

MN3205

4096-STAGE LOW VOLTAGE OPERATION LOW NOISE BBD

General description

The MN3205 is a 4096-stage low voltage operation ($V_{DD} = 5V$) BBD that provides a signal delay of up to 204.8ms at clock frequency 10KHz and is suitable for use as reverberation effect of audio equipments such as portable stereo and radio cassette recorders which need low voltage and long delay time since S/N is 67dB in spite of many stages.

Features

- Variable delay of audio signals: 20.48ms ~ 204.8ms.
- Wide power supply voltage: 4 ~ 9V.
- No insertion loss: $L_i = 0dB$ typ.
- Wide dynamic range: $S/N = 67dB$ typ.
- N channel silicon gate process.
- Special 8-Lead Dual-In-Line Plastic Package.

Applications

- Reverberation and echo effects of audio equipment such as radio cassette recorder, car radio, portable radio, portable stereo, echo microphone and pre-taped musical accompaniment (Karaoke), etc.
- Sound effect of electronic musical instruments.
- Variable or fixed delay of analog signals.
- Telephone time compression and delay line for voice communication system.

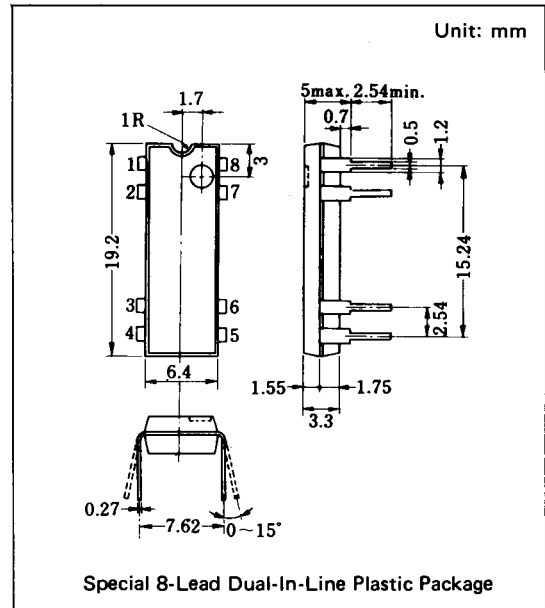

Block Diagram

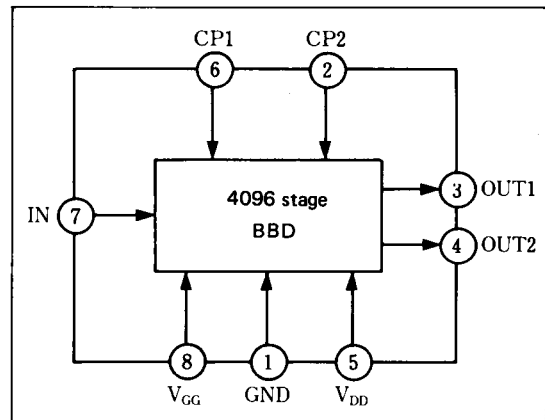

Quick Reference Data

Item	Symbol	Value	Unit
Supply Voltage	V_{DD}, V_{GG}	+ 5, $\frac{1}{3} V_{DD}$	V
Signal Delay Time	t_D	20.48~204.8	ms
Total Harmonic Distortion	THD	0.8	%
Signal to Noise Ratio	S/N	67	dB

■ Absolute Maximum Ratings (Ta = 25°C)

Item	Symbol	Rating	Unit
Terminal Voltage	V _{DD} , V _{GG} , V _{CP} , V _i	-0.3~+11	V
Output Voltage	V _o	-0.3~+11	V
Operating Ambient Temperature	T _{opr}	-20~+60	°C
Storage Temperature	T _{stg}	-55~+125	°C

■ Operating Condition (Ta = 25°C)

Item	Symbol	Condition	Min.	Typ.	Max.	Unit
Drain Supply Voltage	V _{DD}		+4	+5	+9	V
Gate Supply Voltage	V _{GG}			$\frac{14}{15}V_{DD}$		V
Clock Voltage "H" Level	V _{CPH}			V _{DD}		V
Clock Voltage "L" Level	V _{CPL}		0		+0.5	V
Clock Frequency	f _{CP}		10		100	kHz
Clock Pulse Width *1	t _{CPW}				0.5T *2	
Clock Rise Time *1	t _{CPr}				500	ns
Clock Fall Time *1	t _{CPf}				500	ns
Clock Input Capacitance	C _{CP}				2800	pF
Clock Cross Point *1	V _X		0		0.3V _{CPH}	V

■ Electrical Characteristics (Ta = 25°C, V_{DD} = V_{CPH} = 5V, V_{CPL} = 0V, V_{GG} = 14/15 V_{DD}, R_L = 100kΩ)

Item	Symbol	Condition	Min.	Typ.	Max.	Unit
Signal Delay Time	t _D		20.48		204.8	ms
Input Signal frequency	f _i	f _{CP} = 40kHz, Output Attenuation ≤ 3dB	6			kHz
Input Signal Swing	V _i	THD=2.5%	0.36			V _{rms}
Insertion Loss	L _i	f _{CP} =40kHz, f _i =1kHz	-4	0	4	dB
Total Harmonic Distortion	THD	f _{CP} =40kHz, f _i =1kHz, V _i =0.25V _{rms}		0.8	2.5	%
Output Noise Voltage	V _{no}	f _{CP} = 100kHz, Weighted by "A" curve			0.35	mV _{rms}
Signal to Noise Ratio	S/N			67		dB

*1 Clock Pulse Waveforms

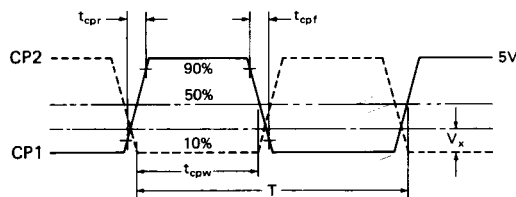

*2 T = 1/f_{CP} (Clock Period)

■ Terminal Assignments

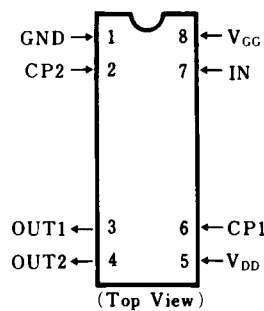

■ Circuit Diagram

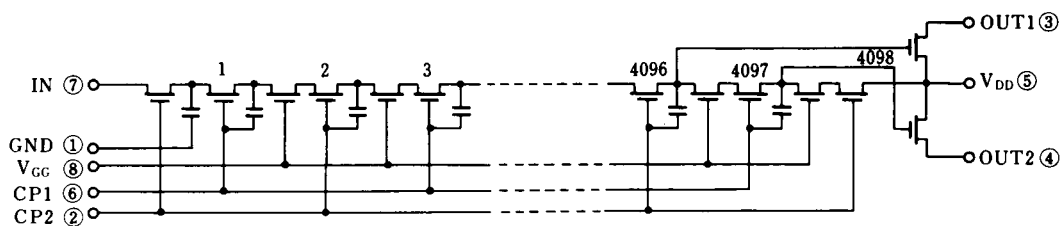

Typical Electrical Characteristic Curves

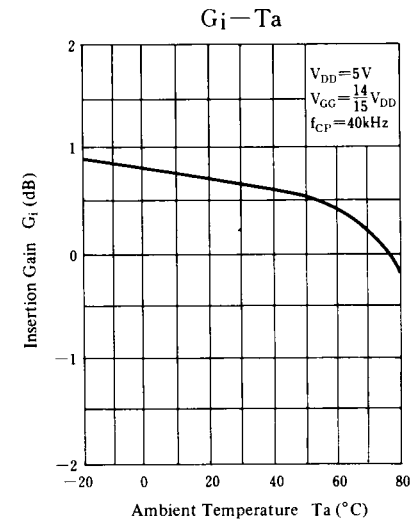
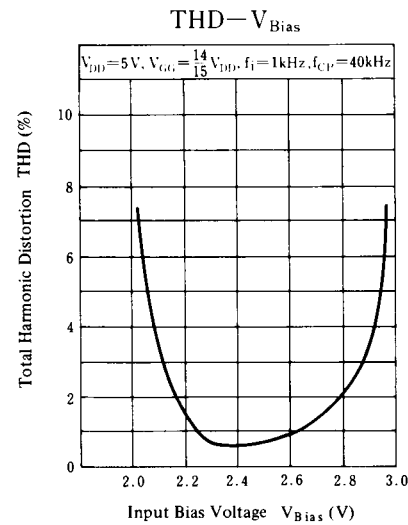
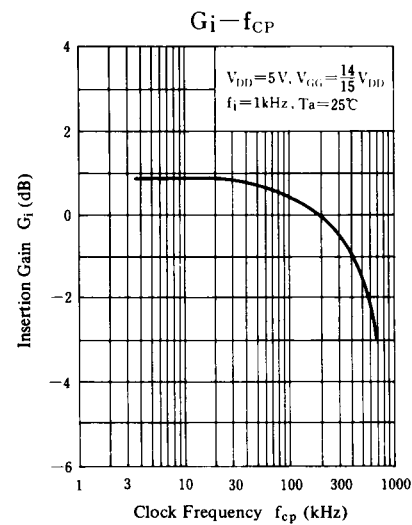
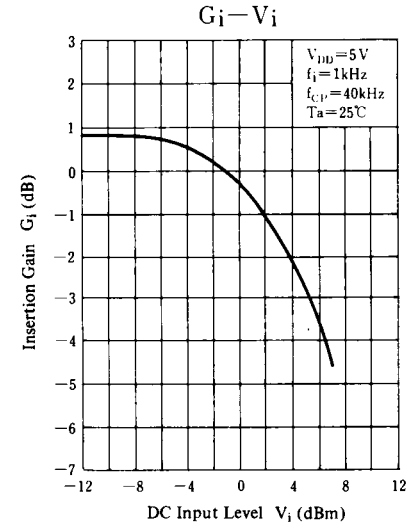
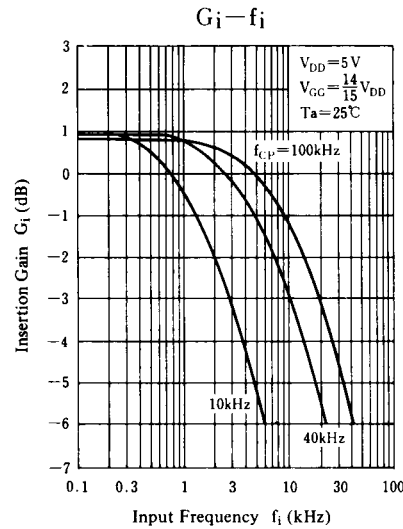
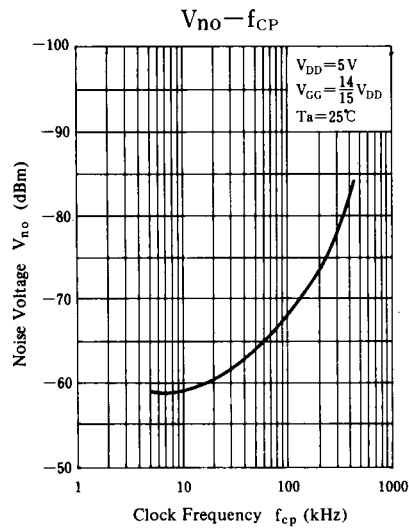
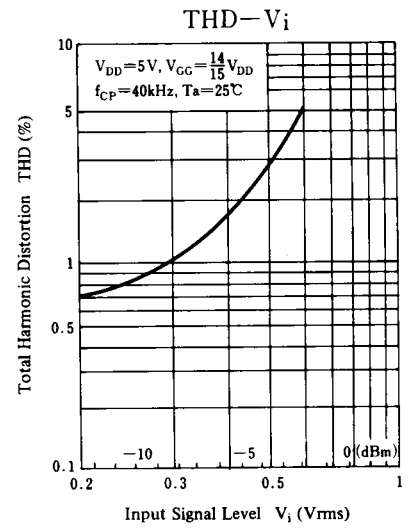
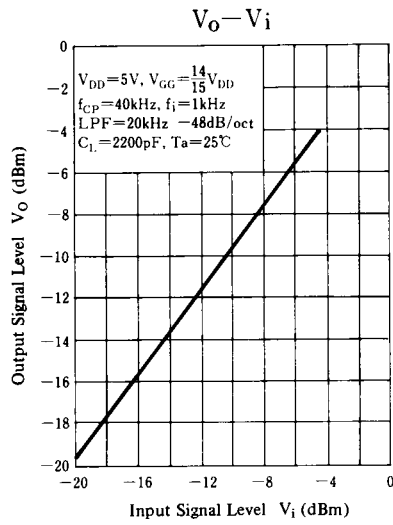
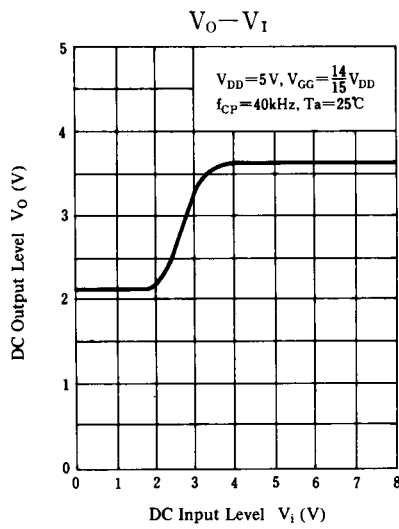

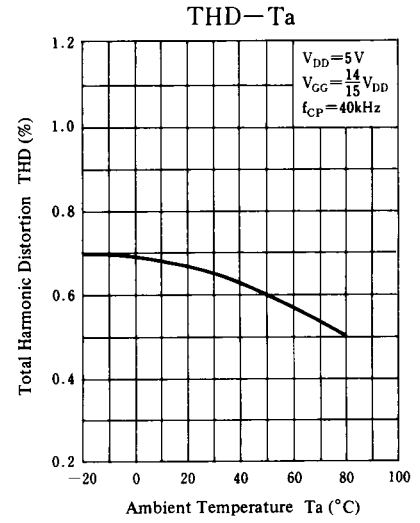
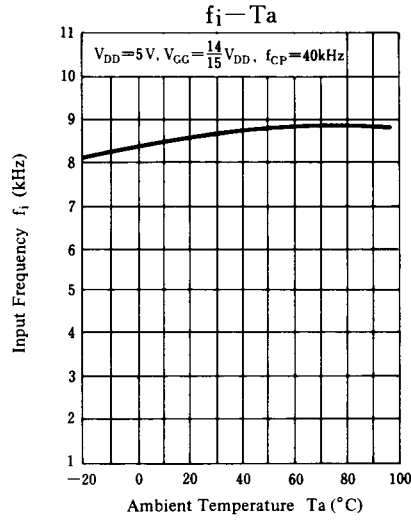
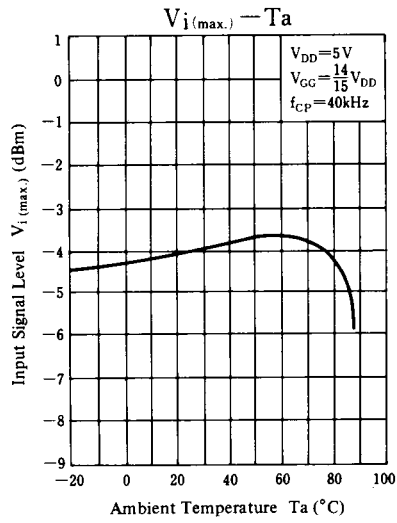

Supply Voltage Characteristics

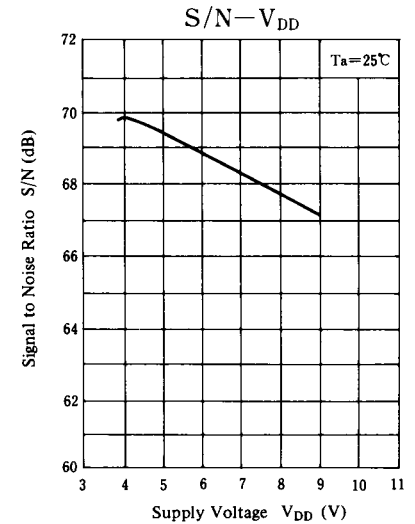
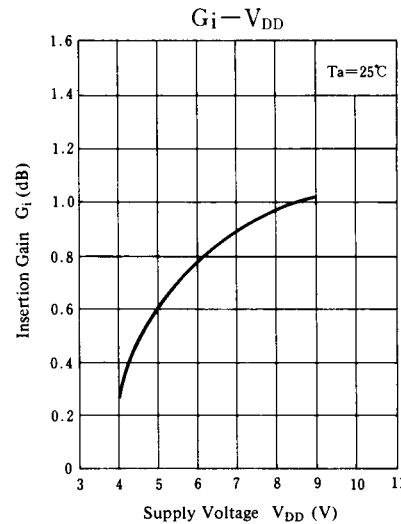
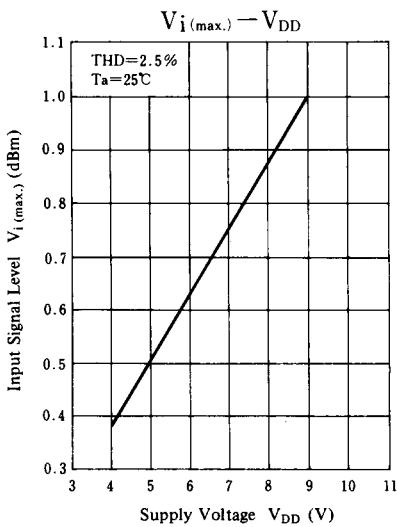
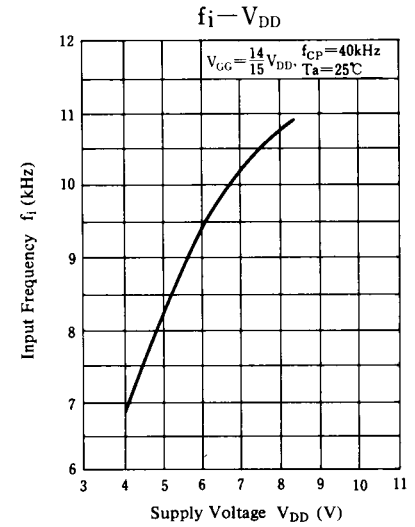
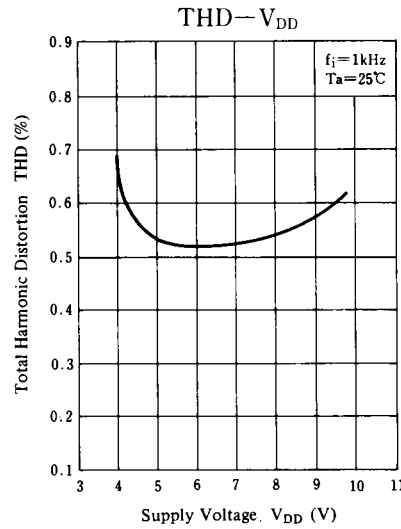
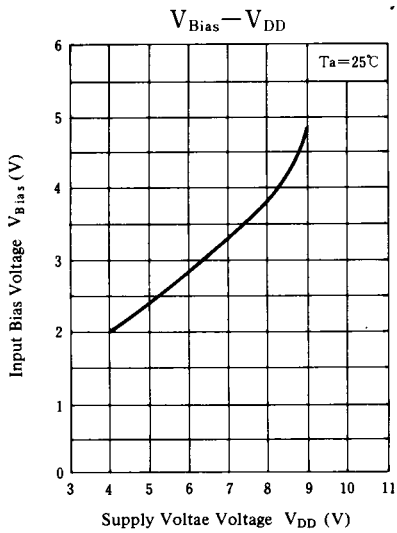

■ Application Circuit

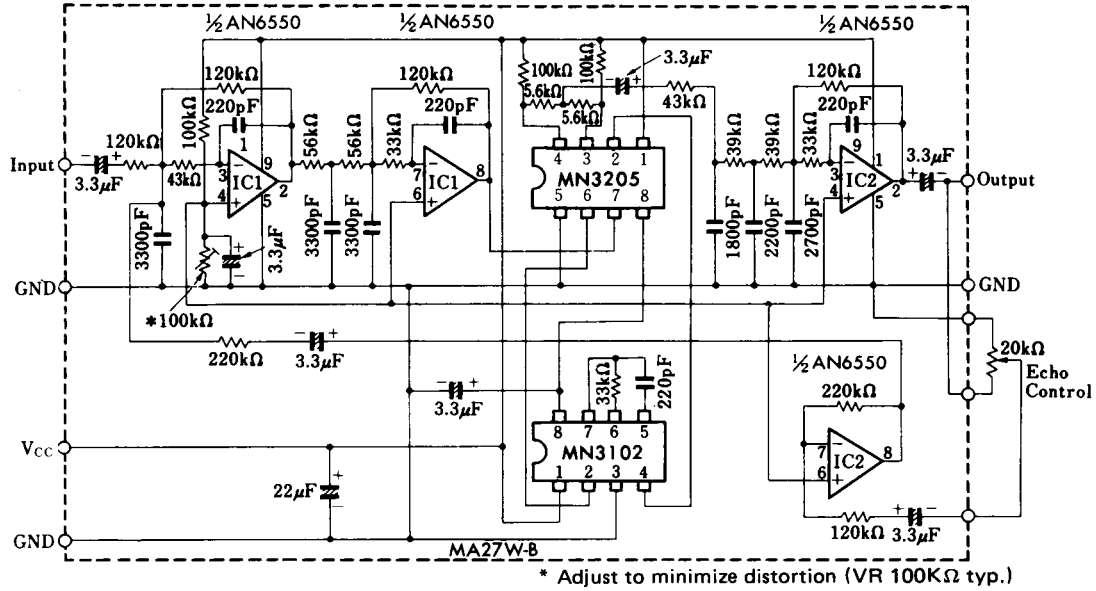

Reverberation Effect Generation Circuit (Signal Delay Over 100msec.)