



STPS2545CT/CG/CFP

POWER SCHOTTKY RECTIFIER

MAIN PRODUCT CHARACTERISTICS

$I_{F(AV)}$	2 x 12.5 A
V_{RRM}	45 V
$T_j(\text{max})$	175 °C
$V_F(\text{max})$	0.57 V

FEATURES AND BENEFITS

- VERY SMALL CONDUCTION LOSSES
- NEGLIGIBLE SWITCHING LOSSES
- EXTREMELY FAST SWITCHING
- LOW THERMAL RESISTANCE
- AVALANCHE CAPABILITY SPECIFIED

DESCRIPTION

Dual center tap Schottky rectifier suited for Switch Mode Power Supplies and high frequency DC to DC converters.

This device is especially intended for use in low voltage, high frequency inverters, free wheeling and polarity protection applications.

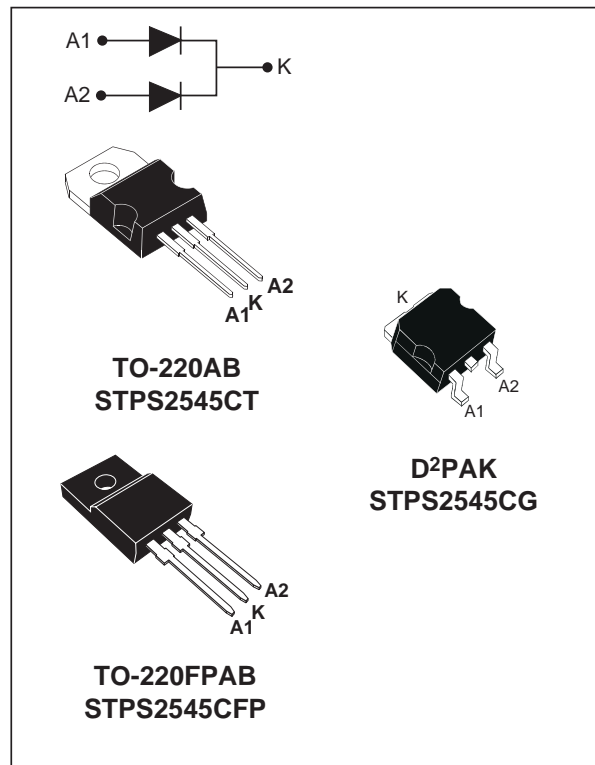

ABSOLUTE RATINGS (limiting values, per diode)

Symbol	Parameter			Value	Unit	
V_{RRM}	Repetitive peak reverse voltage			45	V	
$I_{F(RMS)}$	RMS forward current			30	A	
$I_{F(AV)}$	Average forward current $\delta = 0.5$	TO-220AB	$T_c = 160^\circ\text{C}$	Per diode	12.5	A
		D ² PAK				
		TO-220FPAB	$T_c = 140^\circ\text{C}$	Per device	25	
I_{FSM}	Surge non repetitive forward current		$t_p = 10 \text{ ms}$ sinusoidal	200	A	
I_{RRM}	Repetitive peak reverse current		$t_p = 2 \mu\text{s}$ square $F = 1 \text{ kHz}$	1	A	
I_{RSM}	Non repetitive peak reverse current		$t_p = 100 \mu\text{s}$ square	2	A	
P_{ARM}	Repetitive peak avalanche power		$t_p = 1 \mu\text{s}$ $T_j = 25^\circ\text{C}$	4800	W	
T_{stg}	Storage temperature range			-65 to +175	°C	
T_j	Maximum operating junction temperature *			175	°C	
dV/dt	Critical rate of rise of reverse voltage			10000	V/ μs	

* : $\frac{dP_{tot}}{dT_j} < \frac{1}{R_{th(j-a)}}$ thermal runaway condition for a diode on its own heatsink

STPS2545CT/CG/CFP

THERMAL RESISTANCES

Symbol	Parameter		Value	Unit	
R _{th(j-c)}	Junction to ambient	TO-220AB / D ² PAK	Per diode	1.6	°C/W
		TO-220FPAB		4	
		TO-220AB / D ² PAK	Total	1.1	°C/W
		TO-220FPAB		3.5	
R _{th(c)}		TO-220AB / D ² PAK	Coupling	0.6	°C/W
		TO-220FPAB		3	

When the diodes 1 and 2 are used simultaneously :
 $\Delta T_j(\text{diode 1}) = P(\text{diode 1}) \times R_{th(j-c)}(\text{Per diode}) + P(\text{diode 2}) \times R_{th(c)}$

STATIC ELECTRICAL CHARACTERISTICS (per diode)

Symbol	Parameter	Tests Conditions		Min.	Typ.	Max.	Unit
I _R *	Reverse leakage Current	T _j = 25°C	V _R = V _{RRM}			125	μA
		T _j = 125°C			9	25	mA
V _F *	Forward Voltage drop	T _j = 125°C	I _F = 12.5 A		0.50	0.57	V
		T _j = 25°C	I _F = 25 A			0.84	
		T _j = 125°C	I _F = 25 A		0.65	0.72	

Pulse test : * t_p = 380 μs, δ < 2%

To evaluate the conduction losses use the following equation :

$$P = 0.42 \times I_{F(AV)} + 0.012 \times I_{F(RMS)}^2$$

Fig. 1: Conduction losses versus average current.

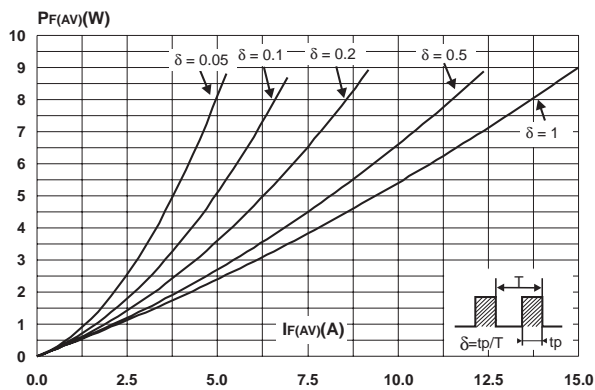

Fig. 3: Normalized avalanche power derating versus pulse duration.

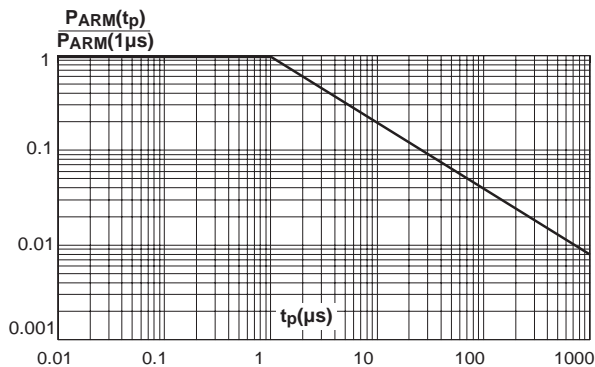

Fig. 2: Average forward current versus ambient temperature (δ=0.5).

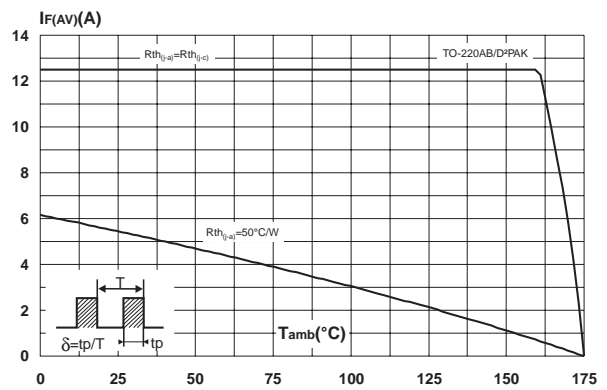

Fig. 4: Normalized avalanche power derating versus junction temperature.

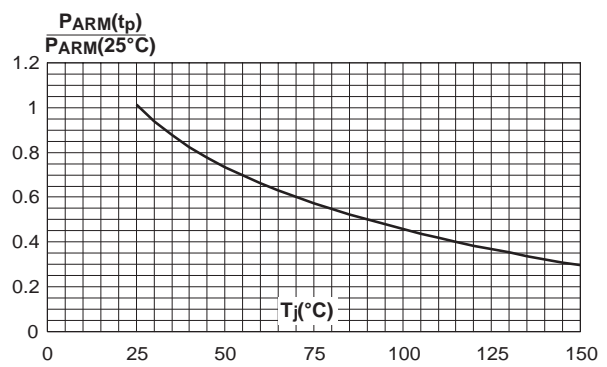

Fig. 5-1: Non repetitive surge peak forward current versus overload duration (maximum values) (TO-220AB, D²PAK).

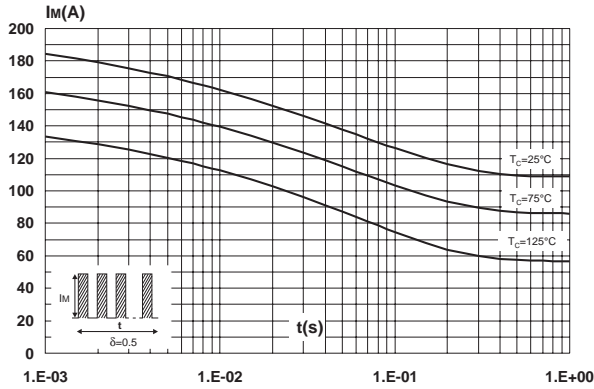

Fig. 5-2: Non repetitive surge peak forward current versus overload duration (maximum values) (TO-220FPAB).

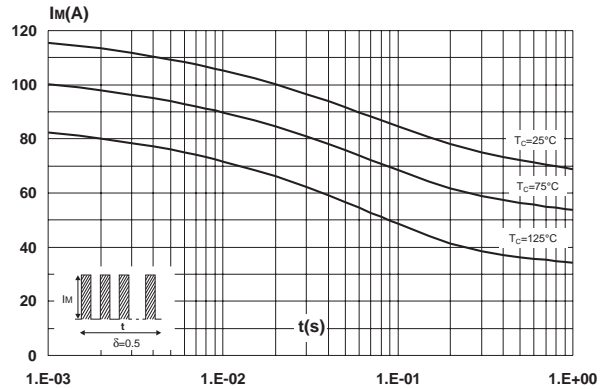

Fig. 6-1: Relative variation of thermal impedance junction to case versus pulse duration (TO-220AB, D²PAK).

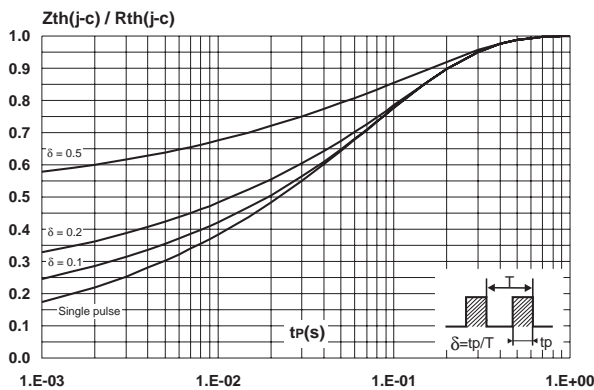

Fig. 6-2: Relative variation of thermal impedance junction to case versus pulse duration (TO-220FPAB).

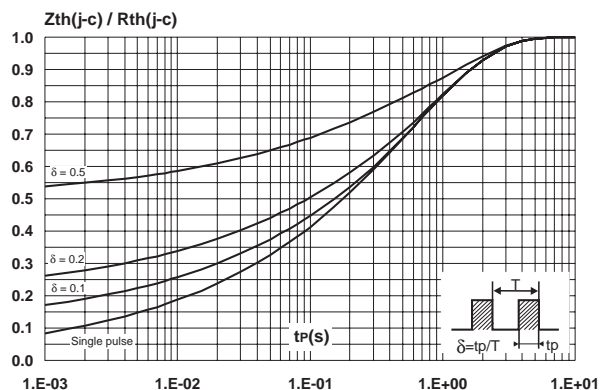

Fig. 7: Reverse leakage current versus reverse voltage applied (typical values).

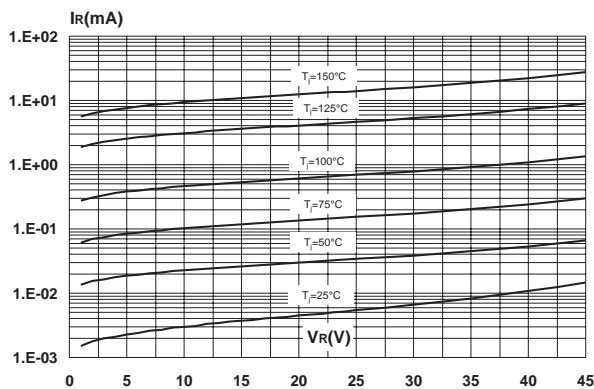
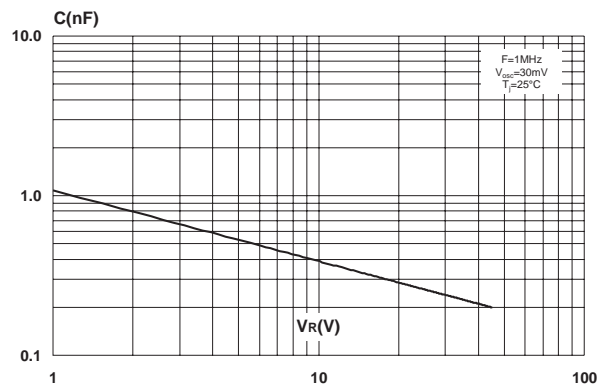

Fig. 8: Junction capacitance versus reverse voltage applied (typical values).



STPS2545CT/CG/CFP

Fig. 9: Forward voltage drop versus forward current.

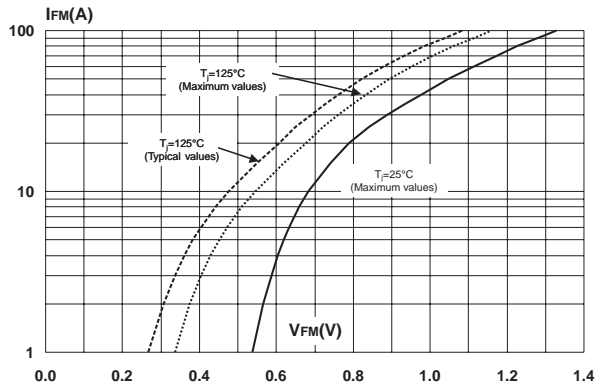
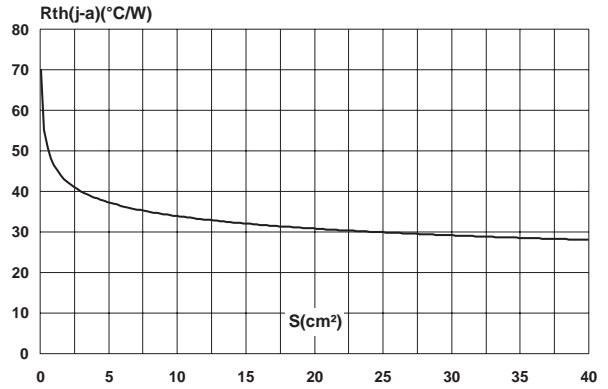
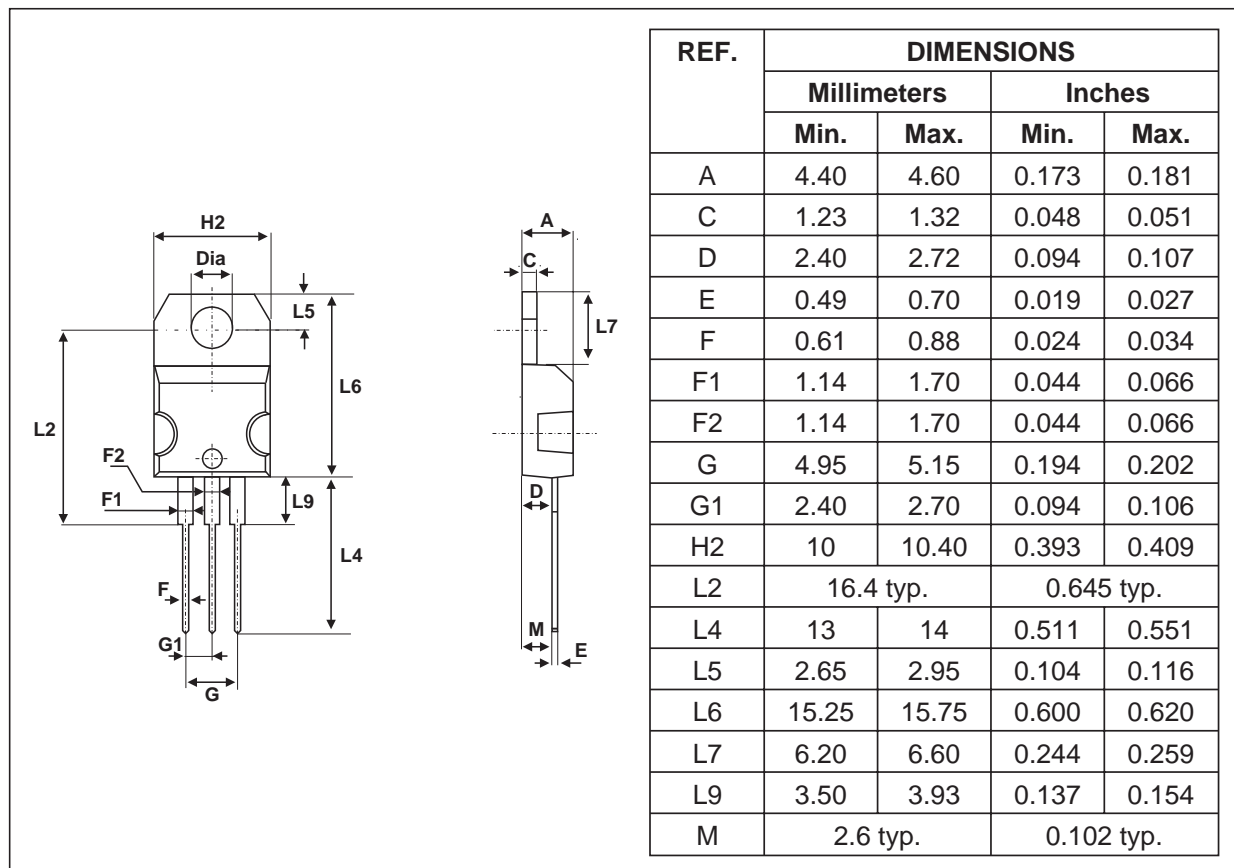

Fig. 10: Thermal resistance junction to ambient versus copper surface under tab (epoxy printed board FR4, Cu = 35µm).



PACKAGE MECHANICAL DATA
TO-220AB



PACKAGE MECHANICAL DATA
D²PAK

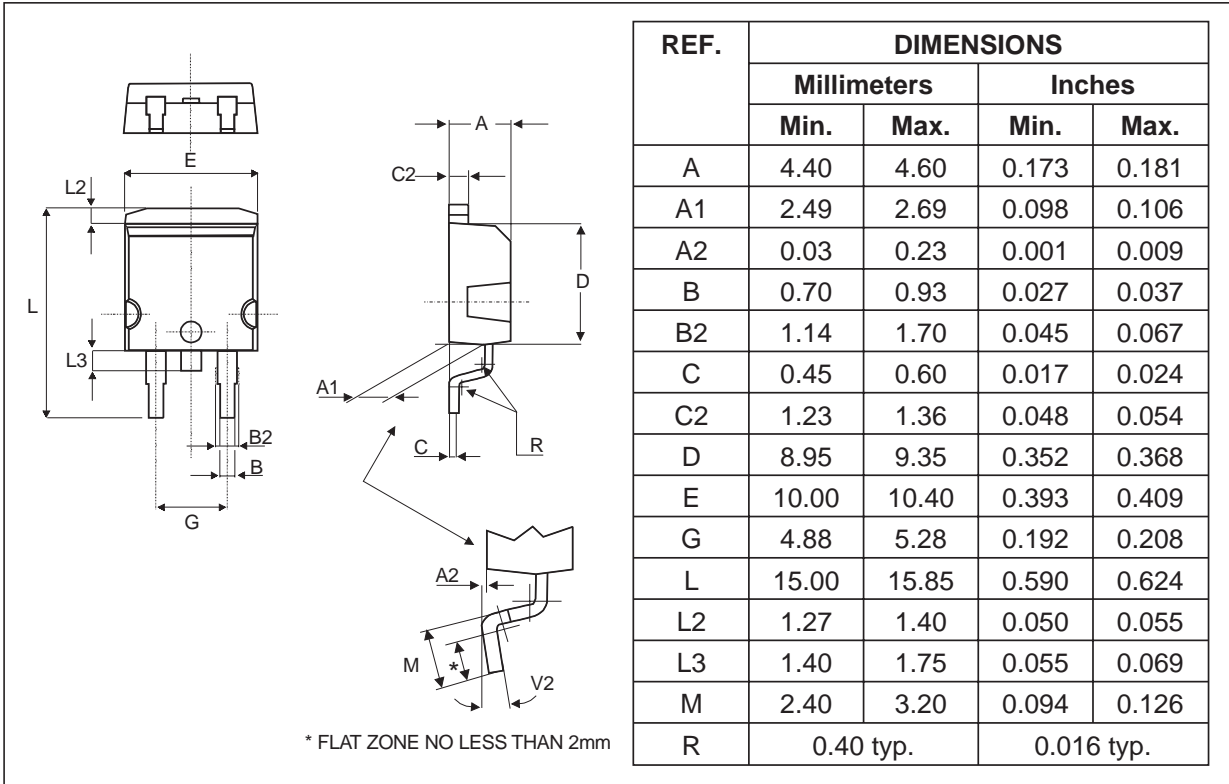

FOOTPRINT

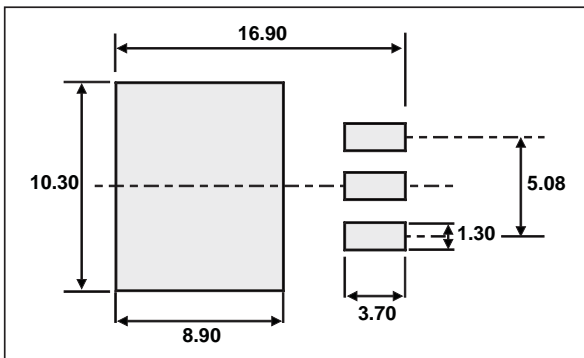

STPS2545CT/CG/CFP

PACKAGE MECHANICAL DATA
TO-220FPAB

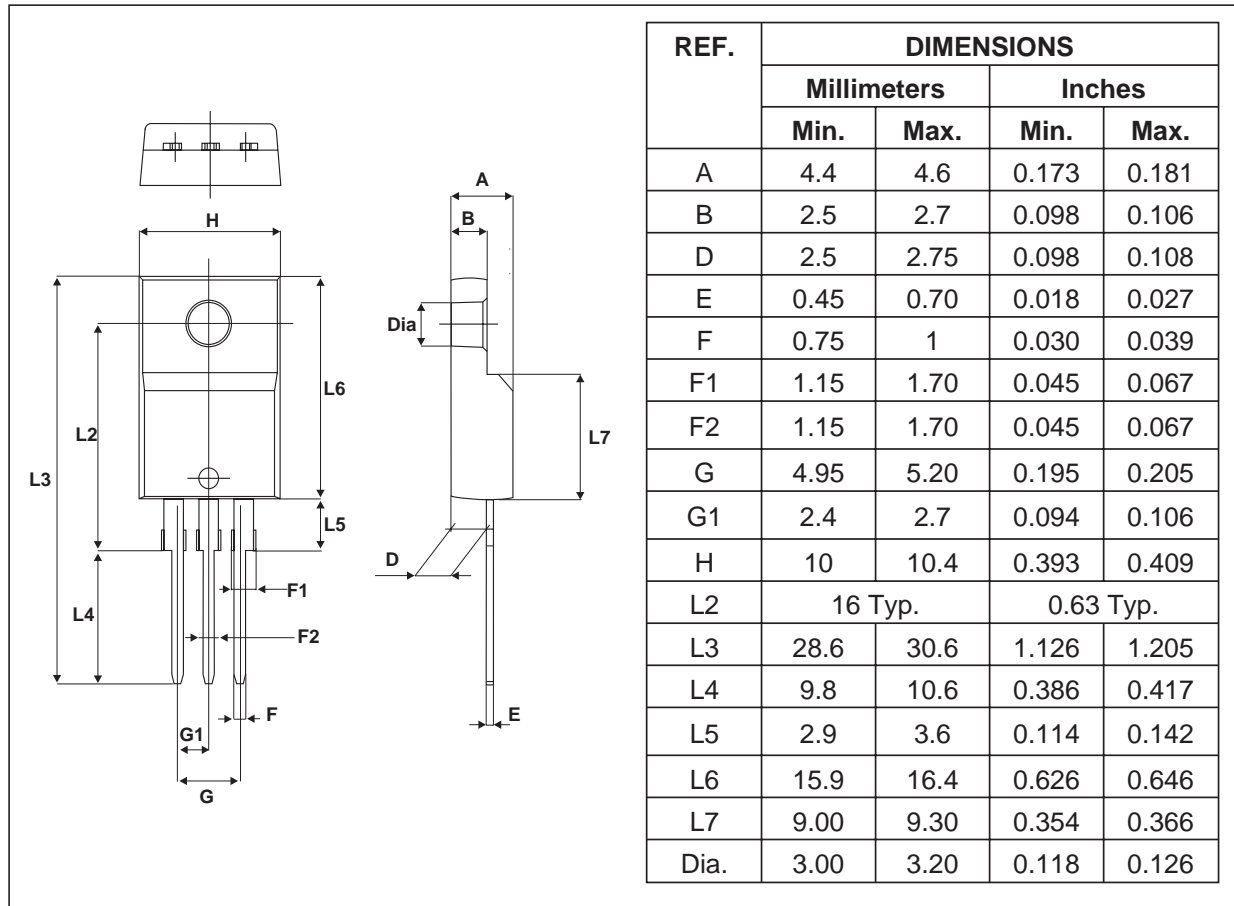

Ordering type	Marking	Package	Weight	Base qty	Delivery mode
STPS2545CT	STPS2545CT	TO-220AB	2.20 g	50	Tube
STPS2545CFP	STPS2545CFP	TO-220FPAB	2.0 g	50	Tube
STPS2545CG	STPS2545CG	D ² PAK	1.48 g	50	Tube
STPS2545CG-TR	STPS2545CG	D ² PAK	1.48 g	1000	Tape & reel

■ EPOXY MEETS UL94, V0

Information furnished is believed to be accurate and reliable. However, STMicroelectronics assumes no responsibility for the consequences of use of such information nor for any infringement of patents or other rights of third parties which may result from its use. No license is granted by implication or otherwise under any patent or patent rights of STMicroelectronics. Specifications mentioned in this publication are subject to change without notice. This publication supersedes and replaces all information previously supplied. STMicroelectronics products are not authorized for use as critical components in life support devices or systems without express written approval of STMicroelectronics.

The ST logo is a registered trademark of STMicroelectronics

© 2003 STMicroelectronics - Printed in Italy - All rights reserved.

STMicroelectronics GROUP OF COMPANIES

Australia - Brazil - Canada - China - Finland - France - Germany
Hong Kong - India - Israel - Italy - Japan - Malaysia - Malta - Morocco - Singapore
Spain - Sweden - Switzerland - United Kingdom - United States.

<http://www.st.com>

