

500mA Regulator Monolithic IC MM156□□F

Outline

This IC is a small, stable power supply with output voltage precision of $\pm 2\%$ (when $I_o = 250\text{mA}$), maximum output current of 500mA, and I/O voltage difference of 0.3V typ. at 250mA. Output noise reduction and output ON/OFF control pins are provided, making it ideal for portable equipment.

Features

- | | |
|--------------------------------|--|
| 1. No-load current consumption | 1.9mA typ. |
| 2. I/O voltage difference | 0.3V typ. ($I_o=250\text{mA}$) |
| 3. Ripple rejection rate | 64dB typ. ($f=120\text{Hz}$, $V_{\text{RIPPLE}}=1\text{VP-P}$, $I_o=250\text{mA}$) |
| 4. Output current | 500mA max. |
| 5. Output noise voltage | 75 μVrms typ. |
| 6. Output voltage rank | 1.5 ~ 5.0V (0.1V steps) |
| 7. Output ON/OFF control | High→ON, Low→OFF |

Package

SOP-7B

Applications

1. Cordless telephone
2. Portable equipment, etc.

Pin Assignment

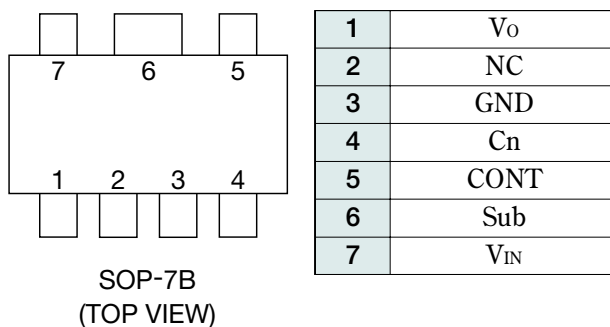

Equivalent Circuit Diagram

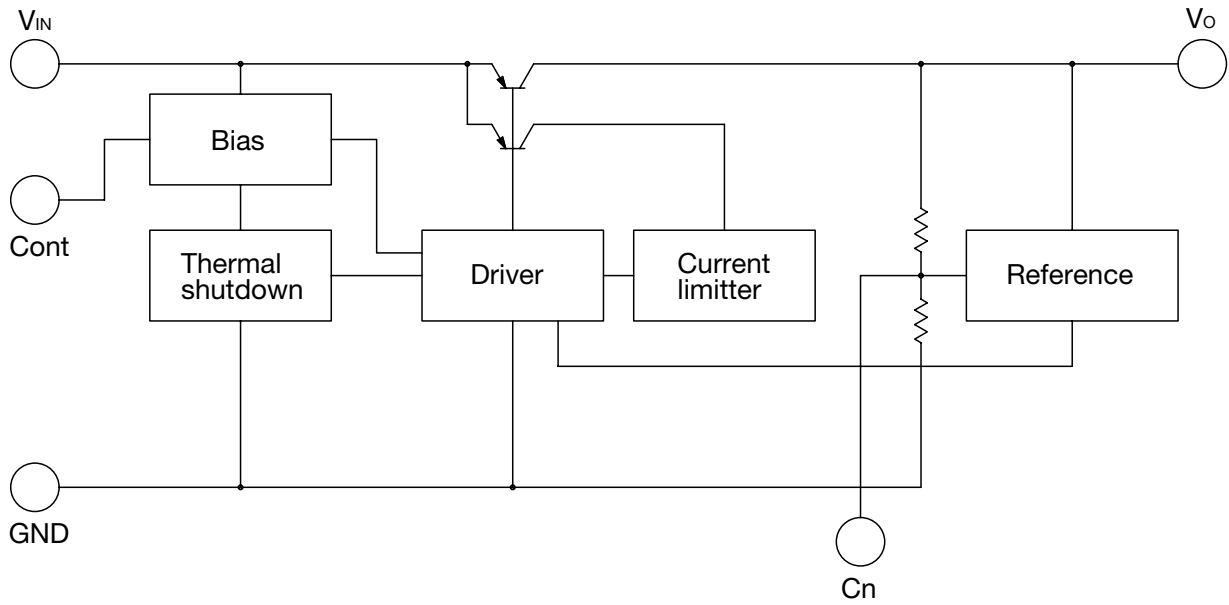

Pin Description

Pin No.	Pin name	Function	Internal equivalent circuit diagram
1	V _{OUT}	Output pin	
2	NC	No connection	
3	GND	Ground	
4	C _n	Noise decrease pin	

Pin No.	Pin name	Function	Internal equivalent circuit diagram						
5	CONT	Control pin <table border="1" style="margin-left: 20px;"> <tr> <td>COUT</td> <td>Output</td> </tr> <tr> <td>H</td> <td>ON</td> </tr> <tr> <td>L</td> <td>OFF</td> </tr> </table>	COUT	Output	H	ON	L	OFF	
COUT	Output								
H	ON								
L	OFF								
6	Sub	Substrate The 6pin must be connected to GND.							
7	V _{IN}	Input pin							

Absolute Maximum Ratings (Ta=25°C)

Item	Symbol	Ratings	Units
Storage temperature	T _{STG}	-40~+150	°C
Supply voltage	V _{IN}	-0.3~+12	V
Allowable loss	P _d	400 (Not attached) 950 (*1)	mW

*1 With the double sided PC Board of glass epoxy
(Copper plane 80%, 192X142X1.2mm)

Recommended Operating Conditions

Item	Symbol	Ratings	Units
Operating temperature	T _{OPR}	-30~+85	°C
Output current	I _{OUT}	0~500	mA
Operating voltage	V _{OP}	V _o Typ.+0.5~+10	V

Electrical Characteristics 1 (Except where noted otherwise, Ta=25°C, Vcc=9V)

Item	Symbol	Measurement conditions	Min.	Typ.	Max.	Units
No-Load input current	I _{CC}	I _o =0mA		1.9	5	mA
Input current (OFF)	I _{CCOFF}	V _{CONT} =0V		0	1	μA
Output voltage *3	V _{OUT}	I _o =250mA	×0.98		×1.02	V
Dropout voltage *4	V _{IO}	V _{IN} =V _O -0.2V, I _o =250mA		0.3	0.5	V
Line regulation	ΔV1	V _{IN} =V _O +1.5~V _O +2.5V, I _o =250mA		10	20	mV
Load regulation	ΔV2	I _o =0~250mA		20	120	mV
V _{OUT} temperature coefficient *2	ΔV _{OUT} /ΔT	T _j =-30~+85°C		100		ppm/°C
Ripple rejection *2	RR	f=120Hz V _{RIPPLE} =1V, I _o =250mA	50	64		dB
Output noise voltage *2	V _n	fBW=20~80kHz C _n =470pF		75		μV _{rms}
CONT pin input current	I _{CONT}	V _{CONT} =V _{IN}	10	20	30	μA
CONT pin high threshold level	V _{CONTH}		1.6		V _{IN} +0.3	V
CONT pin low threshold level	V _{CONTL}		-0.3		0.4	V

*2. The parameter is guaranteed by design.

*3. Please refer to another page.

*4. The parameter is not guaranteed in the model less than V_{OUT}=2V.

Electrical Characteristics 2

Output Voltage

Product name	Test conditions	Output voltage			
		Min.	Typ.	Max.	
MM1561F	I _o =250mA	1.470	1.5	1.530	
MM1561G		1.568	1.6	1.632	
MM1561H		1.666	1.7	1.734	
MM1561J		1.764	1.8	1.836	
MM1561K		1.862	1.9	1.938	
MM1562A		1.960	2.0	2.040	
MM1562B		2.058	2.1	2.142	
MM1562C		2.156	2.2	2.244	
MM1562D		2.254	2.3	2.346	
MM1562E		2.352	2.4	2.448	
MM1562F		2.450	2.5	2.550	
MM1562G		2.548	2.6	2.652	
MM1562H		2.646	2.7	2.754	
MM1562J		2.744	2.8	2.856	
MM1562K		2.842	2.9	2.958	
MM1563A		2.940	3.0	3.060	
MM1563B		3.038	3.1	3.162	
MM1563C		3.136	3.2	3.264	
MM1563D		3.234	3.3	3.366	
MM1563E		3.332	3.4	3.468	
MM1563F		3.430	3.5	3.570	
MM1563G		3.528	3.6	3.672	
MM1563H		I _o =250mA	3.626	3.7	3.774
MM1563J			3.724	3.8	3.876
MM1563K			3.822	3.9	3.978
MM1564A			3.920	4.0	4.080
MM1564B			4.018	4.1	4.182
MM1564C			4.116	4.2	4.284
MM1564D	4.214		4.3	4.386	
MM1564E	4.312		4.4	4.488	
MM1564F	4.410		4.5	4.590	
MM1564G	4.508		4.6	4.692	
MM1564H	4.606	4.7	4.794		
MM1564J	4.704	4.8	4.896		
MM1564K	4.802	4.9	4.998		
MM1565A	4.900	5.0	5.100		

Measuring Circuit

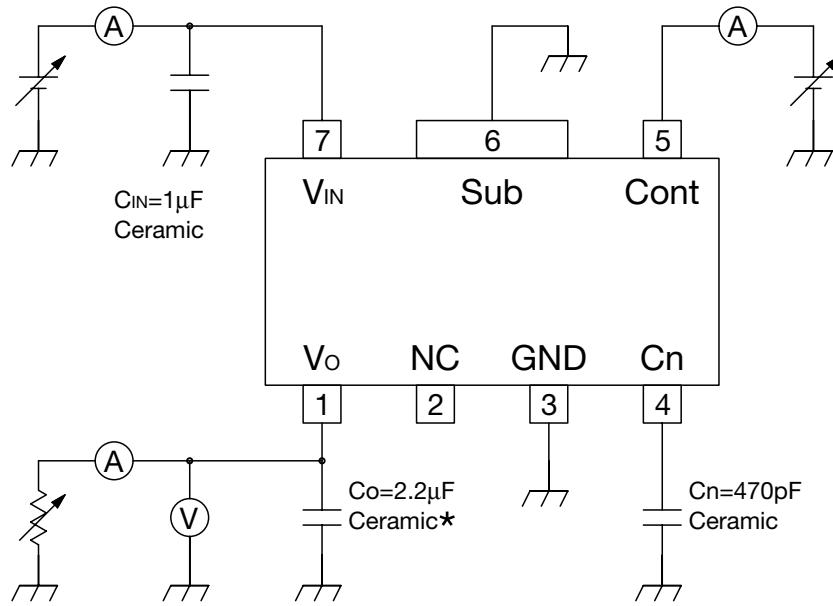

Application Circuit

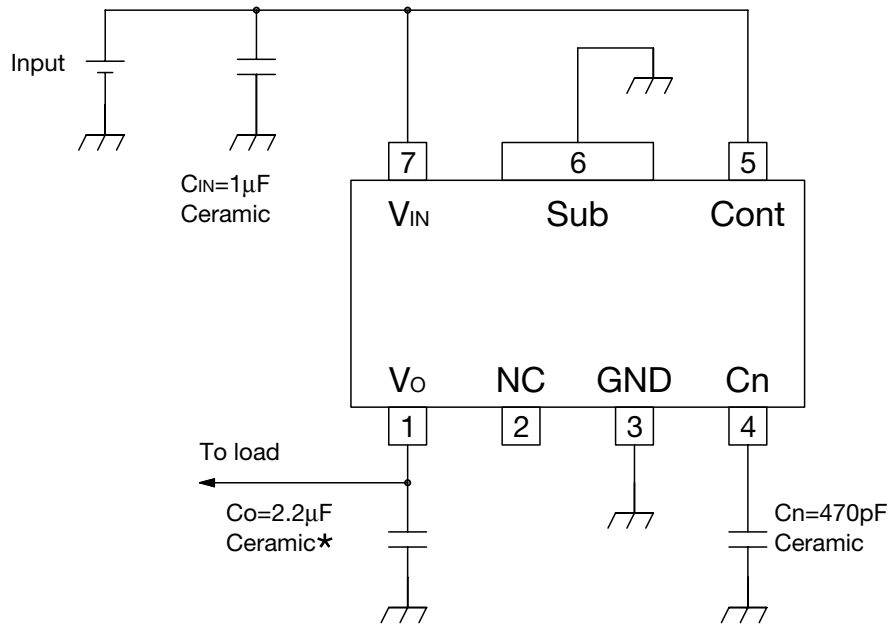

*Temperature Characteristics: B Type

Note

1. The output capacitor is required between output and GND to prevent oscillation.
2. Use a capacitance that is within the ESR characteristics stable range for output capacity.
It is possible to use a ceramic capacitor without ESR resistance for output.
The ceramic capacitor must be used more than 2.2µF and B type temperature characteristics.
3. The wire of Vcc and GND is required to print full ground plane for noise and stability.
4. The input capacitor must be connected a distance of less than 1cm from input pin.
5. The capacitor is connected to Cn must have low leakage current characteristics, because Cn pin is high impedance.
6. The 6pin (heat sink pin) must be connected to GND. This pin can be only connected to GND.
7. In case the output voltage is above the input voltage, the overcurrent flow by internal parasitic diode from output to input. In such application, the external bypass diode must be connected between output and input pin.

Characteristics (3.0V product Except where noted otherwise, $T_a=25^{\circ}\text{C}$, $V_{\text{IN}}=5\text{V}$, $V_{\text{CONT}}=5\text{V}$, $C_{\text{IN}}=1\mu\text{F}$, $C_{\text{O}}=2.2\mu$)

Output-Input Voltage

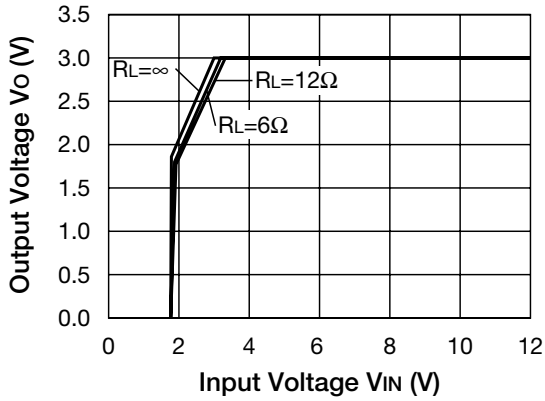

Input Current-Input Voltage

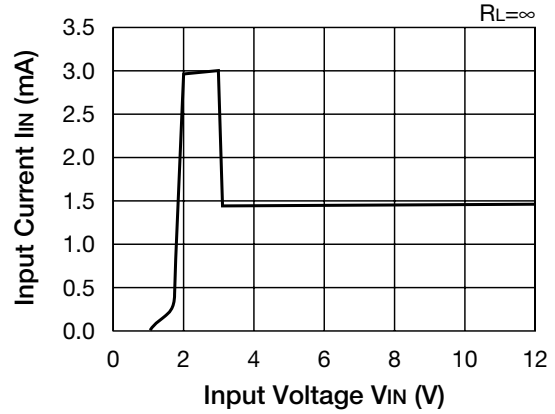

Load Regulation

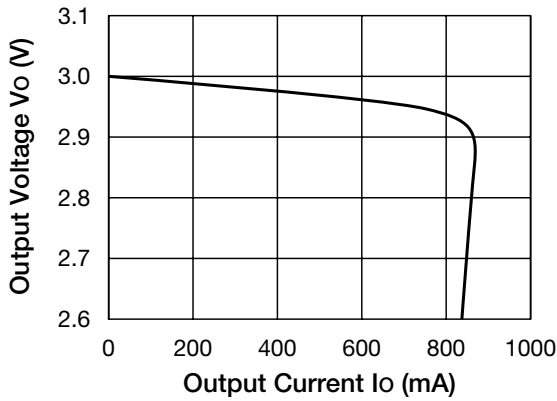

Line Regulation

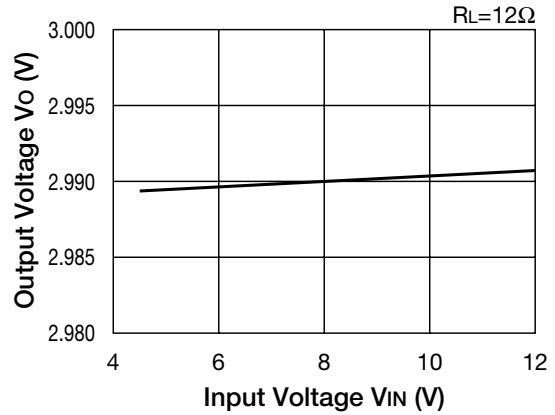

Dropout Voltage-Output Current

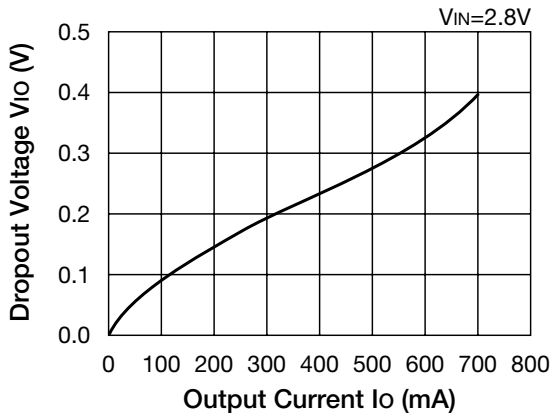

Output Voltage-Junction Temperature

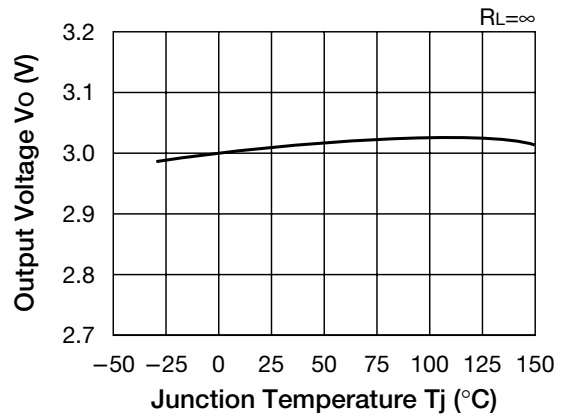

Ripple Rejection

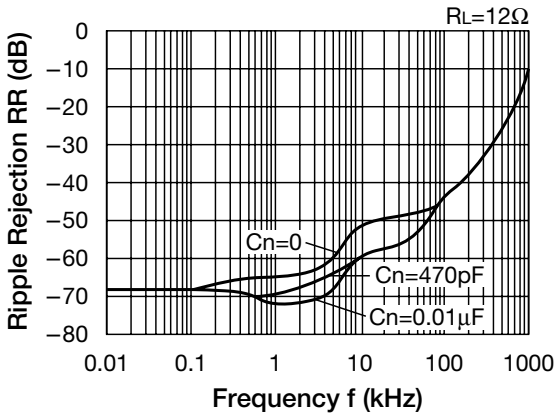

Output Noise

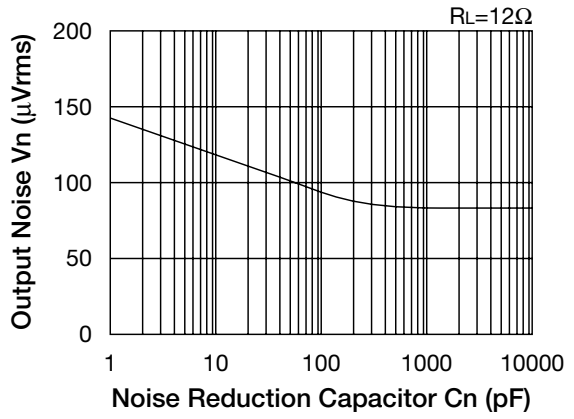

Current Limit Characteristics

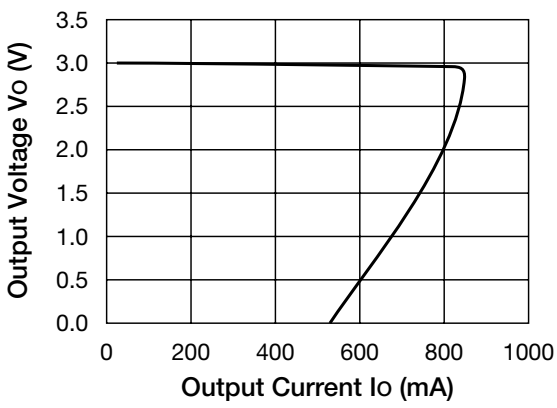

GND Pin Current

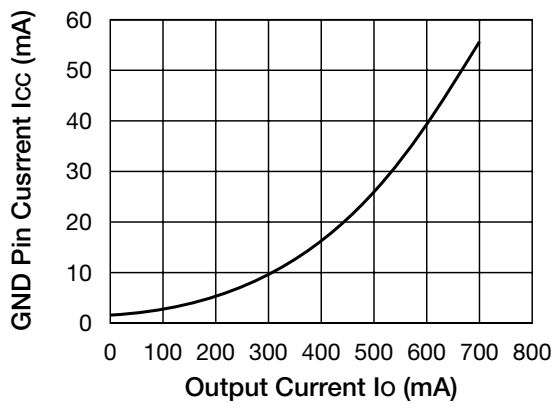

ESR Stability Area

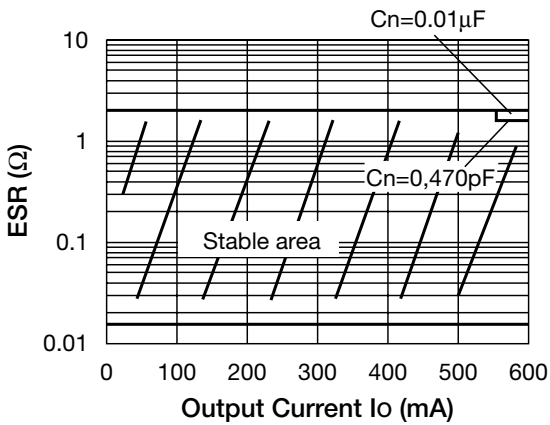

Power Dissipation

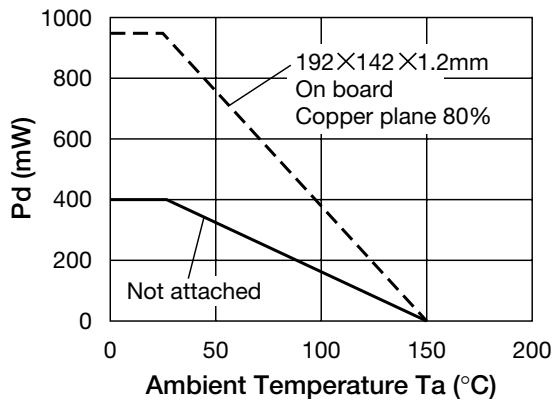

Characteristics (1.8V, 3.0V product Except where noted otherwise, $T_a=25^\circ\text{C}$, $V_{IN}=5\text{V}$, $V_{CONT}=5\text{V}$, $C_{IN}=1\mu\text{F}$, $C_O=2.2\mu$)

Load Regulation

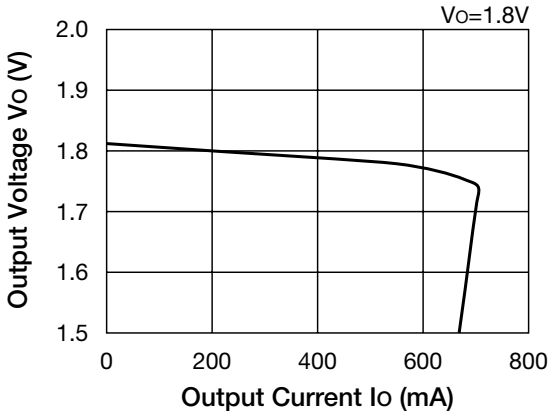

Load Regulation

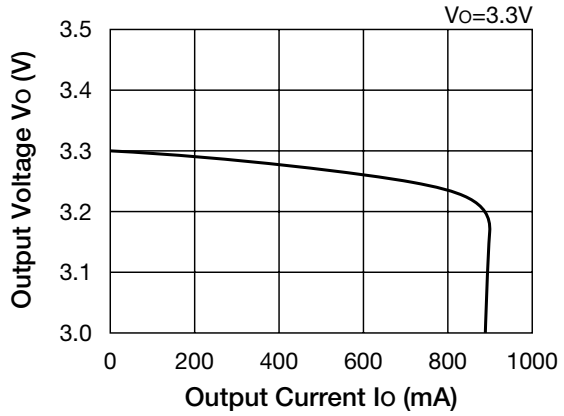

Output Voltage-Junction Temperature

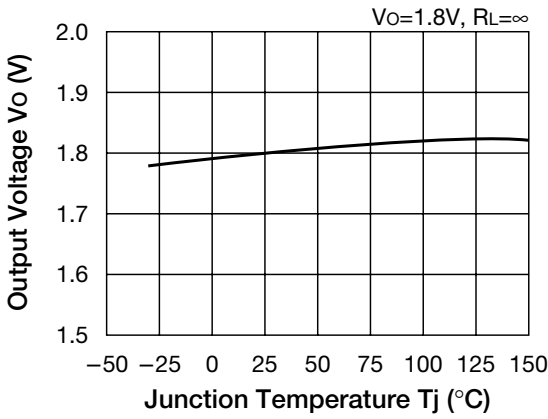

Output Voltage-Junction Temperature

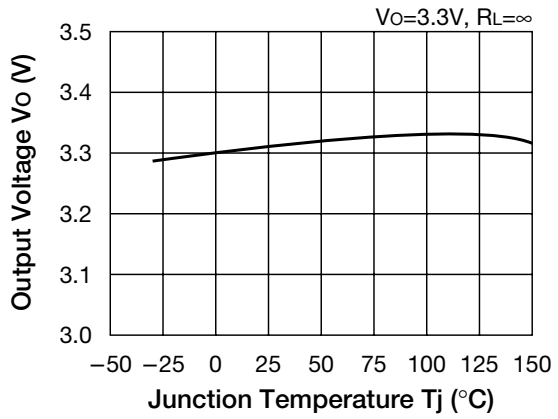

ESR Stability Area

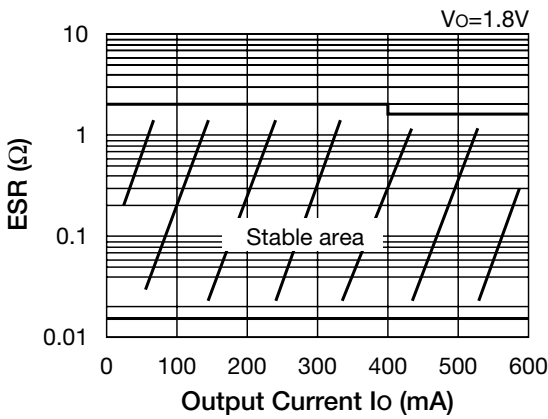

ESR Stability Area

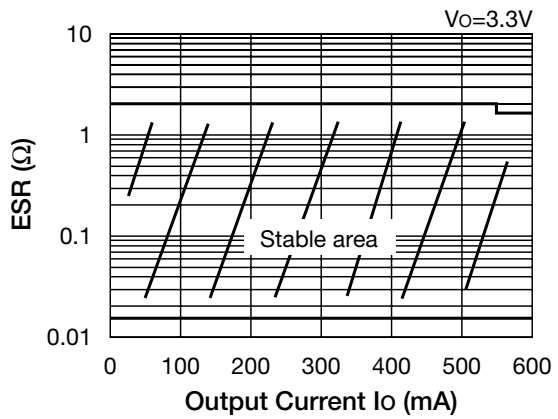

Characteristics (5.0V product Except where noted otherwise, $T_a=25^\circ\text{C}$, $V_{IN}=5\text{V}$, $V_{CONT}=5\text{V}$, $C_{IN}=1\mu\text{F}$, $C_O=2.2\mu$)

Load Regulation

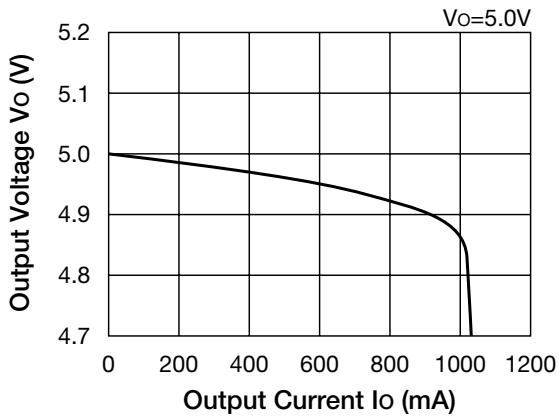

Output Voltage-Junction Temperature

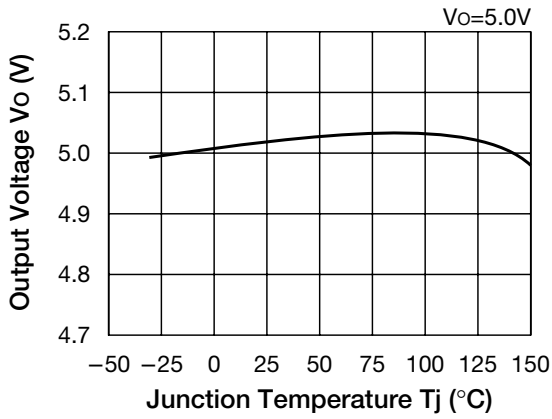

ESR Stability Area

