

PC317 Series

Opaque*, Mini-Flat Package, General Purpose Photocoupler

Features

1. Opaque type, mini-flat package
PC317 (1-channel) PC3D17 (2-channel)
PC3Q17 (4-channel)
2. Subminiature type
(The volume is smaller than that of our conventional DIP type by as far as 30%.)
3. Current transfer ratio
CTR: MIN. 50% at $I_F=5mA$, $V_{CE}=5V$
4. Isolation voltage between input and output
 $V_{ISO}: 2,500V_{rms}$

* Empolys double transfer mold technology.

Applications

1. Hybrid substrates that require high density mounting
2. Programmable controllers

Outline Dimensions

(Unit : mm)

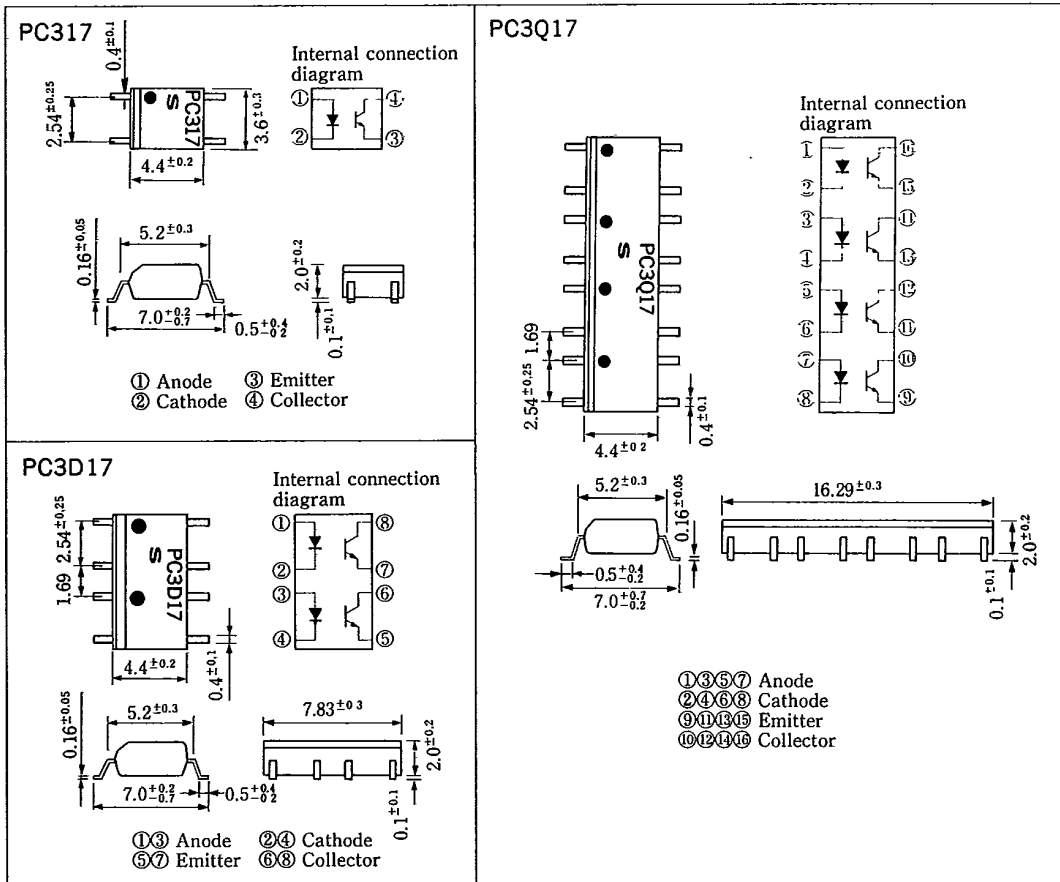

Fig. 2 Collector Power Dissipation vs. Ambient Temperature

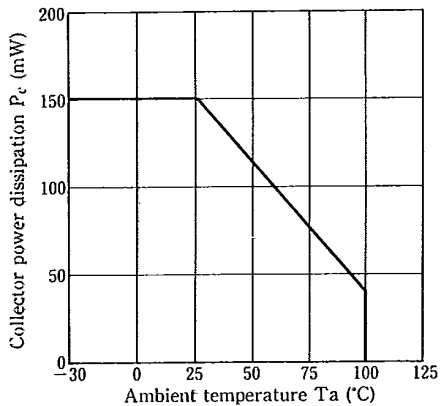

Fig. 3 Peak Forward Current vs. Duty Ratio

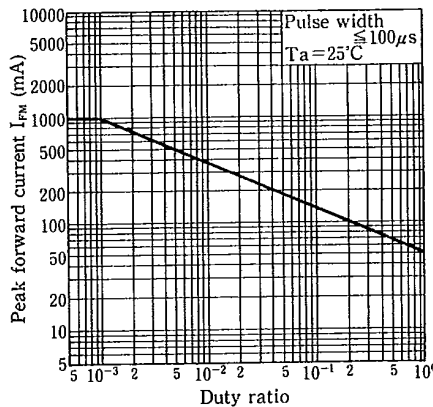

Fig. 4 Forward Current vs. Forward Voltage

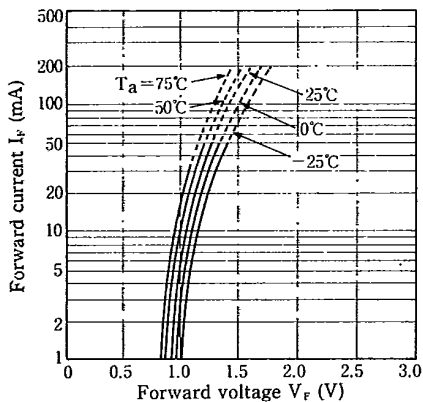

Fig. 5 Current Transfer Ratio vs. Forward Current

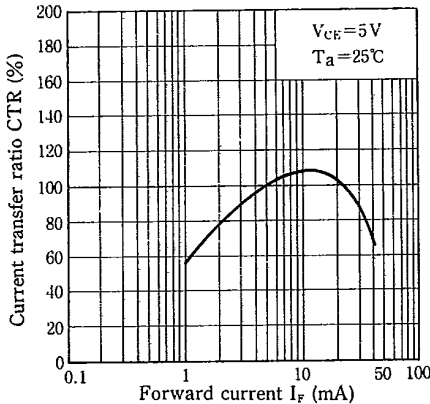

Fig. 6 Collector Current vs. Collector-emitter Voltage

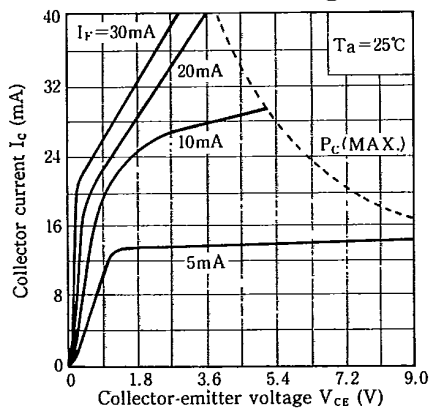

Fig. 7 Relative Current Transfer Ratio vs. Ambient Temperature

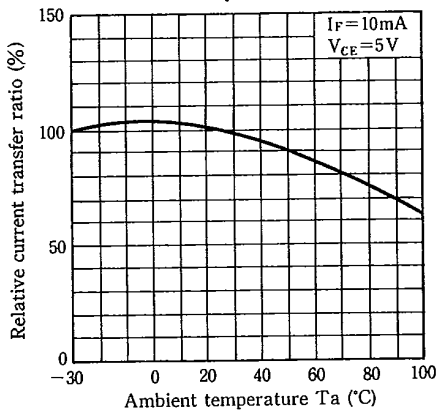

Fig. 8 Collector-emitter Saturation Voltage vs. Ambient Temperature

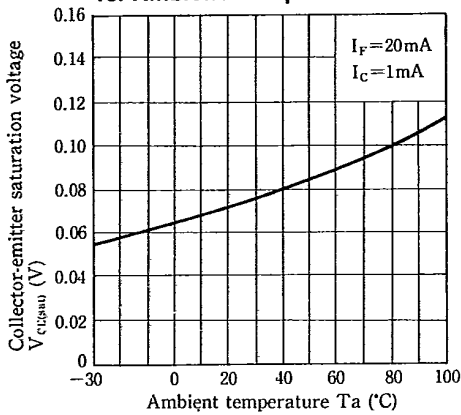

Fig. 9 Collector Dark Current vs. Ambient Temperature

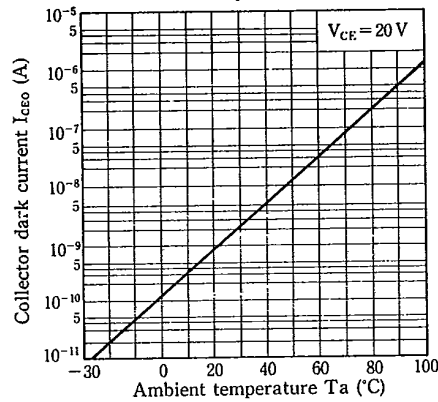

Fig. 10 Response Time vs. Load Resistance

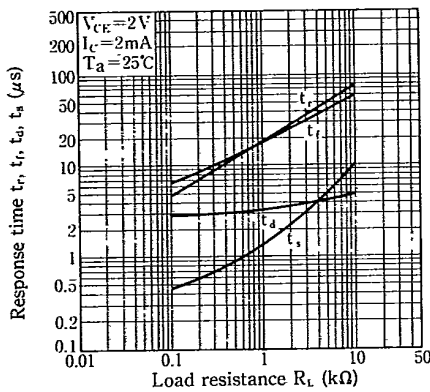
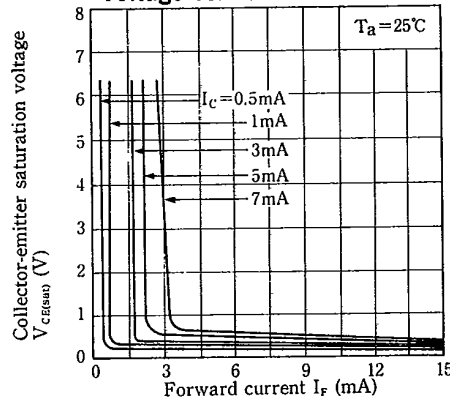
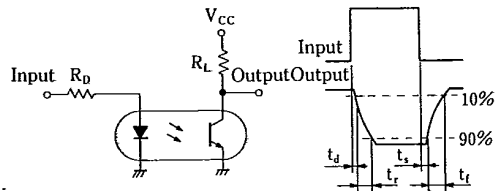

Fig. 11 Collector-emitter Saturation Voltage vs. Forward Current



Test Circuit for Response Time



Package Specification of PC300 Series (1-ch type)

Model No.	Sales Unit	Package Specifications	Diameter of Reel	Tape Width
PC3 * * Z	1 pc.	Sleeve package (Net: 125 pcs.)	—	—
PC3 * *	3,000 pcs.	Taping package (Net: 3,000 pcs.)	φ370mm	12mm
PC3 * T	750 pcs.	Taping package (Net: 750 pcs.)	φ178mm	12mm

6